

Active Vapor Split Control for Dividing-Wall Columns

Deeptanshu Dwivedi,[†] Jens P. Strandberg,^{†,§} Ivar J. Halvorsen,[‡] Heinz A. Preisig,[†] and Sigurd Skogestad^{*,†}

[†]Department of Chemical Engineering, Norwegian University of Science and Technology, Trondheim, Norway

[‡]Applied Cybernetics, SINTEF, Trondheim, Norway

ABSTRACT: Dividing-wall distillation columns offer large potential energy savings over conventional column sequences, typically up to 30% for three-product (Petlyuk) columns and 40% for four-product (Kaibel) columns. However, the energy required for a separation depends on using an optimal vapor split. Hence, the energy saving potential may be lost if the column is operated away from its optimal point, for example, due to feed composition changes. This work demonstrates experimentally that the vapor split can be effectively used as a degree of freedom during operation, for example, for temperature control in the prefractionator section. Together with an adjustable liquid split, the vapor split control allows for minimizing the energy requirements.

INTRODUCTION

Dividing-wall distillation columns such as Petlyuk arrangements and the Kaibel column, shown in Figure 1 offer large capital and

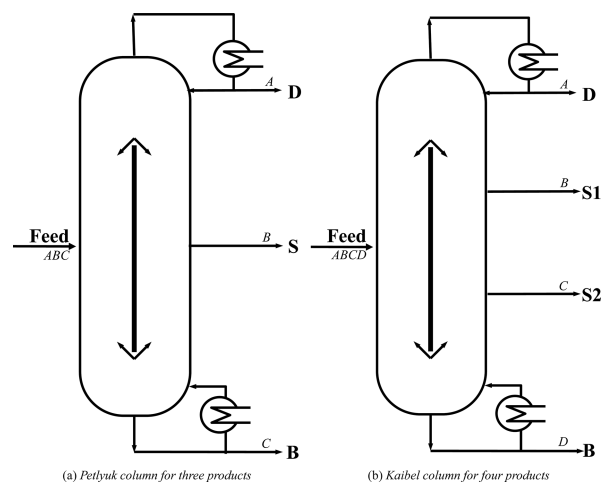

Figure 1. Dividing-wall columns with prefractionator section to the left of the dividing wall and the “main” column section to the right.

energy saving potentials compared to conventional schemes.^{1–3} Their control and operation, however, remains a challenge. For three-product separation, the energy savings can be up to 30% using a standard dividing-wall (Petlyuk) column with a single side stream (Figure 1a). The Kaibel column with two side streams (Figure 1b) can give up to 40% energy savings for four-product separation. However, the energy saving potential can be lost if the column is operated away from the optimum vapor split ratio (see Figure 2). Thus, the flexibility in operation of such systems at minimum energy over a large range of feed conditions or product specifications can be restricted by the absence of an active vapor split during operation.

Dividing-wall columns have been successfully implemented industrially, mainly at BASF.⁴ In the academic community, several works have been reported on operation and control of three-product Petlyuk columns.^{5–11} However, all earlier works

exclude the use of vapor split as a degree of freedom. Therefore, Agrawal and Fidkowski¹² suggested as an alternative to use a vapor side draw. Another alternative is to use the feed enthalpy as a degree of freedom, where the vapor fraction or degree of subcooling in the feed is varied to achieve optimum operation.¹³ However, these solutions usually come with a penalty on the energy requirement. The vapor split, however, comes with no suboptimal operation with respect to the energy requirement. Therefore, in this work, we consider the vapor split is always a potential degree of freedom.

To motivate the need for an active vapor split in dividing-wall columns further, we first consider some simulation results. Halvorsen and Skogestad¹³ studied steady state optimal operation of a three-product Petlyuk column. They reported that there may be a narrow operating window with respect to various degrees of freedom for operation of such a system at minimum energy. The control system should carefully designed to operate within this range to ensure operation at minimum energy. Further, this operating window may change in the presence of various disturbances such as feed composition and feed vapor fraction.

We confirm these results with a simulation study on a three-product Petlyuk column separating an equimolar saturated liquid feed of methanol, ethanol and propanol (Figure 2a). The Wilson model is used for the vapor–liquid equilibria and we assume constant molar overflow. For the given purity specifications, the boilup is minimum ($V/F = 1.33$) for a vapor split ratio (R_V) of 0.37. In Figure 2a, we plot the minimum boilup (V/F) required as the vapor split ratio is fixed at values different from its optimum value of 0.37. By “minimum”, we mean that the liquid split (R_L) has been adjusted so that the boilup is minimized for each R_V .

A similar simulation study for a four-product Kaibel column is shown in Figure 2b. We study an equimolar feed of methanol, ethanol, propanol, and *n*-butanol with a 50% vapor fraction.

Received: May 31, 2012

Revised: October 20, 2012

Accepted: October 20, 2012

Published: October 22, 2012

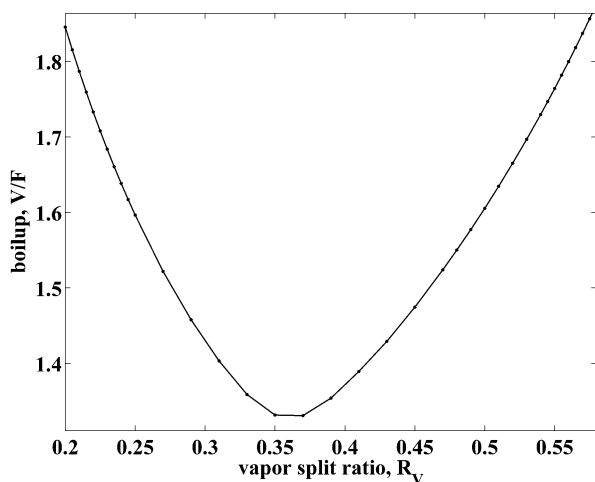

(a) Three-product Petlyuk column: Boilup (V/F) vs Vapor Split Ratio (R_V)

Data: Equimolar feed of methanol, ethanol and propanol with zero vapor fraction
 Purities (mol %): 97.6 % (D), 97.3 % (S); 99.6 % (B)
 Stages: 40 in prefractionator and 80 in main column (including top and bottom sections).
 Liquid split (R_L) has been optimized for each value of Vapor split (R_V)

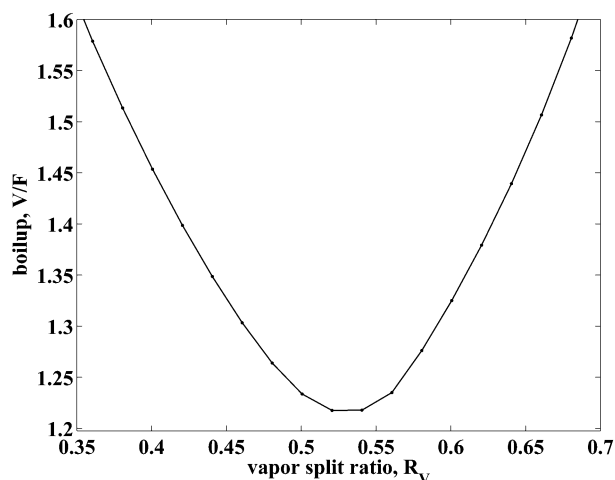

(b) Four-product Kaibel column: Boilup (V/F) vs Vapor Split Ratio (R_V)

Data: Equimolar feed of methanol, ethanol, propanol and *n*-butanol with 50 % vapor fraction
 Purities (mol %): 98.9 % (D); 98.0 % (S1); 98.0 % (S2); 99.8 % (B)
 Stages: 40 in prefractionator and 100 in main column
 Liquid split (R_L) has been optimized for each value of Vapor split (R_V)

Figure 2. Effect of vapor split ratio (R_V) on boilup (V/F) for fixed purity specifications in dividing-wall columns. ($R_V \equiv$ fraction of vapor boilup that is sent to prefractionator from the main column).

Again the Wilson model is used for the vapor–liquid equilibria and we assume constant molar overflow. The boilup (V/F) is minimum for an optimum vapor split ratio of 0.52 and again increases in both directions. In summary, the simulation results

in Figure 2 show that the energy usage (boilup, V/F) is sensitive to the value of R_V , and this motivates the need for introducing the vapor split (R_V) as a degree of freedom during operation. Ghadrddan et al.¹⁴ concluded similarly that there is a narrow operating window for energy optimal operation of a four-product dividing-wall column with respect to vapor split for a given purity specification.

In this work we demonstrate the use of direct active manipulation of the vapor split using an experimental four-product Kaibel arrangement (Figure 3). The experimental column consists of separate sections (Figure 3a), but it is thermodynamically equivalent to a single-shell dividing-wall implementation (Figure 1b) as proposed by Kaibel.² Use of a dividing wall is usually the preferred solution at the industrial scale because of lower capital costs. The schemes in Figures 1b and 3 are thermodynamically equivalent if the heat exchange across the wall is negligible, and most industrial practitioners disregard this effect.

■ EXPERIMENTAL SETUP

Figure 3 shows a schematic of our experimental column which is thermodynamically equivalent to the dividing-wall arrangement for separation of a feed into four products (D, S1, S2, and B) of desired purity. In Figure 3a, the column subsections are numbered for easy reference; sections 1 and 2 constitute the prefractionator while sections 3–7 constitute the main column.

In Figure 3b, we show a photograph of the experimental column.¹⁵ The height of the column is 8 m, and it operates under atmospheric pressure. The column subsections are packed with 6-mm glass Raschig rings. The column sections have packed sections with temperature probes, and their locations are shown in Figure 3c.

The reboiler is of the kettle type, and its power is controlled by voltage to the heater elements through a thyristor. The water-cooled condenser is mounted on top of the column. The condensate returns to the column due to gravity; a part is taken out as top product and the rest forms the liquid reflux. The control setup is implemented in LabView on a standard PC.

The liquid reflux split valve R_{L1} and the valves for the products, D, S1, and S2, R_{L2} , R_{L3} , and R_{L4} , respectively, are all swinging funnels. These are controlled by externally placed solenoids. Since these are ON/OFF valves, a continuous output of the proportional–integral (PI) controller is implemented using pulse width modulation.

The two vapor split valves are made of stainless steel and are operated by externally placed electrical motors using rack and pinion assembly. Figure 4a shows a schematic of the valves. There are two such valves, one below section 2 and one below section 6 (denoted V1 and V2 in Figure 3a), but they should be operated such that one of them is always fully open. The vapor flow rate through the valve is manipulated by opening and closing a cap that sits on a steel valve seat. There is a liquid downcomer which is needed to allow the liquid to flow against the pressure drop over the valve. The downcomer is designed to ensure that the vapor passes only through the clearance between the cap and the seat.

The circular pinion of each valve is powered by a step motor. The full span of the valve is divided into 150 small steps. In the current setting, the free cross section in the valve is somewhat too large, which results in very small required movements. As will be shown in the section Experiments, the valve can affect the flows only in the first 10 steps. While the performance of the valve could be significantly improved, having such a poor resolution

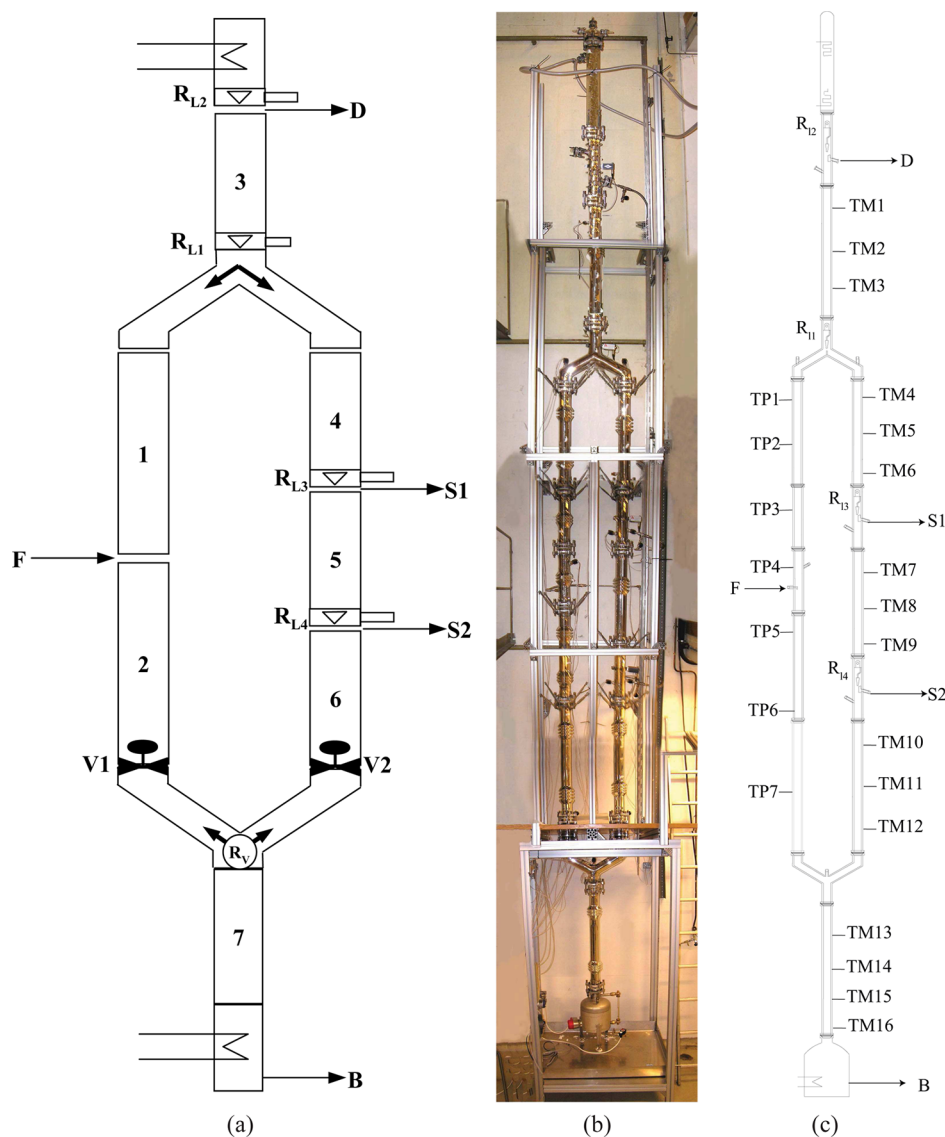

Figure 3. (a) Schematic of four-product Kaibel column with adjustable vapor split ratio (R_v). (b) Photograph of the experimental column.¹⁵ (c) Location of temperature sensors.¹⁵

provides an excellent case for demonstrating the effect of feedback, which we document below.

EXPERIMENTS

Vapor Split Valve Behavior. The first experiment was designed to test the behavior of the vapor split valves. This was done under total reflux conditions (no feed or products) and with constant liquid split (R_{L1}) using only two chemical components, namely, methanol and ethanol. After charging the reboiler, the heating was started with a fixed duty of 1.9 kW.

After reaching steady state operation, step changes were made to vapor valve V1 while valve V2 was fully open. The results are shown in Figure 5, where we show the effect of these changes on one prefractionator temperature ($T_2 \equiv TP5$) and one main column temperature ($T_5 \equiv TM7$). Any change in the vapor flow rate resulting from changes by the vapor split valve should lead to changes in these two temperatures. The output of the liquid split valve is manually fixed during this run.

When we close valve V1 from 15 steps to 10 steps at around 3 min, temperature T_2 starts gradually decreasing while T_5 starts increasing. This indicates, as expected, that less vapor is being

sent to the prefractionator, while more vapor is being directed to section 6. At around 7 min, V1 is further closed by 5 steps. This gives a more noticeable change in the vapor flows and is clearly indicated by about 1 K drop in T_2 and about 0.6 K temperature increase in T_5 . This change is reversed when valve V1 is opened from 5 steps to 15 steps at about 13 min. A series of changes between 10 steps and 15 steps shows insignificant changes in the two temperatures. At around 33 min, V1 is closed from 8 steps to 3 steps. This leads to sharp changes in temperatures T_2 and T_5 . At 37 min, valve V1 is opened from 3 steps to 50 steps. Since the vapor dynamics are very fast, the initial response on the temperatures is very quick, but the steady state is restored more slowly.

We can conclude from this experiment that only the first 10 steps of the 150 steps are really effective, so the resolution is poor and the valve opening is too large. Nevertheless, we will see that the valve is acceptable for control purposes.

Total Reflux Experiments. To study the suitability of the valve for feedback control, we performed a set of experiments under total reflux conditions using only two components, namely methanol and ethanol, with a fixed duty of 1.9 kW.

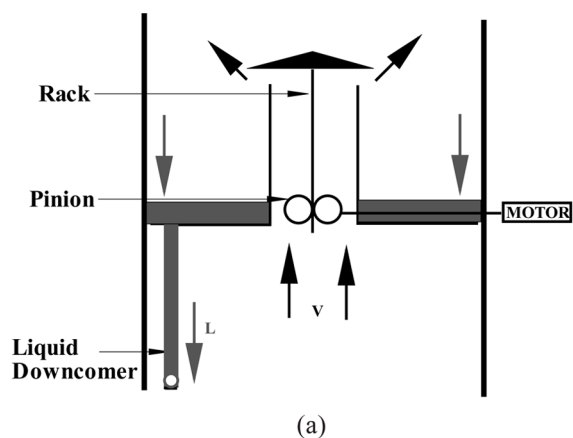

(a)



(b)

Figure 4. (a) Schematic and (b) photograph of the two vapor split valves.¹⁵

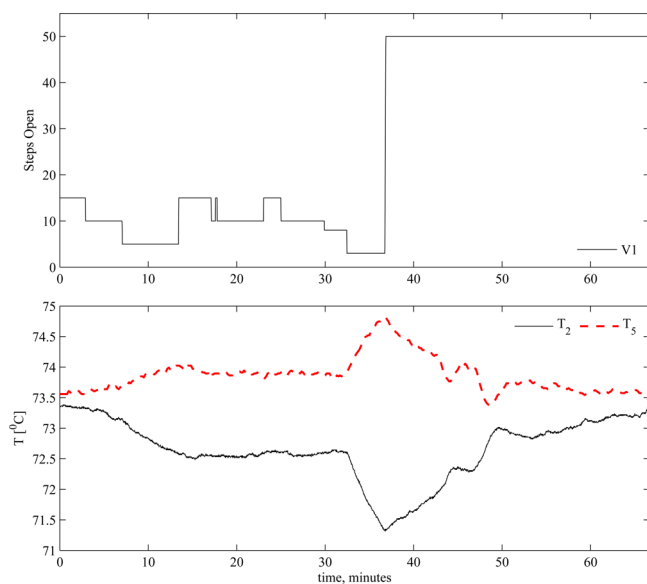

Figure 5. Experimental run: effect of changing the prefractionator vapor split valve V1 with valve V2 fully open on prefractionator (T_2) and main column (T_5) temperatures.

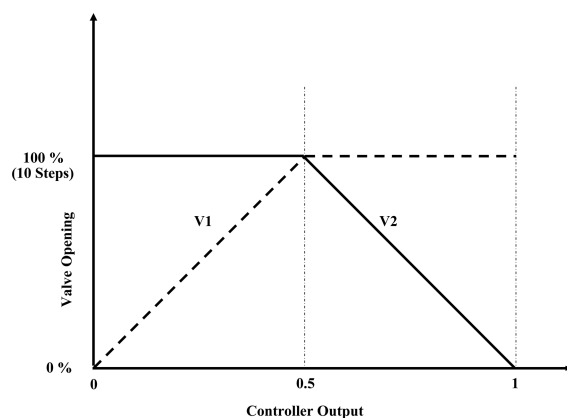

Figure 6. Split range logic (SRC) used for the vapor split controller.

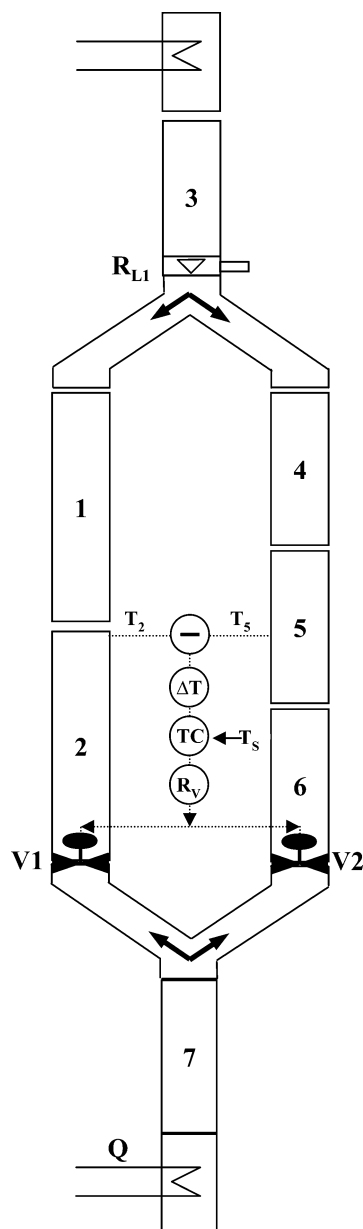

Figure 7. Control structure used for total reflux experiments. Vapor split (R_v) is used to control the temperature difference between sections 2 and 5 ($\Delta T = T_2 - T_5$; $T_2 \equiv TP5$ and $T_5 \equiv TM8$ in Figure 3c).

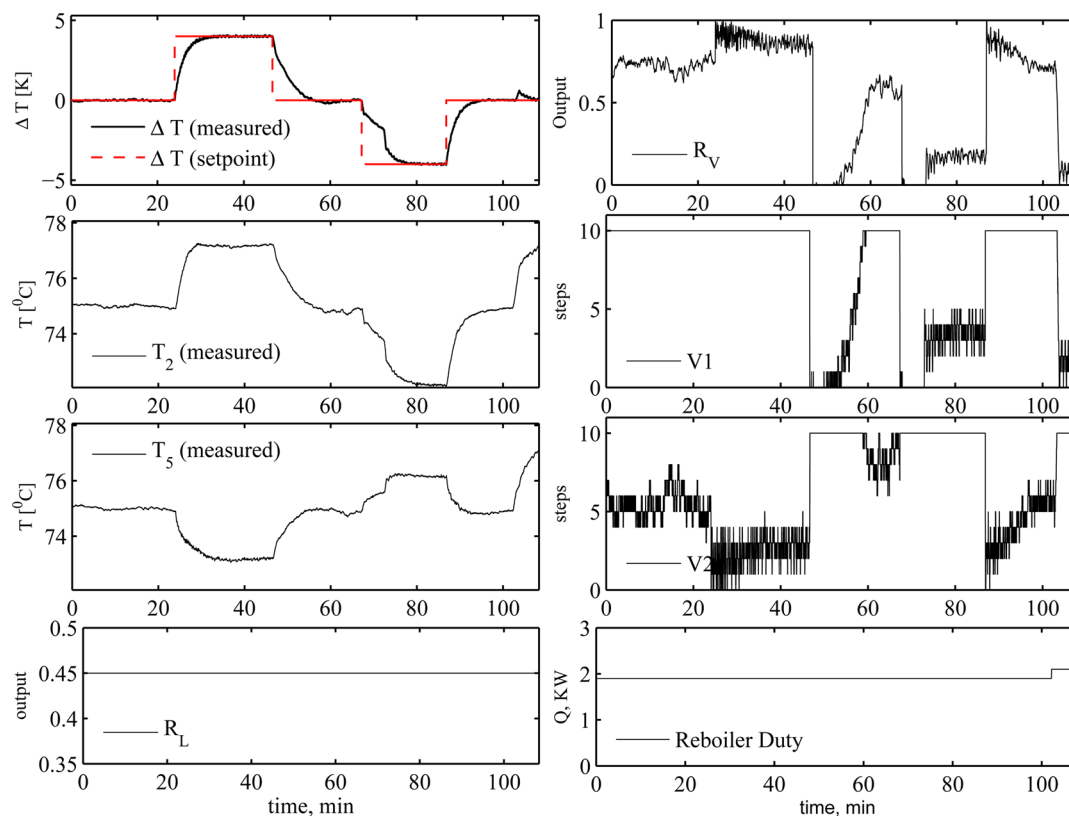

Figure 8. Initial experimental run 1: total reflux operation. Vapor split (R_V) is used to control ΔT across the wall.

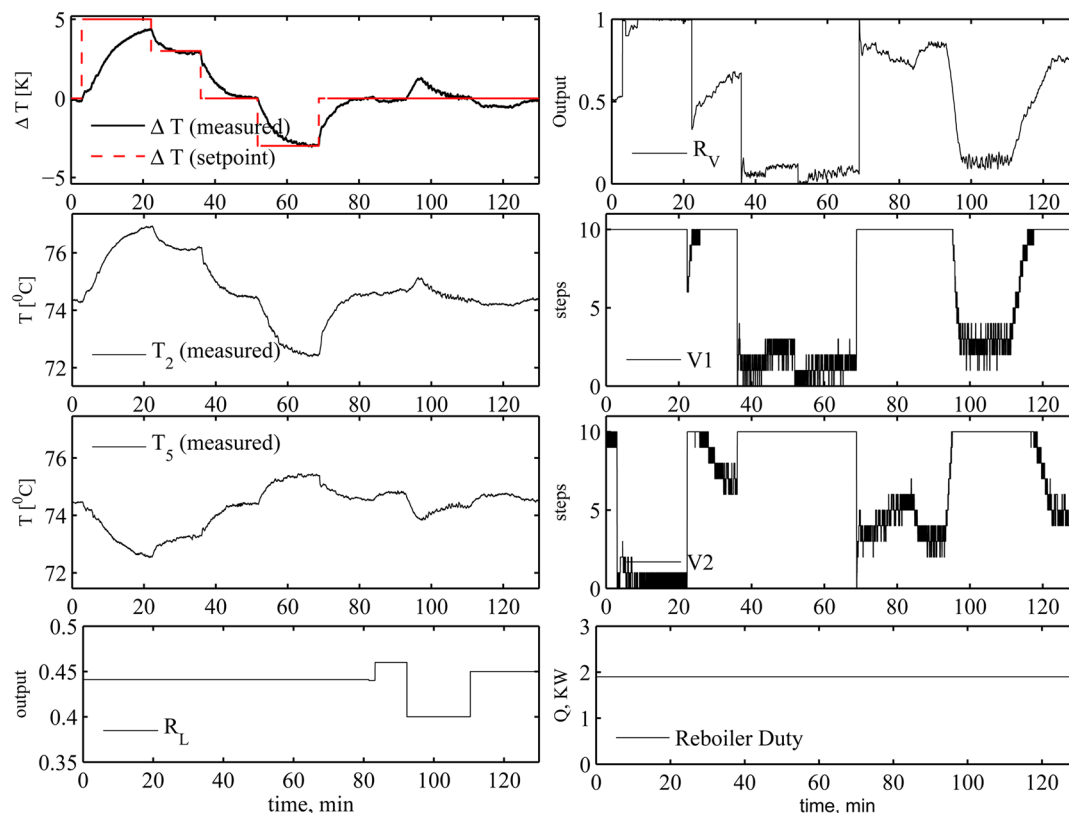

Figure 9. Initial experimental run 2: total reflux operation.

To minimize pressure drop, one of the valves should always be open. To ensure this, the valves are controlled using a split range

logic as shown in Figure 6. For a controller output of 0, valve V1 is closed and valve V2 is fully open, while for a controller output

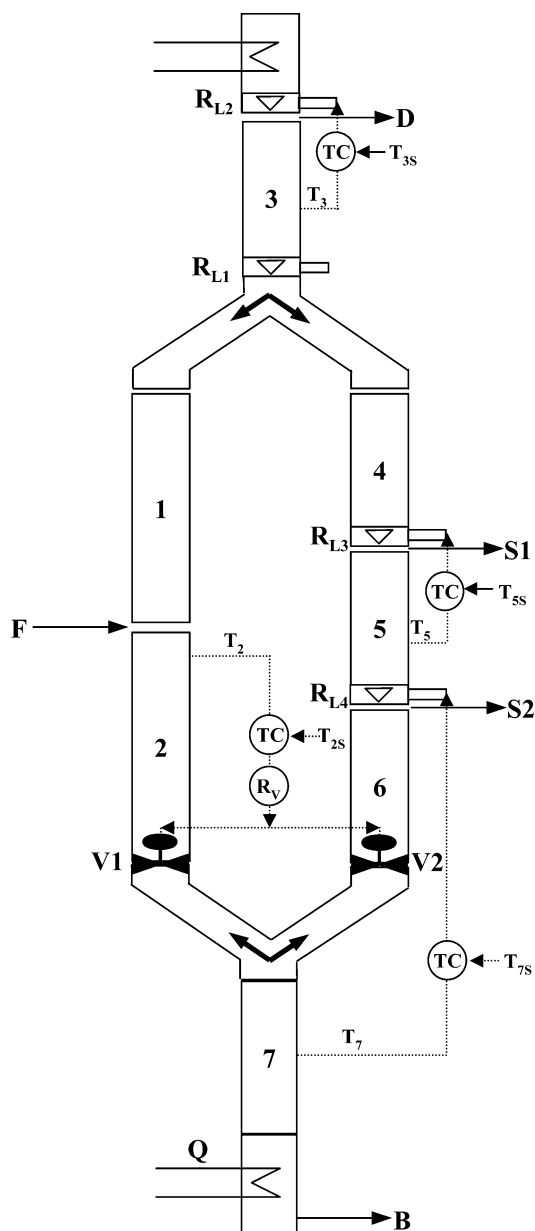

Figure 10. Four-point temperature control structure for continuous operation of Kaibel column using active vapor split (R_V) for control of prefractionator temperature (R_{L1} is kept constant, but could have been used for control, for example, of a temperature in top section of prefractionator).

of 0.5, both valves are fully open. Notice that we assume that 10 steps corresponds to a fully open valve.

The vapor split valves are used to control the temperature difference between the prefractionator and the main column, $\Delta T = T_2 - T_5$, as shown in Figure 7. The proportional–integral (PI) controller is tuned using the SIMC rules¹⁶ with the tuning parameter selected to be $\tau_c = 2$ min.

Figure 8 shows a series of set-point changes for ΔT . We plot the controlled variable (ΔT) and the controller output (R_V in the range 0–1), which through the split range logic changes the valves (V1 and V2). Figure 8 also shows the two individual temperatures (T_2 and T_5), the two valve opening step values (V1 and V2), and the values for the liquid split ratio (R_L) and reboiler duty (Q). Note that at any time at least one of the valves V1 or V2 is fully open.

For first 20 min the set point is unchanged at 0 K and the temperatures are steady. At 23 min, the set point for ΔT is increased to 4 K, which requires an increase in the vapor flow to the prefractionator. This set point is reached in about 7 min without any overshoots. This is followed by a series of set-point changes which can be tracked as well. At about 100 min, a disturbance is introduced by increasing the reboiler duty by 0.2 kW. This is shown by an increased difference in temperature by about 0.6 K. However, the controller can bring the controlled variable back to the set point of 0 K. In summary, we see from Figure 8 that the vapor split valves are fully acceptable for closed-loop operation.

Figure 9 shows another experiment under more difficult conditions. With a large set-point change for ΔT of +5 K at about 3 min, the output of the controller saturates and the set point cannot be reached. The reason is probably that valve V2 is nearly fully closed. However, when the set point is reduced, it can be reached. During the last 30 min of the run, we also give disturbances by changing the output of the liquid split valve between 0.4 and 0.46. These disturbances can also be handled by the vapor split valve.

On the basis of these experiments, we conclude that even rough manipulation of the vapor flow yields good temperature control when implemented in an appropriate feedback loop.

Four-Product Kaibel Column experiments. The following experiment demonstrates that the vapor split also can be used in practice for continuous operation. Strandberg and Skogestad¹⁷ found in a simulation study that a four-point temperature control scheme with one temperature controlled in the prefractionator can stabilize the column and as well as prevent “drift” of the composition profiles during operation. Correspondingly, in our previous experimental work,¹⁸ we used the liquid split (R_{L1}) to control a temperature in a prefractionator (with a constant vapor split R_V).

Here, we show that the temperature in the prefractionator can be controlled equally well using the vapor split (R_V) (with a constant liquid split, R_{L1}). Figure 10 shows the control structure where a sensitive temperature in prefractionator section 2 (T_2) is controlled using the vapor split valve. In addition, one temperature in each of sections 3, 5, and 7 are controlled by the distillate split valve (R_{L2}), upper side product split valve (R_{L3}), and lower side product split valve (R_{L4}), respectively. The details of the loop pairing are given in Table 1. The additional degree of freedom, i.e., the liquid split, is not used in this stabilizing layer and is available for optimizing an objective such as to reduce energy for a required purity specification.

An experimental run is shown in Figure 11. At about 8 min, the set point for the temperature T_2 controlled by the vapor split valve (loop 1) is changed from 90 to 92 °C. This set-point change can be handled well, and the temperature settles in less than 5 min. The other temperature loops show some deviation due to interactions; however, all the temperatures are brought back to their set points in about 20 min.

There is a large scope for improving the vapor split valve and suggesting alternative designs. Nevertheless, even with our prototype valve with poor resolution, experimental results show that the vapor split can be manipulated effectively in feedback mode to achieve more energy efficient operation of dividing-wall columns.

DISCUSSION

Feedback Implementation of Vapor Split. We argue here in favor of feedback control using vapor split valves to set the

Table 1. Four-Point Temperature Regulatory Control Structure for Kaibel Column^{a,b,c,d}

control loop	manipulated variable	controlled variable
loop 1	vapor split valve (R_V)	temperature in section 2 (T_2)
loop 2	distillate split valve (R_{L2})	temperature in section 3 (T_3)
loop 3	upper side product split valve (R_{L3})	temperature in section 5 (T_5)
loop 4	lower side product split valve (R_{L4})	temperature in section 7 (T_7)

^aThe ratio R_{L1} is fixed and is not used in the control structure. ^bControlled variables are temperatures as shown in Figure 3c: $T_2 = TP5$, $T_3 = TM3$, $T_5 = TM8$, and $T_7 = TM14$. ^cDefinitions of swinging funnel ratios:

$$R_{L1} = \frac{L_1}{L_3}, R_{L2} = \frac{L_3}{L_3 + D}, R_{L3} = \frac{L_5}{L_5 + S1}, R_{L4} = \frac{L_6}{L_6 + S2}$$

where L_1 , L_3 , L_5 , and L_6 are liquid flows in sections 1, 3, 5, and 6, respectively. $S1$ and $S2$ are side product flow rates (see Figure 3). ^dVapor split valve ratio:

$$R_V = \frac{V_2}{V_7} = \frac{V_2}{V_2 + V_6}$$

where V_2 , V_6 , and V_7 are vapor flows in sections 2, 6, and 7, respectively (see Figure 3).

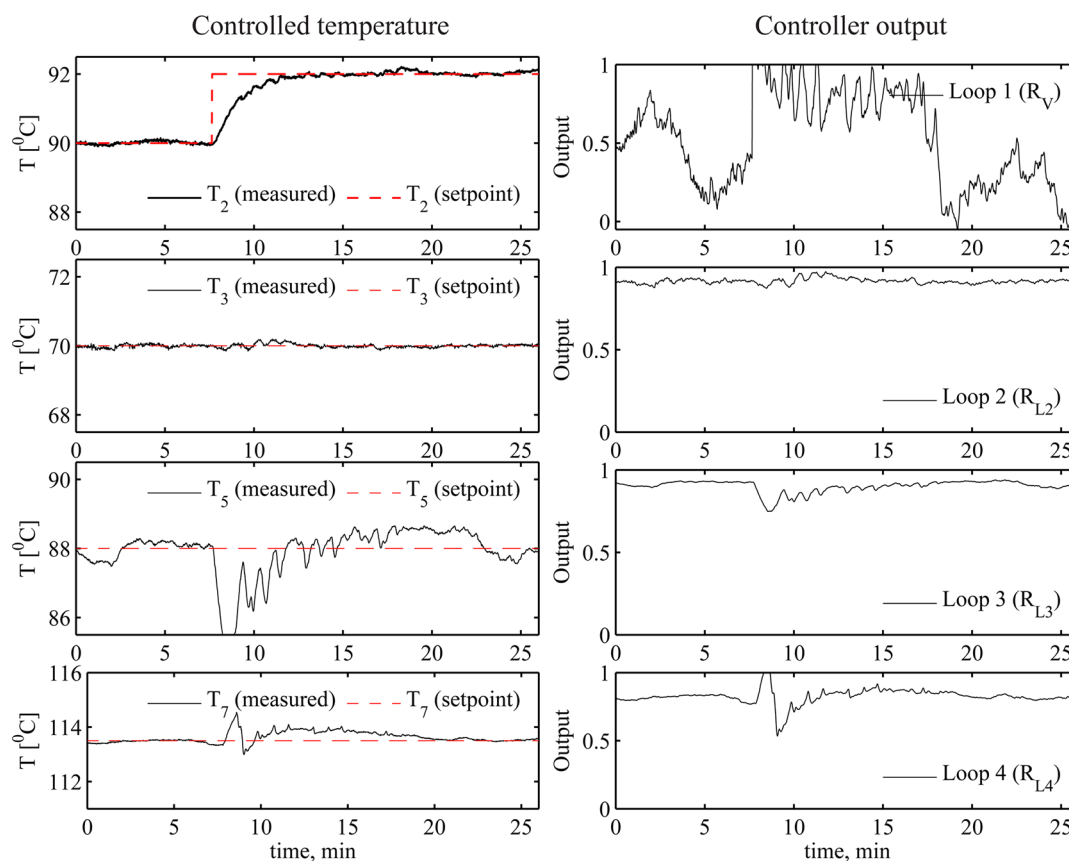

Figure 11. Main experimental run 3: continuous operation of Kaibel column using four-point temperature control with active vapor split (R_V).

“optimum vapor split” between the prefractionator and the main column in dividing-wall columns. There are two advantages for using the vapor split valve in the feedback loop. First, the vapor split valve is a very fast handle since the vapor dynamics are much faster than the liquid. Further, there is no need to precisely measure the vapor split; the feedback action can “drive” the vapor split to its optimum value by tracking some controlled variable such as a composition or a temperature (Figure 10).

The additional degree of freedom, i.e., the liquid split, which can be adjusted more easily manually, can be used to reduce the

energy usage for a required purity specification or to improve the purities for a given energy usage.

Finally, note that the vapor split remains as a degree of freedom when we introduce the feedback temperature controller, as it can be set to any value by adjusting the temperature set point.

Use of Two Vapor Valves. In this work, two vapor valves are used to implement the active vapor split control. The use of two valves is needed to get the full range of changes in the vapor split. Another advantage of using two vapor valves is that, for a given vapor split ratio, there may be several combinations of the

openings of the two vapor valves. Of all such combinations, the proposed solution shall offer a minimum pressure drop. This is because, with the split range logic shown in Figure 6, one of the valves is always fully open while the other is operated (opening less than 100%). This is verified in the experimental runs (see Figures 8 and 9).

CONCLUSIONS

The experimental results show for the first time that the vapor split can be used as a degree of freedom during practical operation of integrated columns, such as Petlyuk, Kaibel, and dividing-wall columns. Only with the vapor split available as a degree of freedom can the optimal operation be achieved. In particular, a vapor split valve was found to be useful for closed-loop temperature or composition control, where deficiencies and inaccuracy in the vapor valves are corrected for by use of feedback as shown in Figures 8, 9, and 11. The vapor split, which is difficult to set freely because of deficiency in the valve, is translated to a set point for temperature or composition, which is then a degree of freedom and can be set freely. The vapor split valve used in this study is clearly not optimally designed, but results with an improved valve may not be very different, because temperature control is already satisfactory.

AUTHOR INFORMATION

Corresponding Author

*E-mail: skoge@ntnu.no.

Present Address

§Senior Process Engineer, Aker Solutions, Stavanger, Norway.

Notes

The authors declare no competing financial interest.

ACKNOWLEDGMENTS

Mr. Jon Anta Buljo Hansen, Master Student (Cybernetics), Norwegian University of Science and Technology, assisted with the modifications of the column and LabView implementation.

REFERENCES

- (1) Petlyuk, F.; Platonov, V.; Slavinskii, D. Thermodynamically optimal method for separating multicomponent mixtures. *Int. Chem. Eng.* **1965**, *5*, 555–561.
- (2) Kaibel, G. Distillation columns with vertical partitions. *Chem. Eng. Technol.* **1987**, *10*, 92–98.
- (3) Halvorsen, I. J.; Skogestad, S. Minimum Energy Consumption in Multicomponent Distillation. 2. Three-Product Petlyuk Arrangements. *Ind. Eng. Chem. Res.* **2003**, *42*, 605–615.
- (4) Dejanovic, I.; Matijasevic, L.; Olujic, Z. Dividing wall column—A breakthrough towards sustainable distilling. *Chem. Eng. Process.: Process Intensif.* **2010**, *49*, 559–580.
- (5) Niggemann, G.; Hiller, C.; Fieg, G. Experimental and Theoretical Studies of a Dividing-Wall Column Used for the Recovery of High-Purity Products. *Ind. Eng. Chem. Res.* **2010**, *49*, 6566–6577.
- (6) Mutalib, M. I. A.; Zeglam, A. O.; Smith, R. Operation and Control of Dividing Wall Distillation Columns: Part 2: Simulation and Pilot Plant Studies Using Temperature Control. *Chem. Eng. Res. Des.* **1998**, *76*, 319–334.
- (7) Mutalib, M. I. A.; Smith, R. Operation and Control of Dividing Wall Distillation Columns: Part 1: Degrees of Freedom and Dynamic Simulation. *Chem. Eng. Res. Des.* **1998**, *76*, 308–318.
- (8) Kiss, A. A.; Bildea, C. S. A control perspective on PI in dividing-wall columns. *Chem. Eng. Process.: Process Intensif.* **2011**, *50*, 281–292.
- (9) Ling, H.; Cai, Z.; Wu, H.; Wang, J.; Shen, B. Remixing Control for Divided-Wall Columns. *Ind. Eng. Chem. Res.* **2011**, *50*, 12694–12705.
- (10) Rewagad, R. R.; Kiss, A. A. Dynamic optimization of a dividing-wall column using model predictive control. *Chem. Eng. Sc.* **2012**, *68*, 132–142.
- (11) Ling, H.; Luyben, W. L. Temperature Control of the BTX Divided-Wall Column. *Ind. Eng. Chem. Res.* **2010**, *49*, 189–203.
- (12) Agrawal, R.; Fidkowski, Z. T. More operable arrangements of fully thermally coupled distillation columns. *AIChE J.* **1998**, *44*, 2565–2568.
- (13) Halvorsen, I. J.; Skogestad, S. Optimal operation of Petlyuk distillation: steady-state behavior. *J. Process Control* **1999**, *9*, 407–424.
- (14) Ghadrddan, M.; Halvorsen, I. J.; Skogestad, S. Optimal operation of Kaibel distillation columns. *Chem. Eng. Res. Des.* **2011**, *89*, 1382–1391.
- (15) Strandberg, J. Optimal Operation of Dividing Wall Columns. Ph.D. Thesis, Department of Chemical Engineering, Norwegian University of Science and Technology, Trondheim, Norway, 2011.
- (16) Skogestad, S. Simple analytic rules for model reduction and PID controller tuning. *J. Process Control* **2003**, *13*, 291–309.
- (17) Strandberg, J.; Skogestad, S. *Proceedings of ADCHEM 2006, Gramado, Brazil*; IFAC: Laxenburg, Austria, 2006; Vol. 2, pp 623–628.
- (18) Dwivedi, D.; Halvorsen, I.; Skogestad, S. Control Structure Design for Optimal Operation of Thermally Coupled Columns. Presented at the AIChE Spring Meeting, 2011; 107f.