

**CONTROLLABILITY ANALYSIS
AND
PLANTWIDE CONTROL**

Sigurd Skogestad
Norwegian University of Science and Technology
N-7034 Trondheim, Norway

Honeywell IAC Phoenix at Union Hills, 21 Nov. 1997

Controllability analysis and plantwide control

- "What makes a plant difficult to control"
- "What to measure, what to manipulate and how to interconnect"

Some ideas and insights are presented on these topics, which up to now have largely been based on engineering experience and intuition.

References

1. Book by S. Skogestad and I. Postlethwaite, "Multivariable feedback control" (Wiley, 1996)
 - Chapter 5. LIMITATIONS ON PERFORMANCE IN SISO SYSTEMS
 - Chapter 6. LIMITATIONS ON PERFORMANCE IN MIMO SYSTEMS
 - Chapter 10. CONTROL STRUCTURE DESIGN
2. S. Skogestad, "A procedure for SISO controllability analysis" *Comp.Chem.Engng.*, **Vol. 20**, 373-386, 1996.
3. S. Skogestad, "Design modifications for improved controllability - with application to design of buffer tanks", Paper 222e, AIChE Annual Meeting, San Francisco, Nov. 13-18, 1994. (available in postscript-file:
<http://www.chembio.ntnu.no/users/skoge/publications/1994/sisosf.ps>
4. J. Morud and S. Skogestad, "Dynamic behaviour of integrated plants", *J. Process Control*, **6**, 145-146, 1996.

OUTLINE:

- Why feedback
- Example: Effect of uncertainty and cascade control
- Controllability
 1. Scaling
 2. Disturbances
 3. Input constraints
- Application: pH - neutralization process
- Multivariable systems
- Distillation control
- Plantwide control and dynamics

Notation

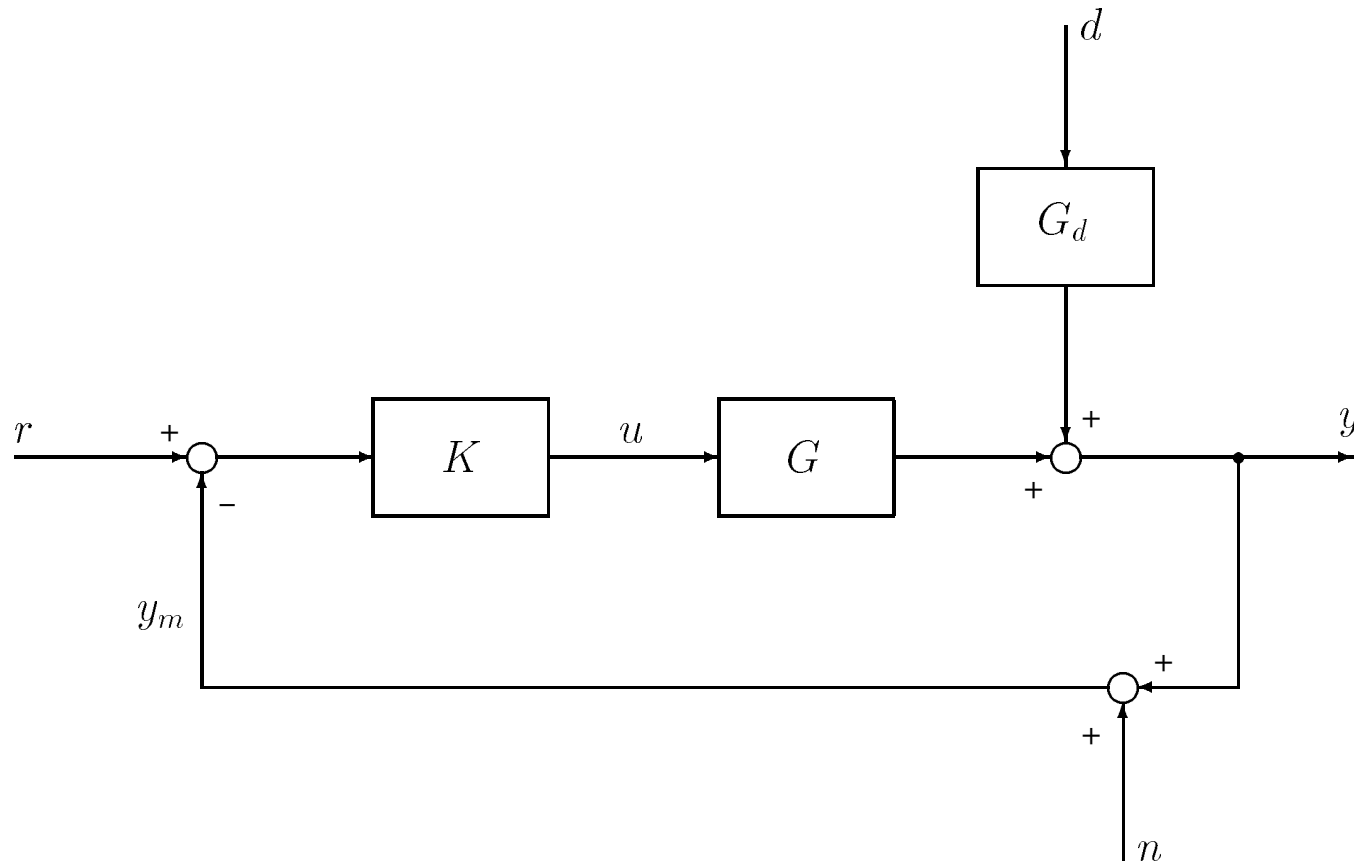

- u - plant inputs (manipulated variables)
- d - disturbance variables
- y - plant outputs (controlled variables)
- r - reference values (setpoint) for plant outputs

Process models in deviation variables

$$y = G(s)u + G_d(s)d$$

- G - effect of change in plant inputs on outputs
- G_d - effect of disturbances on outputs

Feedback control

$$u = K(s)(r \ominus y)$$

Closed-loop response

$$y = \underbrace{(I + GK)^{-1}}_S G_d d + \underbrace{GK(I + GK)^{-1}}_T r$$

- S - sensitivity function
- $T = I \ominus S$ - complementary sensitivity function

THE SENSITIVITY FUNCTION

Control error with no control (“open-loop”, $u = 0$)

$$e_o = y_o \Leftrightarrow r = G_d d \Leftrightarrow r$$

Control error with **feedback control** (“closed-loop”, $u = K(r \Leftrightarrow y)$)

$$e_c = y_c \Leftrightarrow r = SG_d d \Leftrightarrow Sr = Se_o$$

where the **sensitivity function** is

$$S = \frac{1}{1 + L}; \quad L = GK$$

\Rightarrow The effect of feedback is given by S .

- Sensitivity S is small (and control performance is good) at frequencies where the loop gain L is much larger than 1.
- Integral action yields $S = 0$ at steady-state
- Problem: Must have $|L| < 1$ at frequencies where phase shift through L exceeds $\Leftrightarrow 180^\circ$ (Bode’s stability condition).

Plot of typical L and S

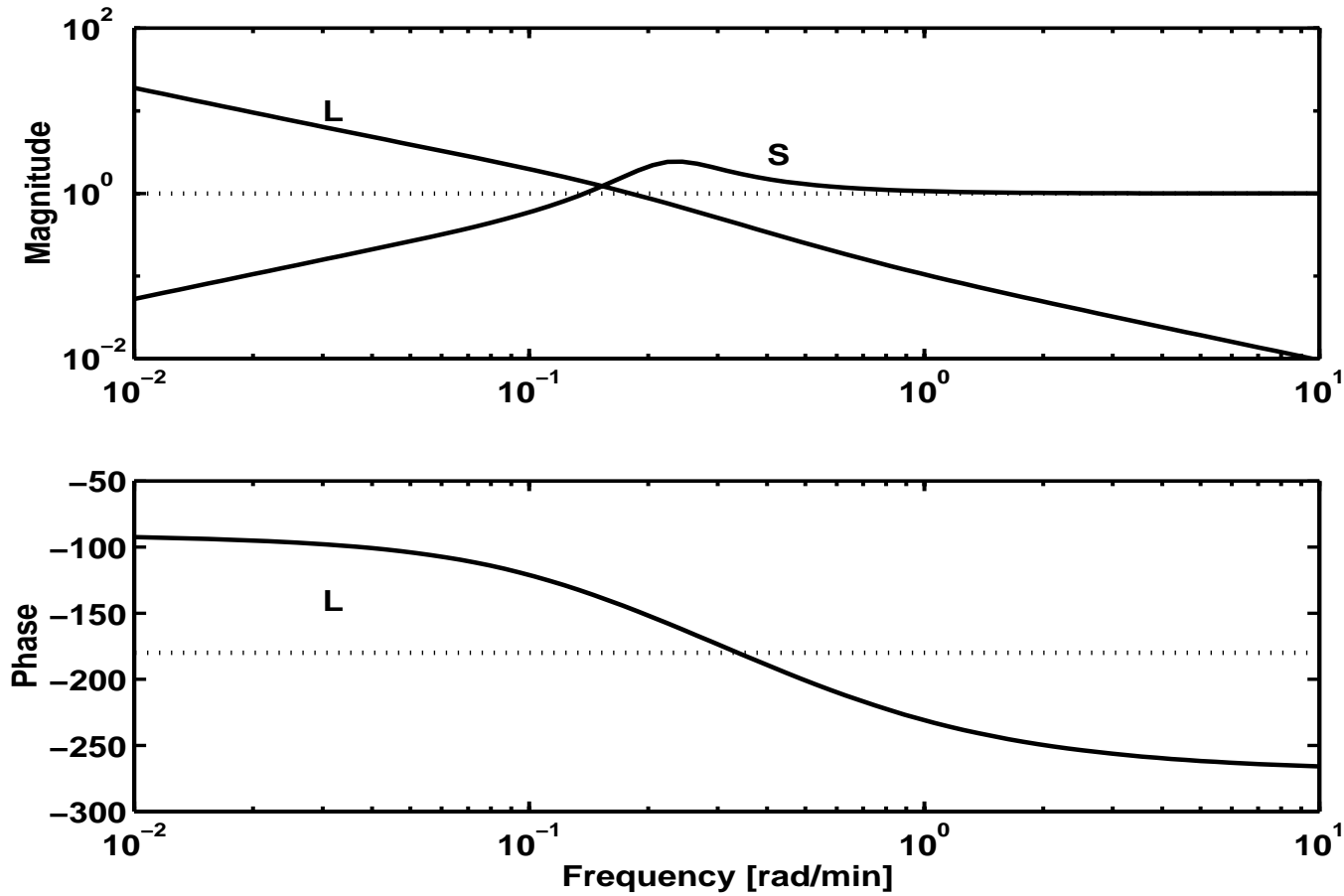

Bandwidth ω_B : Frequency up to which control is effective

Closed loop response time $\tau_c \approx 1/\omega_B$

- Low frequencies ($\omega < \omega_B$): $|S| < 1$. Feedback improves performance ($|S| < 1$)
- Intermediate frequencies (around ω_B): Peak with $|S| > 1$. Feedback degrades performance
- High frequencies ($\omega \gtrsim 5\omega_B$): $S \approx 1$. Feedback has no effect
- Generally: “Resonance” peak in $|S|$ around the bandwidth. For example, $|S| = \sqrt{2} = 1.4$ at the frequency where $|L| = 1$ if the phase margin is 45° .
- At high frequencies: Process lags make $|L| \rightarrow 0$ so $|S| \rightarrow 1$

WHY FEEDBACK CONTROL?

- Why use feedback rather than simply feedforward control?

Three fundamental reasons:

1. Stabilization. **Only** possible with feedback
 2. Unmeasured disturbances
 3. Model uncertainty (e.g. change in operating point)
- Feedback is most effective when used locally (because then response can be fast without inducing instability)

EXAMPLE: 3 TANKS IN SERIES

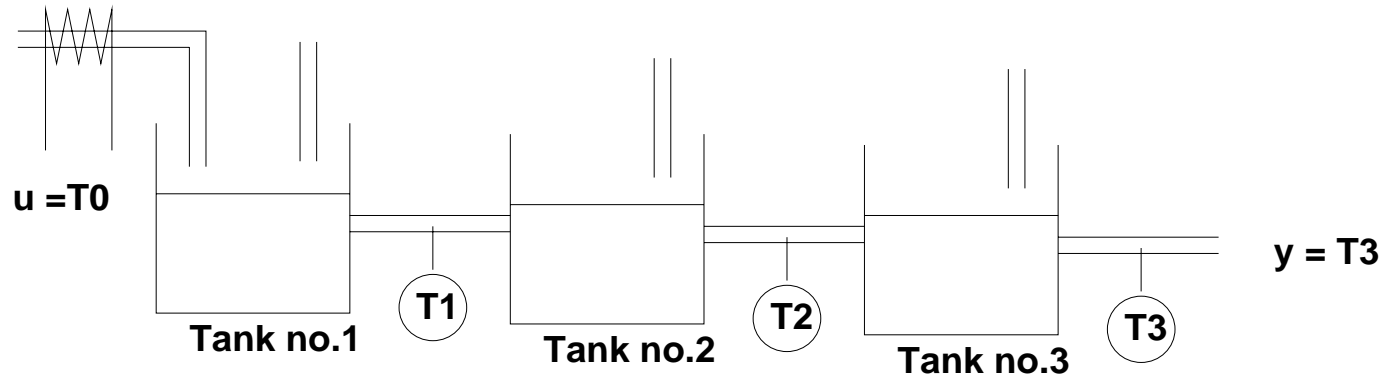

- $T_i = \frac{k_i}{\tau_i s + 1} T_{i-1}$
- Nominal gains are 0.8 and time constants 1, 2 and 3 min

$$G_1 = \frac{0.8}{1s + 1}, \quad G_2 = \frac{0.8}{2s + 1}, \quad G_3 = \frac{0.8}{3s + 1}$$

- Overall. Gain = $0.8 \cdot 0.8 \cdot 0.8 = 0.51 = 1/1.95$

$$T_3 = G(s)T_0; \quad G(s) = \frac{0.51}{(1s + 1)(2s + 1)(3s + 1)}$$

- Task: Manipulate T_0 such that T_3 increases by 1 degree with a response time $\tau_c = 2.5$ min.

Control strategies:

1. Feedforward control (steady-state): $\Delta T_0 = 1.95$ (step)
2. Feedforward control (ideal with dynamics)
3. One feedback controller
 - A** Ideal high-order controller
 - B** PI-controller
4. Three cascaded feedback controllers

Will look at:

I Nominal operating point

II Change in operating point (larger gains)

1. Steady-state feedforward control

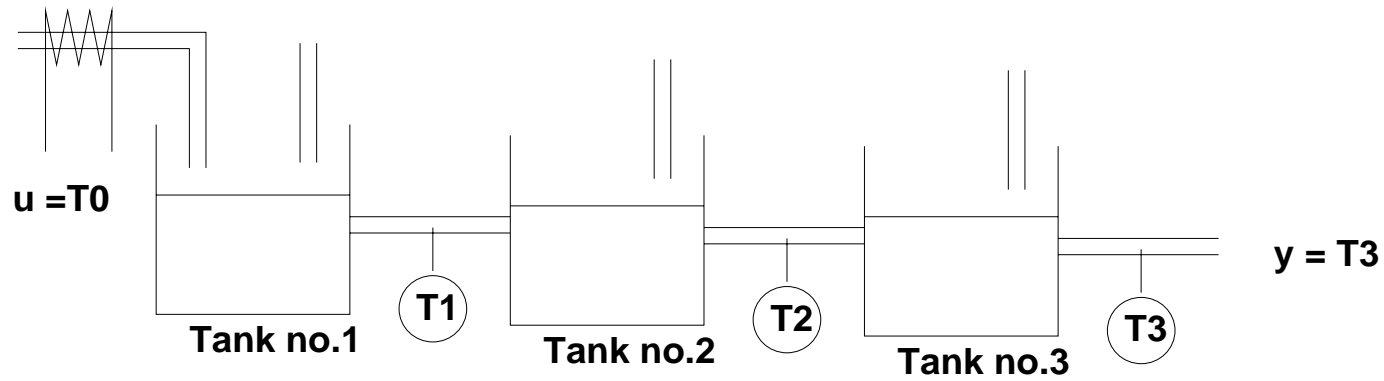

Make step change in T_0 of 1.95° .

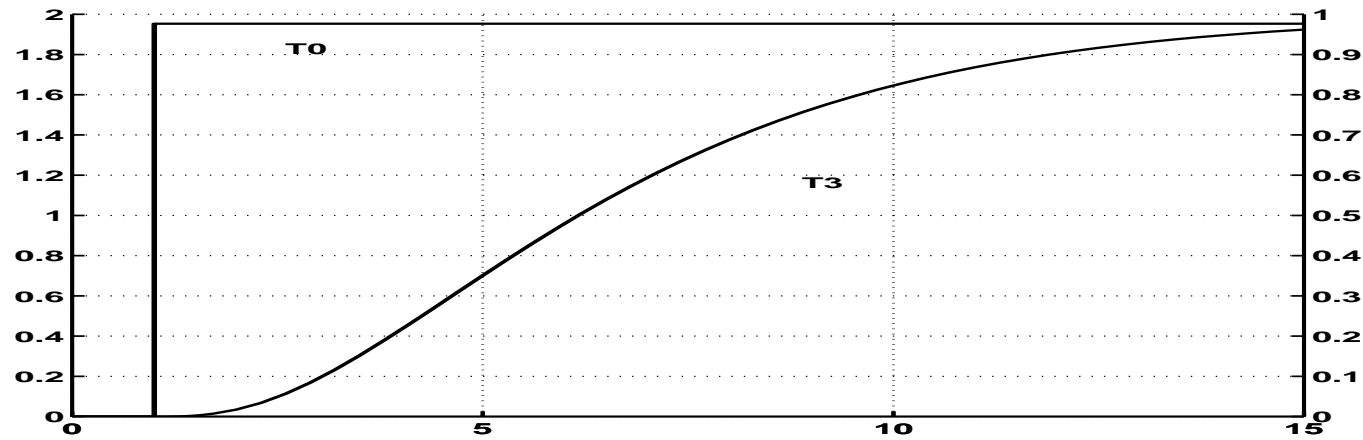

A factor 3 times too slow

2. Ideal feedforward control (with dynamics)

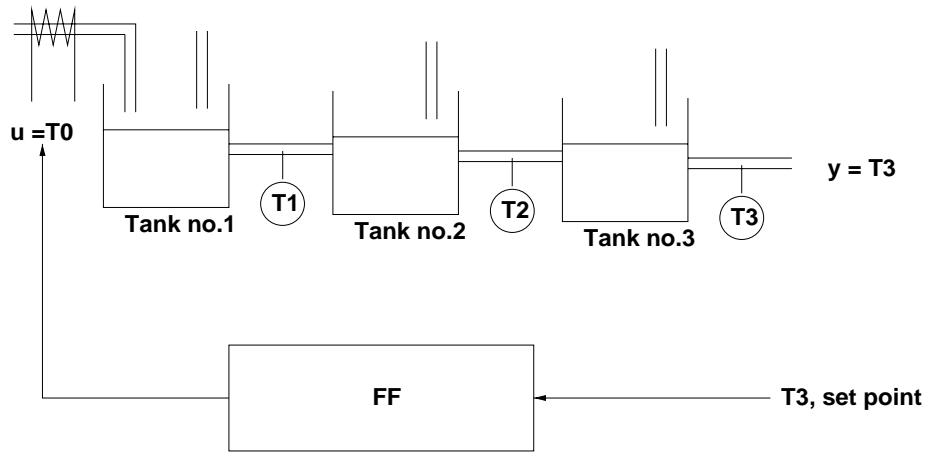

$$K_{ff}(s) = G^{-1}(s)f(s) = 1.95 \frac{(3s + 1)(2s + 1)(s + 1)}{s^3 + 2s^2 + 2s + 1}$$

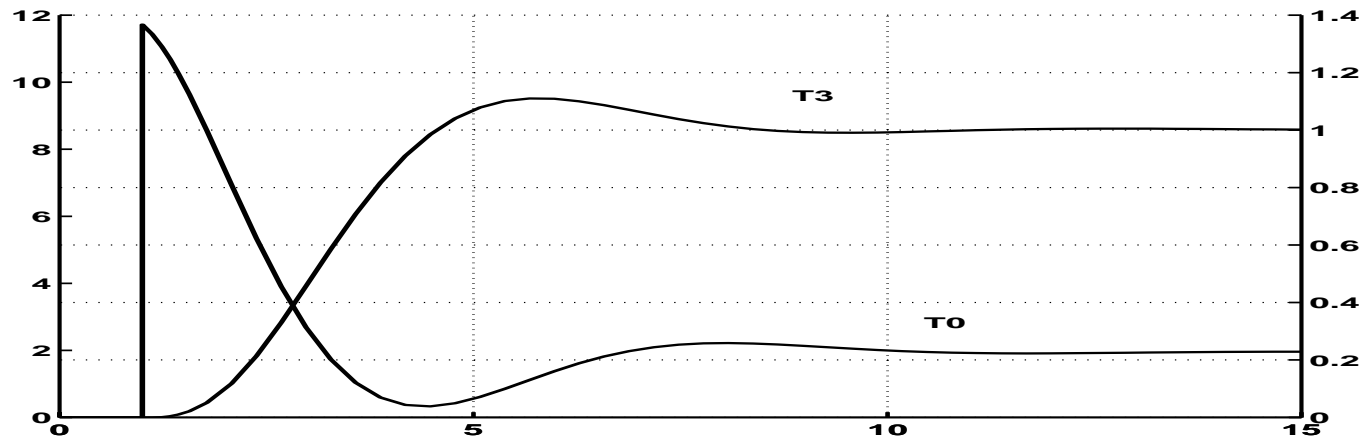

3A. “Ideal” feedback controller

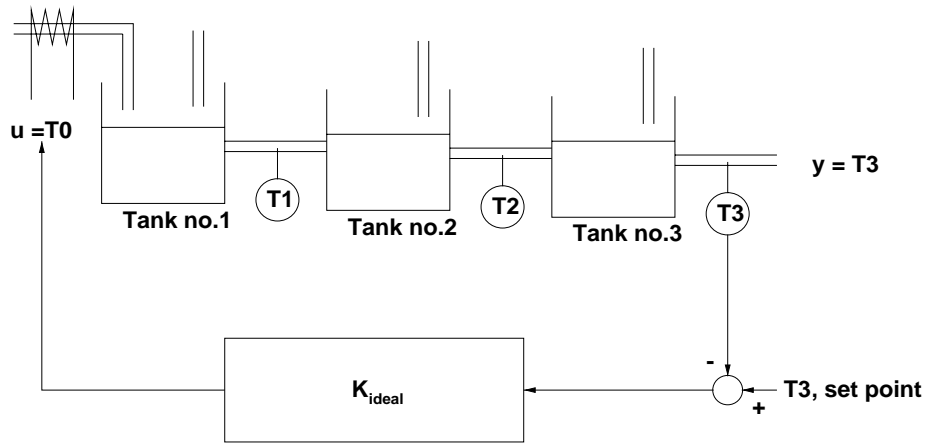

Third-order controller from Direct synthesis = IMC tuning ($\tau_c = 2$):

$$K(s) = \frac{1.95}{\tau_c s} \frac{(3s + 1)(2s + 1)(s + 1)}{0.5s^2 + s + 1}$$

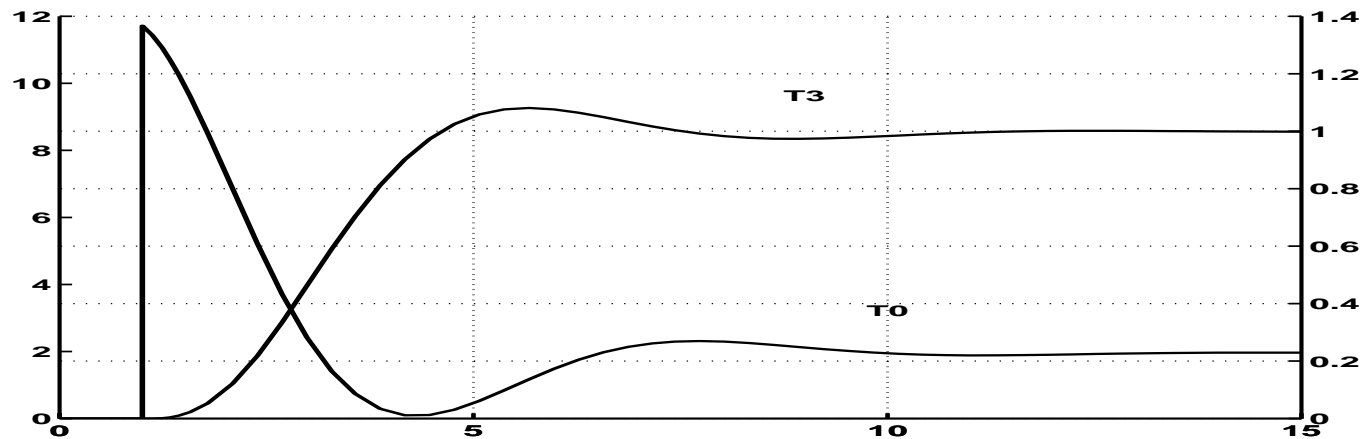

3B. PI feedback controller

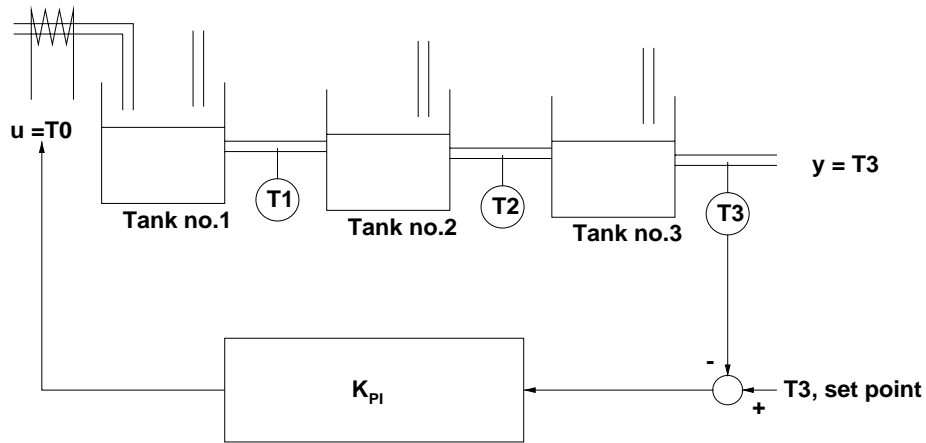

$$K(s) = 2.25 \frac{4.5s + 1}{4.5s}$$

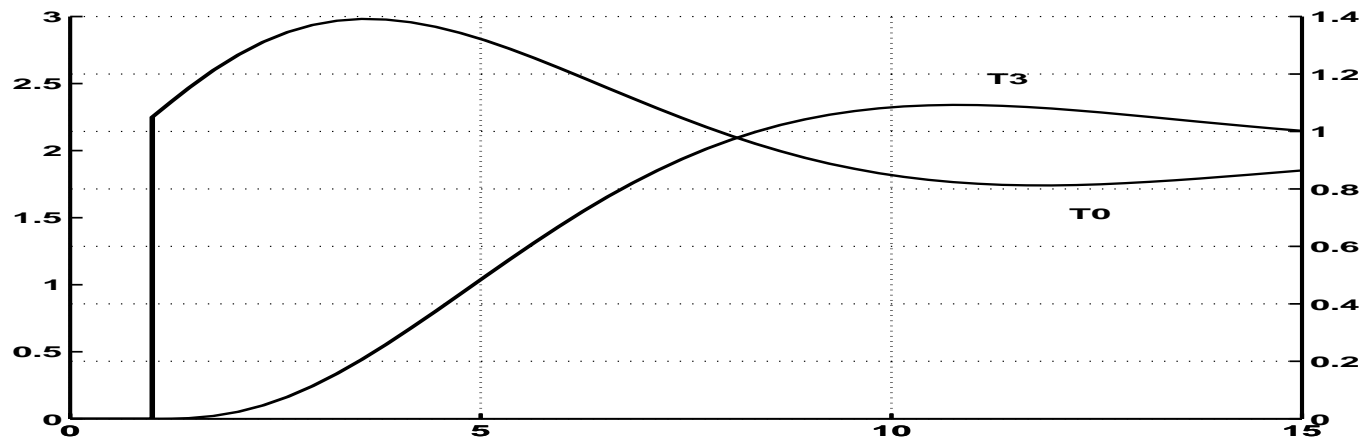

Too slow ! (gets unstable if much faster)

4. Three cascaded feedback controllers

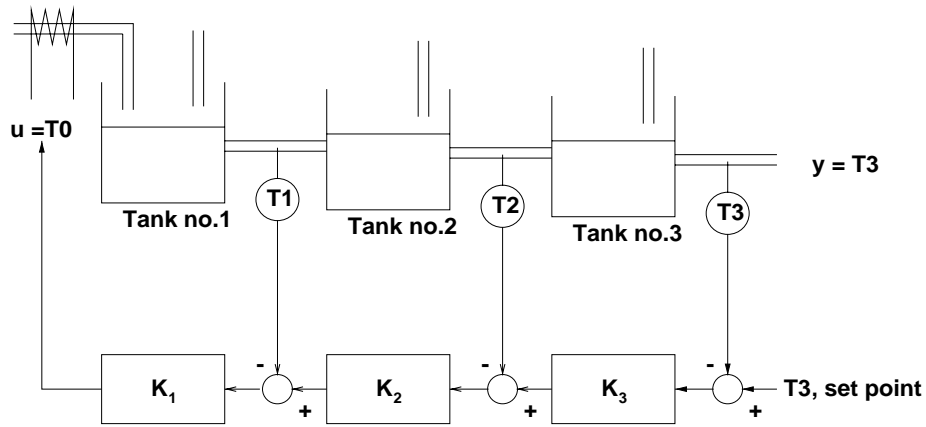

Two extra temperature measurements. Three PI controllers (direct synthesis):

$$K_i(s) = \frac{1}{\tau_{ci}s} \frac{\tau_i s + 1}{k_i}; \quad \tau_{c1} = 0.5; \tau_{c2} = 1; \tau_{c3} = 2 \quad [\text{min}]$$

Factor two difference in response times with inner loop fastest

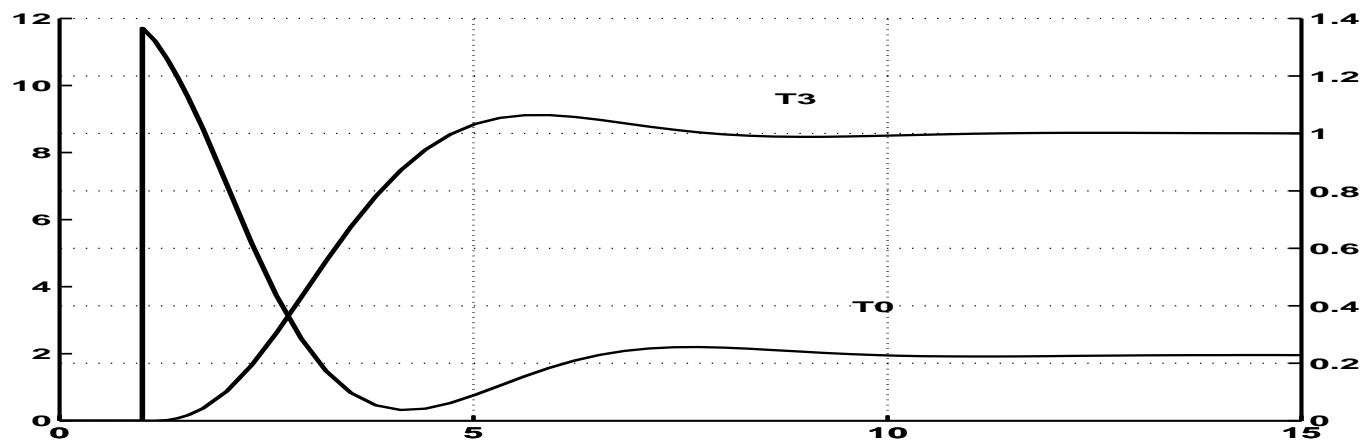

1. Steady-state feedforward control 2. Ideal feedforward control

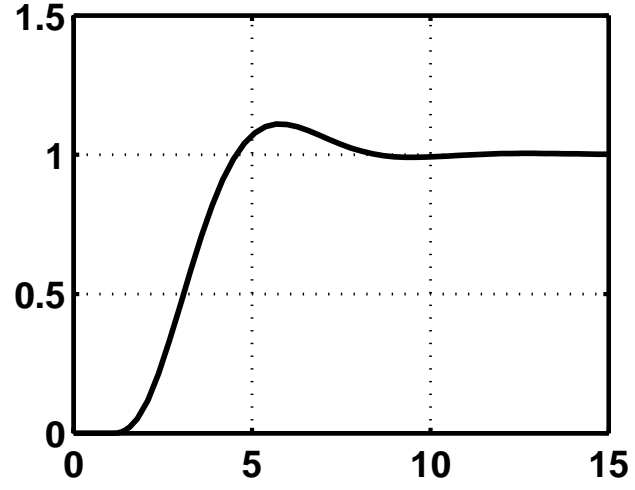
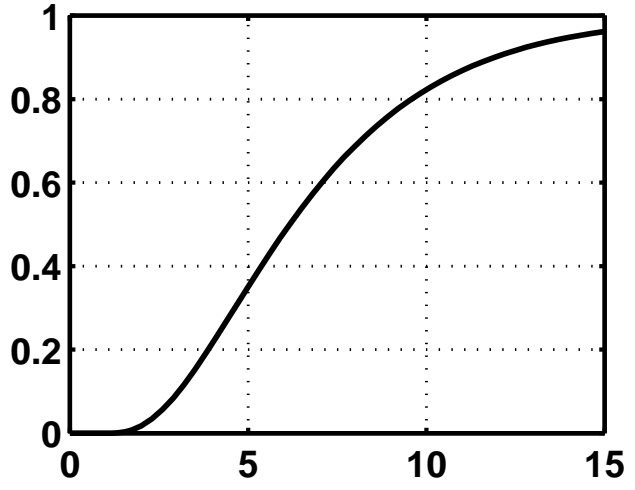

3. One "ideal" feedback controller 4. Three cascaded feedback

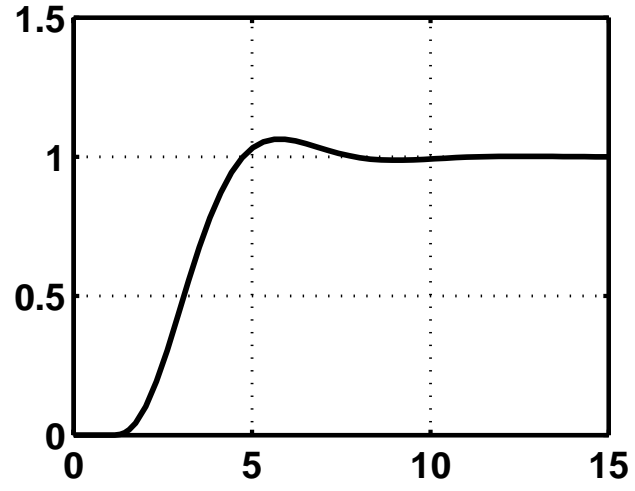
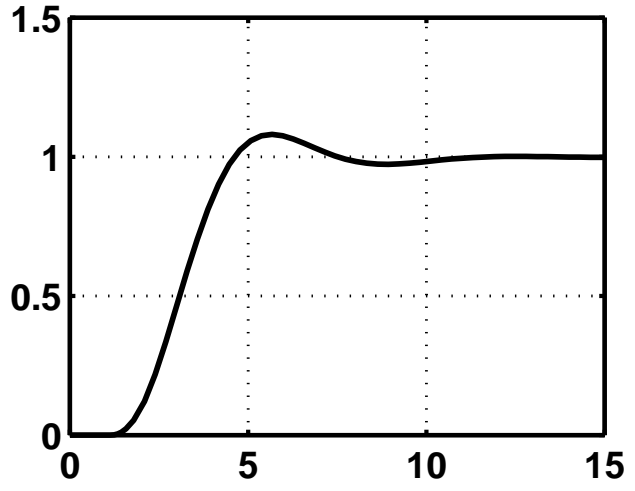

Conclusion: Nominal responses identical for cases 2, 3 & 4

Next: New operating point

10 to 40 % increase in gain and 20% decrease in time constant for each tank.

- Increase in plant gains

$$k'_1 = 0.8 \cdot 1.4 = 1.12; \quad k'_2 = 0.8 \cdot 1.2 = 0.96; \quad k'_3 = 0.8 \cdot 1.1 = 0.88$$

Overall gain is then increased from $0.8^3 = 0.51$ to

$$1.12 \cdot 0.96 \cdot 0.88 = 0.95$$

- All time constants decrease by 20% (e.g. τ_1 from 1 to 0.8 min)

1. Steady-state feedforward control

Temperature T_3 :

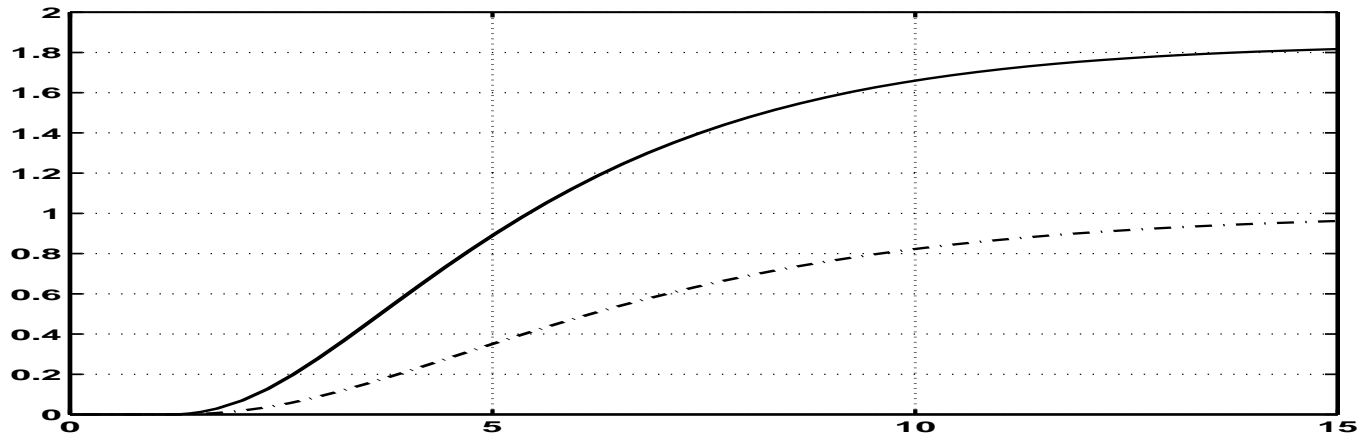

- Solid line: New operating point
- Dashed-dot line: Nominal operating point

Steady-state plant gain increases from 0.51 to 0.95 (increases by factor 1.85)

Feedforward control: 85% error at steady-state

No control (T_0 =constant): \Leftrightarrow 100% error

\Rightarrow Feedforward control may easily be worse than no control if there is enough gain uncertainty

2. Ideal feedforward control (with dynamics)

Temperature T_3 :

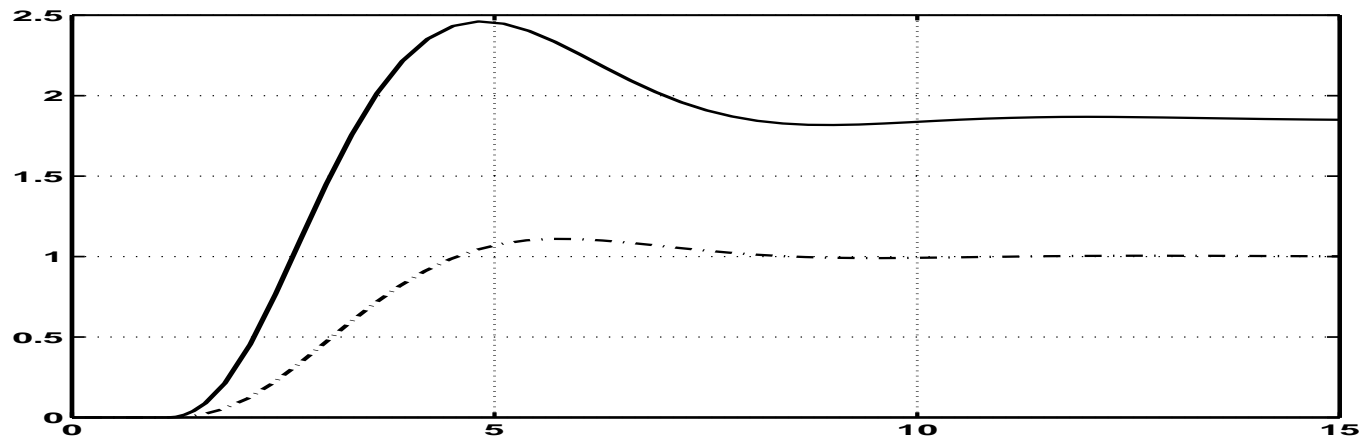

Main problem is still change in steady-state plant gain

3A. One “ideal” feedback controller

Temperature T_3 :

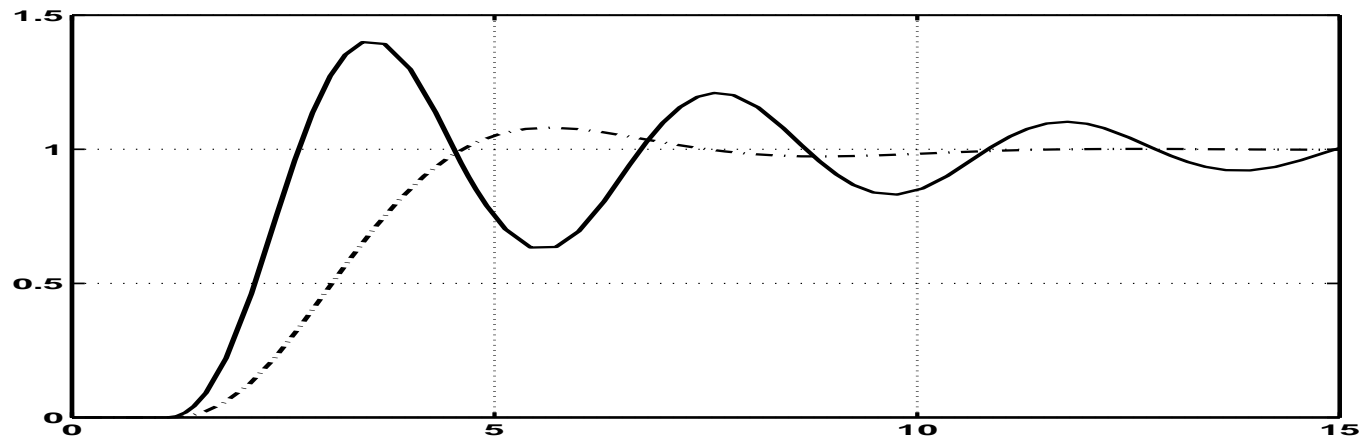

Feedback control reduces effect of uncertainty at steady-state

BUT: May get poor dynamic response

The response is unstable with small delay (0.2 min)

3B. PI feedback controller

Temperature T_3 :

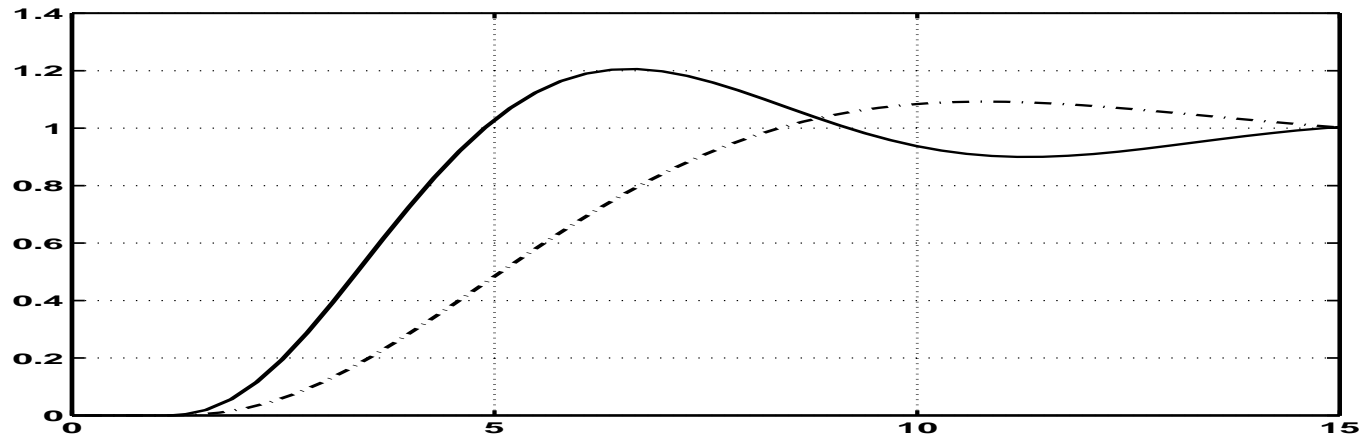

Quite sensitive to changes

Gets faster because gains have increased

4. Three cascaded feedback controllers

Temperature T_3 :

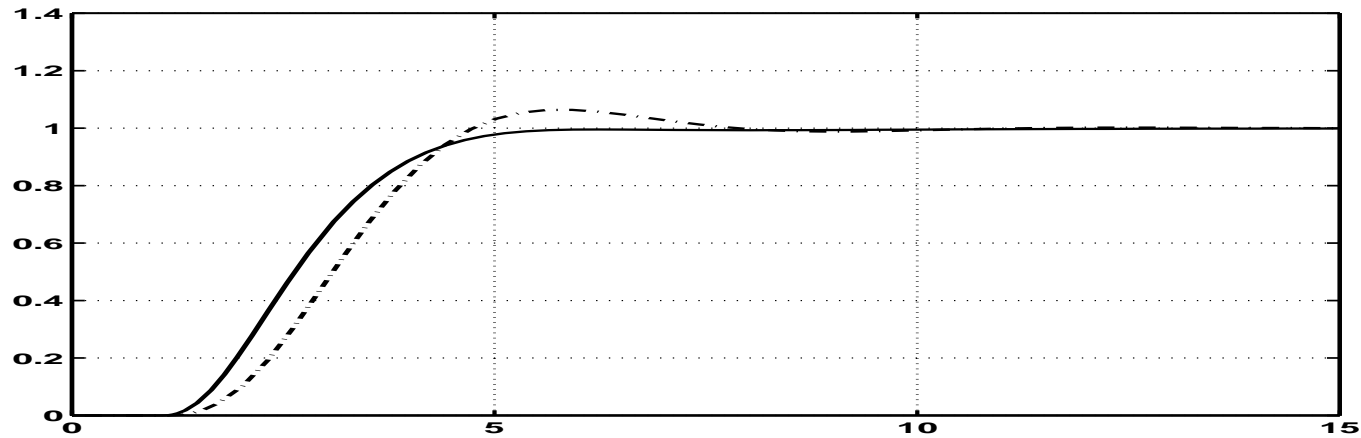

Almost unaffected by the change in operating point.

Fast inner loop takes care of the 40% gain change

Summary: Responses for T_3 at new operating point

1. Steady-state feedforward

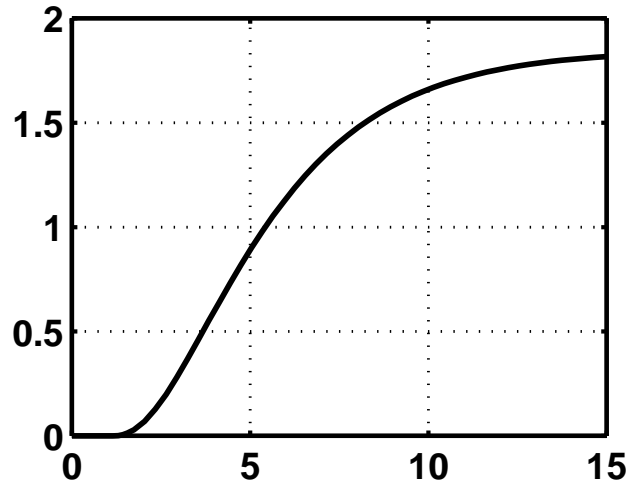

2. Ideal Feedforward control

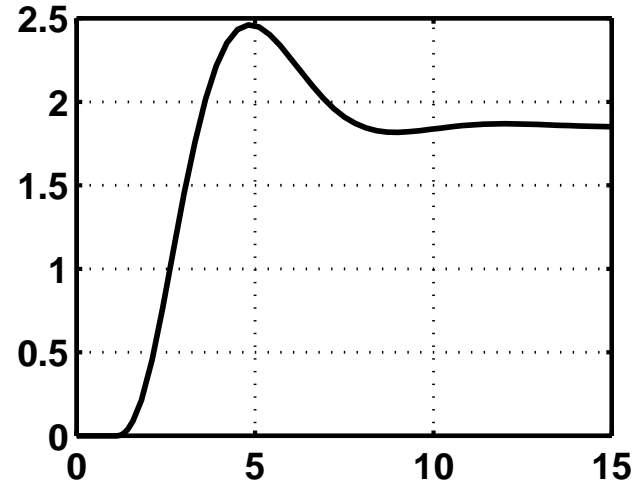

3A. Ideal feedback controller

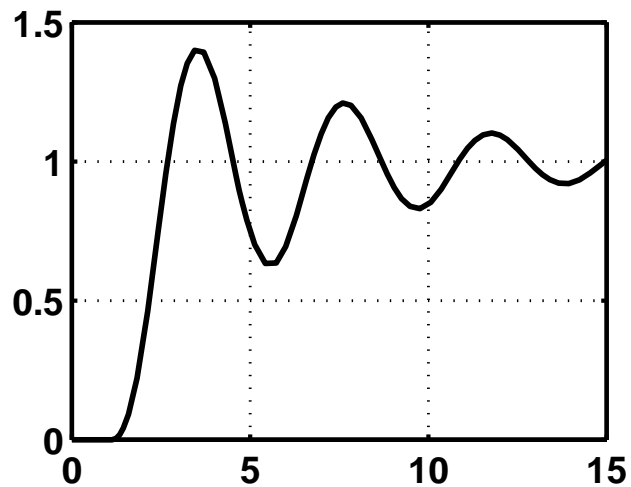

4. Cascade controllers

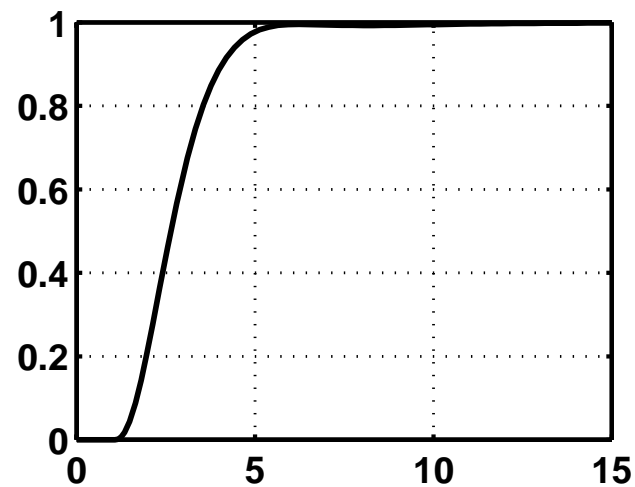

No longer identical!

CONCLUSION FROM EXAMPLE

- **Feedback** is an efficient tool to reduce the effect of uncertainty (e.g. caused by changes in the operating point)
- For example, large gain variations are easily absorbed using cascade control with local feedback loops
- Also effective for counteracting local disturbances
- Note: An optimizing control strategy (e.g. model predictive control) does not give the benefit of cascade feedback unless it is somehow “told” that there is model error (or at least local acting disturbances).

EFFECT OF UNCERTAINTY.

Nominal plant model: $y = Gu$ Actual plant model (with model uncertainty)

$$y' = G'u = G(1 + E)u$$

where E is the relative model error

$$E = \frac{G' \Leftrightarrow G}{G} = \frac{G'}{G} \Leftrightarrow 1$$

Feedforward control

Ideal feedforward controller: $u = G^{-1}r \Rightarrow y = 0r$

Actual response: $e' = y' \Leftrightarrow r = G'u \Leftrightarrow r = G'G^{-1}r \Leftrightarrow r = Er$

20% model error \Rightarrow 20% control error

Feedback control

Actual closed-loop response: $e' = y' \Leftrightarrow r = S'r = \frac{1}{1+ET}Sr$

\Rightarrow Model error has (almost) no effect on control error at frequencies where $|S|$ is small (low freq).

Simple Example. First-order plant with PI-controller

$$G = \frac{0.8}{1s + 1}; \quad K = \frac{1}{0.1s} \frac{1s + 1}{0.8}$$

Actual plant with 50% larger gain and 50% smaller time constant

$$G' = \frac{1.2}{0.67s + 1}$$

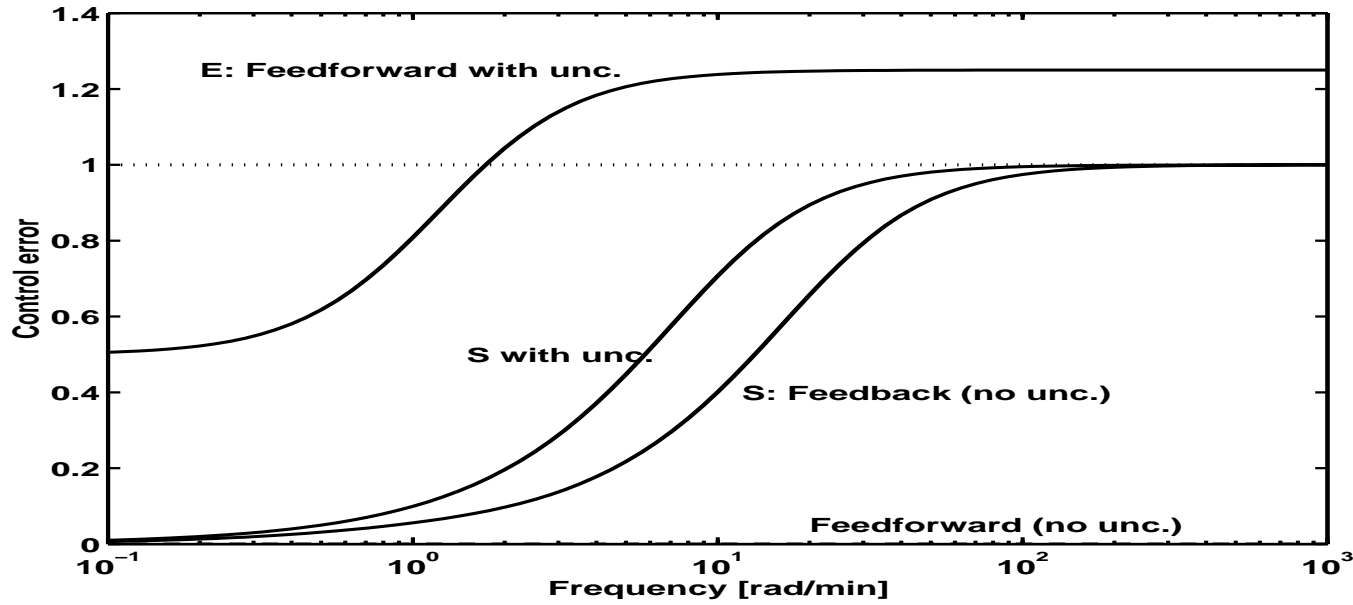

CONTROLLABILITY ANALYSIS

Before attempting controller design one should analyze the plant:

- Is it a difficult control problem?
- Does there exist a controller that meets the specs?
- How should the process be changed to improve control?

QUALITATIVE RULES from Seborg et al. (1989)

(chapter on “The art of process control”):

1. *Control outputs that are not self-regulating*
2. *Control outputs that have favorable dynamic and static characteristics, i.e., there should exist an input with a significant, direct and rapid effect.*
3. *Select inputs that have large effects on the outputs.*
4. *Select inputs that rapidly effect the controlled variables*

- Seems reasonable, but what is “self-regulating”, “large”, “rapid” and “direct” ?
- Objective: quantify !

DEFINITION

(INPUT-OUTPUT) CONTROLLABILITY =

The ability to achieve acceptable control performance.

More precisely: To keep the outputs (y) within specified bounds or displacements from their setpoints (r), in spite of unknown changes (e.g., disturbances (d) and plant changes) using available inputs (u) and available measurements (e.g., y_m or d_m).

- A plant is controllable if there **exists** a controller that yields acceptable performance.
- Thus, controllability is independent of the controller, and is a property of the plant (process) only.
- It can only be affected by changing the plant itself, that is, by **design modifications**.
 - measurement selection
 - actuator placement
 - control objectives
 - design changes, e.g., add buffer tank
- Surprisingly, methods for controllability analysis have been mostly qualitative.
- Most common: The “simulation approach” which requires a specific controller design and specific values of disturbances and setpoint changes.
BUT: Is result a fundamental property of the plant or does it depends on these specific choices?
- Here: Present quantitative controllability measures to replace this **ad hoc** procedure.

Remarks on above definition of controllability.

- Agrees with ones intuitive feeling, and was aslo how the term was used originally in the control literature.
- Ziegler and Nichols (1943): “Ability of the process to achieve and maintain the desired equilibrium value”.
- Rosenbrock (1970): “In engineering practice, a system is called controllable if it possible to achieve the specified aims of control, whatever these may be”.
- NOT same as Kalman’s (1960) “state controllability” (which unfortunately is synonymous with “controllability” in the system theory community).
- “State controllability”: Ability to bring a system from a given initial state to a final state (with NO regard to the dynamic response between and after these two states).
- Rosenbrock (1970): “The chief point to be stressed is that controllability is an engineering terms with a wide connotation. To restrict its meaning to one particular type of controllability seems wrong, and leads to confusion.”
- “Dynamic resilience”: Introduced by Morari (1983) to avoid confusion with state controllability. BUT does not express relation to control.
- Therefore: Propose to use “input-output controllability” to distinguish from “state controllability”.

Previous work on controllability analysis.

- Ziegler and Nichols (1943): Delay, Disturbance sensitivity
- Rosenbrock (1966, 1970) : RHP zeros
- Morari (1983): "Perfect control", Input magnitudes
- Balchen and Mumme (1988) and others: Engineering rules

“PERFECT CONTROL” and plant inversion. (Morari, 1983)

$$y = G(s) u + G_d(s) d$$

Ideal feedforward control, $y = r$:

$$u = G^{-1} r \Leftrightarrow G^{-1} G_d d \quad (1)$$

Feedback control:

$$u = G^{-1} T r \Leftrightarrow G^{-1} T G_d d \quad (2)$$

For frequencies below the bandwidth ($\omega < \omega_B$) : $T \approx I$: Then (2) =(1).

Controllability is limited if G^{-1} cannot be realized:

- Delay (Inverse yields prediction)
- Inverse response = RHP-zero (Inverse yields instability)
- Input constraints (Inverse yields saturation)
- Uncertainty (Inverse not correct)

POOR CONTROLLABILITY CAN BE CAUSED BY:

1. Delay or inverse response in $G(s)$
2. or $G(s)$ is of “high order” (tanks-in-series) so that we have an “apparent delay”
3. Constraints in the plant inputs (a potential problem if the plant gain is small)
4. Large disturbance effects (which require “fast control” and/or large plant inputs to counteract)
5. Instability: Feedback with the active use of plant inputs is required. May be unable to react sufficiently fast if there is an effective delay in the loop. And: May have problems with input saturation if there is measurement noise or disturbances
6. With feedback: Delay/inverse response or infrequent or lacking measurement of y . May try
 - (a) Local feedback (cascade) based on another measurement, e.g. temperature
 - (b) Estimation of y from other measurements

7. Nonlinearity or large variations in the operating point which make linear control difficult. May try
 - (a) Local feedback (inner cascades)
 - (b) Nonlinear transformations of the inputs or outputs, e.g. $\ln y$
 - (c) Gain scheduling controllers (e.g. batch process)
 - (d) Nonlinear controller
8. MIMO RHP-zeros: May have internal couplings resulting in multivariable RHP-zeros \Rightarrow Fundamental problem in controlling some combination of outputs.
9. MIMO plant gain: May not be able to control all outputs independently (if the “worst case” plant gain $\underline{\sigma}(G)$ is small).
10. MIMO interactions: May have large RGA-elements (caused by strong two-way interactions between the outputs) which makes multivariable control difficult.
11. Feedforward control: Should be considered if feedback control is difficult (e.g. due to delays in the feedback loop or MIMO interactions) and an “early” measurement of the disturbance is possible.

Would like to quantify this!

Example: First-order with delay process

$$g(s) = k \frac{e^{-\theta s}}{1 + \tau s}; \quad G_d(s) = k_d \frac{e^{-\theta_d s}}{1 + \tau_d s}$$

+ Measurement delays: θ_m, θ_{md} .

Problem: What values are desired for good controllability?

Qualitative results:

	Feedback control	Feedforward control
k	Large	Large
τ	Small	Small
θ	Small	Small
k_d	Small	Small
τ_d	Large	Large
θ_d	No effect	Large
θ_m	Small	No effect
θ_{md}	No effect	Small

- Response to maximum plant input ($u = 1$) is similar (but with k , τ and θ)

- Steady-state: Need $k > k_d$ to reject disturbance (otherwise inputs will saturate)
- Slopes of initial responses: Would like $k/\tau > k_d/\tau_d$ (to avoid input saturation)
- **Maximum response time with feedback:** Time from disturbance is detected on output until output exceeds allowed value of 1 $\approx \tau_d/k_d$
- **Minimum response time with feedback:** Sum delays around the loop = $\theta + \theta_m$
- **To counteract disturbance ($|y| < 1$) with feedback need:** $\theta + \theta_m < \tau_d/k_d$
- **Feedforward control.**

Time when $y = 1$: (“minimum reaction time”) $\approx \tau_d/k_d + \theta_d$ To counteract disturbance with feedforward control need:

$$\theta + \theta_{md} < \tau_d/k_d + \theta_d$$

Delay in disturbance model helps with feedforward.

Controllability analysis

- Step response analysis is difficult to generalize.

Open-loop analysis which does not consider closed-loop stability.

For example, consider disturbance with $k_d \gg 1$:

- Difficult disturbance: $G_{d1}(s) = k_d e^{-\theta_d s}$
 - Easy disturbance: $G_{d2}(s) = k_d / (1 + \frac{\theta_d}{n} s)^n$
 - BUT step response almost identical for n large
- Use frequency-domain analysis instead
 - Look at the sinusoidal disturbance response for one frequency at a time
 - Use Bode magnitude plots

Consider persistent sinusoids.

Assume that G and G_d are scaled such that all signals have magnitude less than 1 at each frequency:

$d = \pm 1$: Largest expected disturbance

$u = \pm 1$: Largest allowed input (e.g., constraint)

$e = \pm 1$: Largest allowed control error

$r = \pm R_{max}$: Largest expected reference change

Scaling procedure

Model in unscaled variables

$$y' = G'(s)u' + G'_d(s)d'$$
$$e' = y' \Leftrightarrow r'$$

Scaled variables: Normalize each variable by maximum allowed value

$$d = \frac{d'}{d_{max}}, u = \frac{u'}{u_{max}}, e = \frac{e'}{e_{max}}, y = \frac{y'}{e_{max}}, r = \frac{r'}{e_{max}}$$

where

- u_{max} - largest allowed change in u (saturation constraints)
- d_{max} - largest expected disturbance
- e_{max} - largest allowed control error for output
- r_{max} - largest expected change in setpoint

Note: e , y and r are in the same units: Must be normalized with the same factor (e_{max}). Let

$$R_{max} = \frac{r_{max}}{e_{max}}$$

R_{max} : Largest setpoint change relative to largest allowed control error. Most cases: $R_{max} \geq 1$.

With these scalings we have at all frequencies

$$|d(j\omega)| \leq 1, |u(j\omega)| \leq 1, |e(j\omega)| \leq 1, |r(j\omega)| \leq R_{max}$$

Scaled transfer functions

$$G(s) = G'(s) \frac{u_{max}}{e_{max}}; \quad G_d(s) = G'_d(s) \frac{d_{max}}{e_{max}}$$

Scaled model

$$y = G(s)u + G_d(s)d$$

$$e = y \Leftrightarrow r$$

CONTROLLABILITY RESULTS

1. Disturbances (speed of response)
2. Input constraints
3. Time delay
4. Inverse response - RHP zero
5. Phase lag
6. Instability
7. Summary

1. DISTURBANCES (speed of response)

Without control: $y = G_d d$

Worst-case disturbance: $|d| = 1$. Want $|y| < 1$

⇒ Need control at frequencies $\omega < \omega_d$ where $|G_d| > 1$.

⇒ Bandwidth requirement: $\omega_B > \omega_d$.

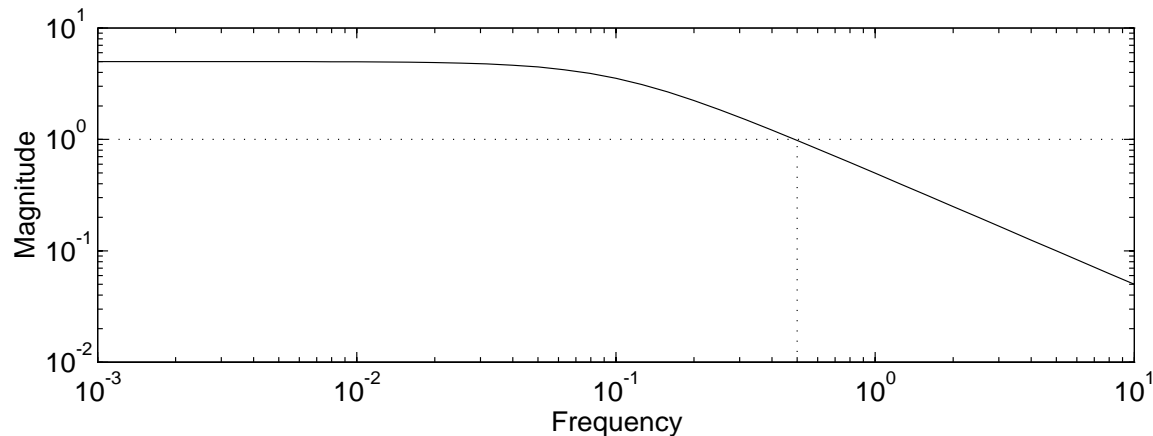

More specifically: With feedback control $y = SG_d d$ we must require $|SG_d(j\omega)| < 1$, or

$$|1 + L| > |G_d|$$

Thus, at frequencies where feedback is needed for disturbance rejection ($|G_d| > 1$), we want the loop gain $|L|$ to be larger than the disturbance transfer function, $|G_d|$ (appropriately scaled).

Example.

$$G_d(s) = \frac{k_d e^{-\theta_d s}}{1 + \tau_d s}; \quad k_d = 5, \tau_d = 10 \text{ [min]}$$

- $\omega_d \approx k_d/\tau_d = 0.5 \text{ rad/min} \Rightarrow \text{Min. response time 2 min}$).
- Waller et al. (1988): k_d/τ_d correlated well with observed disturbance sensitivity for distillation control.

REMARKS

Bandwidth

$$\omega_B > \omega_d = k_d/\tau_d$$

or equivalently in terms of the closed-loop response time

$$\tau_c < \tau_d/k_d$$

1. “Large disturbances (k_d large) with fast effect (τ_d small) requires fast control”.
2. Recall the following rule from Seborg *et al*:
 - “Control outputs that are not self-regulating”

This rule can be quantified as follows:

- Control outputs y for which $|G_d(j\omega)| > 1$ at some frequency.
3. NOTE: Delay in disturbance model has no effect on required bandwidth.
 4. BUT with feedforward control (measure disturbance): Delay makes control easier.
 5. Scaling critical for evaluating the effect of disturbances.

2. INPUT CONSTRAINTS

Process model

$$y = Gu + G_d d$$

1. Worst-case disturbance: $|d| = 1$. To achieve *perfect control* ($e = 0$) with $|u| < 1$ we must require

$$\boxed{|G| > |G_d|} \quad \text{at frequencies where } |G_d| > 1 \quad (3)$$

2. Worst-case reference: $|r| = R_{max}$. To achieve *perfect control* ($y = r$) with $|u| < 1$ we must require

$$\boxed{|G| > |R_{max}|} \quad \forall \omega \leq \omega_r \quad (4)$$

Remarks.

1. Recall the following rule from the introduction:

- “Select inputs that have large effects on the outputs.”

This rule may be quantified as follows:

- In terms of scaled variables: Need $|G| > |G_d|$ at frequencies where $|G_d| > 1$, and $|G| > R_{max}$ at frequencies where command following is desired.

2. Bounds (3) and (4) apply also to feedforward control.

3. For “acceptable” control ($|e| < 1$) we may relax the requirements to $|G| > |G_d| \Leftrightarrow 1$ and $|G| > |R_{max}| \Leftrightarrow 1$ but this has little practical significance.

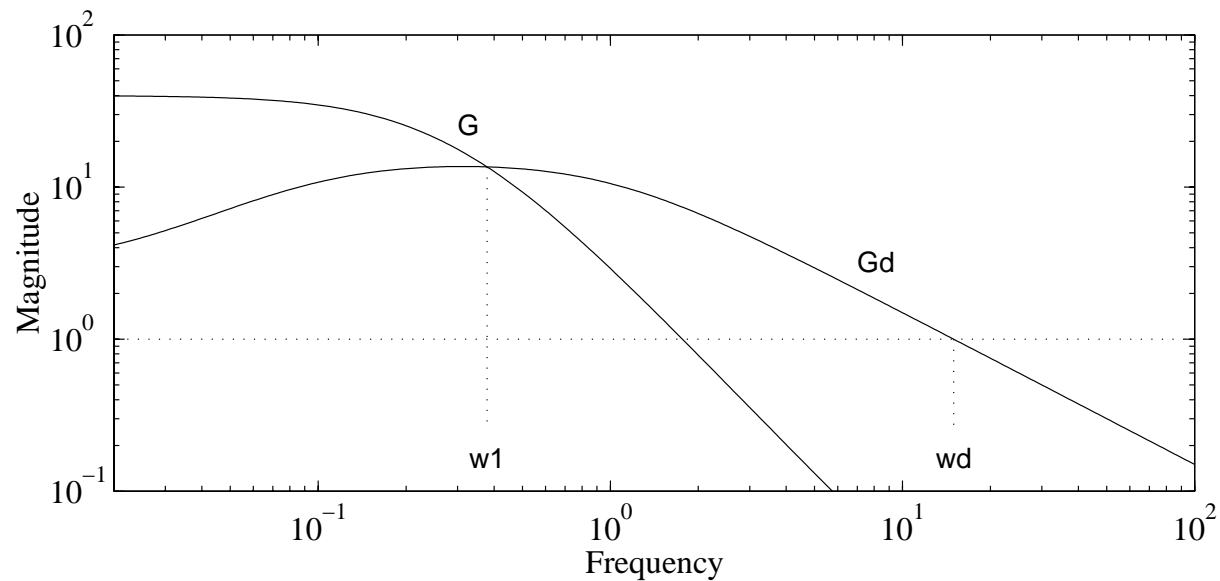

Input saturation is expected for disturbances at intermediate frequencies from ω_1 to ω_d

A buffer tank may be added to reduce the effect of a disturbance.

It reduces the disturbance effect at frequencies above $1/t_{buffer}$.

1. Reduces ω_d and thus the requirement for speed of response
2. Lowers $|G_d|$ and thus the requirement for input usage.

IDEAL CONTROL WITH DELAY AND RHP ZERO

Plant with RHP-zeros at z_i and time delay θ .

Setpoint tracking:

$$y = Tr$$

Ideal ISE-optimal control with no input penalty:

$\min_K |y \ominus r|^2$ for step in r (no weight on u).

Yields (Morari and Zafiriou, 1989):

$$T = \prod_i \frac{\ominus s + z_i}{s + \bar{z}_i} e^{-\theta s} \quad (5)$$

Loop transfer function $L = T/(1 \ominus T)$,

Bandwidth : approximately frequency where $|L(j\omega)|$ crosses 1.

Will use (5) to find “ideal” bandwidth .

3. TIME DELAY

Ideal complementary sensitivity

$$T = e^{-\theta s}$$

Since $L = T/(1 \Leftrightarrow T)$ we get

$$L = \frac{e^{-\theta s}}{1 \Leftrightarrow e^{-\theta s}}$$

At low frequencies, $\omega < 1/\theta$:

$$L \approx \frac{1}{\theta s}$$

$\Rightarrow |L| \approx 1$ at $\omega = 1/\theta$. Thus, in practice

$$\omega_B < 1/\theta$$

or

$$\tau_c > \theta$$

4. INVERSE RESPONSE – RHP ZERO

Real RHP-zero at $s = z \Rightarrow$ Inverse response.

Ideal complementary sensitivity

$$T = \frac{\Leftrightarrow s + z}{s + z}$$

Get

$$L = 0.5 \frac{\Leftrightarrow s + z}{s}$$

$\Rightarrow |L| \approx 1$ at $\omega = z/2$. Thus

$$\omega_B < 0.5z$$

or

$$\tau_c > 2\theta_z \quad \text{where} \quad \theta_z = \frac{1}{z}$$

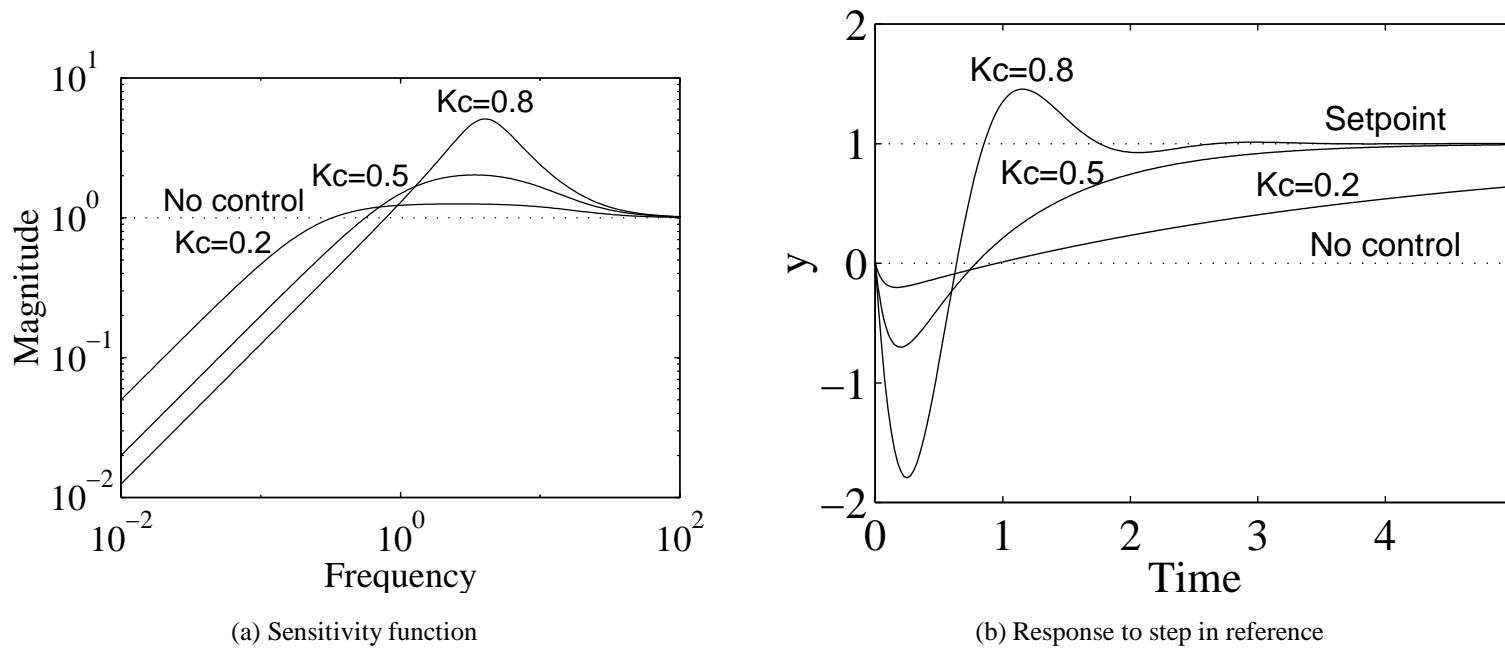

Figure 1: Control of plant with RHP-zero at $z = 1$ using negative feedback

$$G(s) = \frac{\Leftrightarrow s + 1}{s + 1}$$

$$K(s) = K_c \frac{s + 1}{s} \frac{1}{0.05s + 1}$$

$K_c = 0.5$ corresponds to “ideal” response in terms of minimum ISE

REMARKS ON BOUNDS

$$\omega_B < 1/\theta; \omega_B < 0.5z = 0.5/\theta_z \quad (6)$$

1. Recall Pade: $e^{-\theta s} \approx \frac{1-\frac{\theta}{2}s}{1+\frac{\theta}{2}s}$
2. Bounds independent of scaling.
3. Provide a quantification of the rules
 - “Control outputs that have favorable dynamic and static characteristics, i.e., there should exist an input with a significant, direct and rapid effect.”
 - “Select inputs that rapidly effect the controlled variables.”
4. If bandwidth exceeds these bounds: Oscillatory response (with large peak in T and S).
5. Similar restrictions apply to feedforward control.
6. LHP Zeros (“overshoots” in time response): No fundamental limitation on control, but in practice a LHP-zero close to 0 causes problems.
 - (a) Input constraints (gain is often low).
 - (b) A simple controller (PID) can probably not be used.

7. For RHP-zero: May reverse controller gain and achieve instead tight control at $\omega > z$, but poor control around $\omega = z$ is unavoidable.

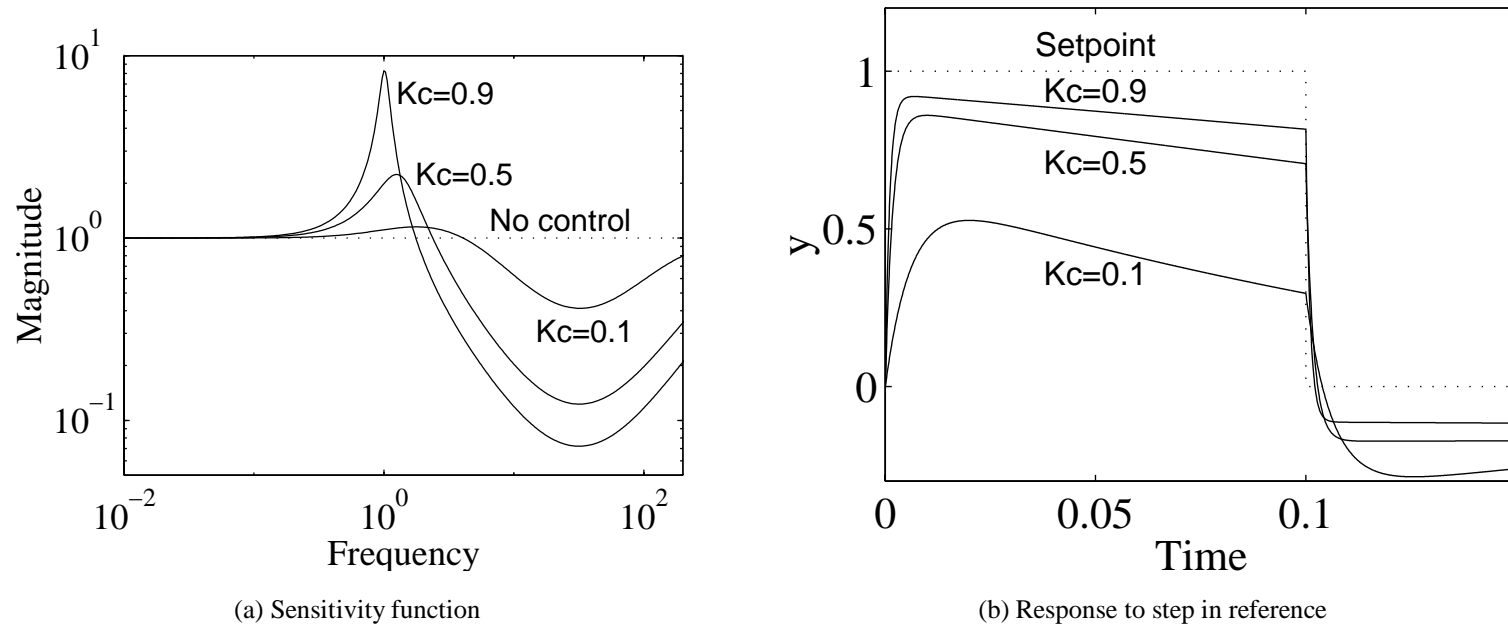

Figure 2: Control of plant with RHP-zero at $z = 1$ using positive feedback.

$$G(s) = \frac{\Leftrightarrow s + 1}{s + 1}$$

$$K(s) = \Leftrightarrow K_c \frac{s}{(0.05s + 1)(0.02s + 1)}$$

5. PHASE LAG

Minimum-phase process

$$G(s) = \frac{k}{(\tau_1 s + 1)(\tau_2 s + 1)(\tau_3 s + 1) \cdots}$$

where τ_1 is the largest time constant etc.

- Gain drops sharply at high frequency: Possible problems with input constraints (depending on value of k).
- Otherwise: No **fundamental** problem.
- BUT in practice the large phase lag at high frequencies is a problem **independent** of value of k .

$$\text{Practical bound : } \omega_B < \omega_{g180}$$

where ω_{g180} is frequency where $\angle g = \Leftrightarrow 180^\circ$. (Balchen and Mumme, 1989).

- In practice, small lags are collected into an “effective delay”. With PI-control use

$$\theta_\tau = \frac{\tau_2}{2} + \sum_{i \geq 3} \tau_i$$

- To simplify, we can collect all delays, small time constant, and RHP-zeros into an overall “effective delay”

$$G(s) = \frac{k e^{-\theta s} (\Leftrightarrow \theta_z s + 1)}{(\tau_1 s + 1)(\tau_2 s + 1)(\tau_3 s + 1) \cdots}$$

Use

$$\theta_{eff} = \theta + \theta_z + \frac{\tau_2}{2} + \sum_{i \geq 3} \tau_i$$

Must approximately require

$$\omega_B < 1/\theta_{eff} \quad \text{or} \quad \tau_c > \theta_{eff}$$

6. INSTABILITY

$$g(s) = \frac{1}{s \Leftrightarrow p}$$

One “limitation” : **Feedback control** is required.

Use P -controller $c(s) = K_c$. Get

$$L(s) = \frac{K_c}{s \Leftrightarrow p}$$

$|L|$ crosses 1 at $\omega_B = K_c$. Furthermore

$$S(s) = \frac{1}{1 + L(s)} = \frac{s \Leftrightarrow p}{s \Leftrightarrow p + K_c}$$

\Rightarrow need $K_c > p$ to stabilize plant.

$K_c = 2p$ gives minimum input usage for stabilization

Conclusion: Bandwidth needed for unstable plant

$$\omega_B > 2p \quad \text{or} \quad \tau_c < 0.5/p$$

1. “Must respond quicker than time constant of instability ($1/p$)”.
2. **Instability and RHP-zero.** For RHP-zero found $\omega_B < 0.5z$. Combine with ():

$$p < 0.25z \quad \text{for acceptable control}$$

More generally:

Stable stabilizing controller exists only if $p < z$ (Youla, 1974).

COMBINATION OF EFFECTS

1. **Disturbance and RHP-zero (inverse response).** Must at least require for acceptable output performance ($|e| < 1$)

$$|G_d(z)| < 1$$

Similarly for time delay

$$G_d(j\frac{1}{\theta}) < 1$$

2. **Unstable plant.** Must at least require to stabilize with acceptable input usage ($|u| < 1$) (Havre and Skogestad, 1997)

$$|G_s(p)| > |(G_d)_{ms}(p)|$$

$$|G_s(p)| > |N(p)|$$

where

G_s - "stable" version with $s \Leftrightarrow p$ replaced by $s + p$

$(G_d)_{ms}$ - "stable" and "minimum-phase" version

$N(s)$ - magnitude of measurement noise

Example.

$$G(s) = \frac{1}{s \Leftrightarrow 10}; \quad G_s(s) = \frac{1}{s + 10}; \quad p = 10$$

Must require that the measurement noise is less than

$$N < \frac{1}{10 + 10} = 0.05$$

Plant gain must be larger than measurement noise at frequencies p corresponding to the instability.

SUMMARY OF CONTROLLABILITY RESULTS

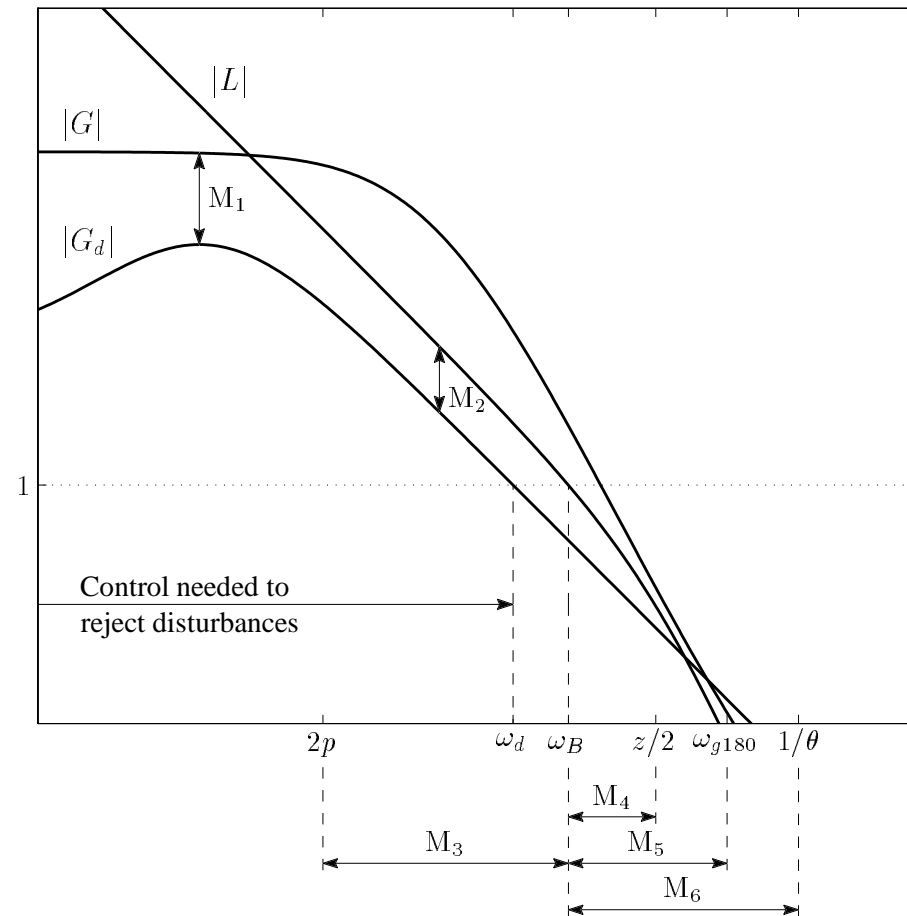

Margins for stability and performance:

M_1 : Margin to stay within constraints, $|u| < 1$.

M_2 : Margin for performance, $|e| < 1$.

M_3 : Margin because of RHP-pole, p .

M_4 : Margin because of RHP-zero, z .

M_5 : Margin because of phase lag, $\angle G(j\omega_{g180}) = -180^\circ$.

M_6 : Margin because of delay, θ .

Margins M_4 - M_6 can be combined into $\omega_B < 1/\theta_{eff}$

POOR CONTROLLABILITY CAN BE CAUSED BY:

Now we can quantify!

1. Delay or inverse response in $G(s)$. Need

$$\tau_c > \theta$$

2. or $G(s)$ is of “high order” (tanks-in-series) so that we have an “apparent delay”. Need

$$\tau_c > \theta_{eff}$$

3. Constraints in the plant inputs (a potential problem if the plant gain is small). Need

$$|G| > |G_d| \quad \text{at frequencies where } |G_d| > 1$$

$$|G| > R \quad (\text{where typically } R > 1)$$

4. Large disturbance effects (which require “fast control”

$$\tau_c < 1/\omega_d$$

and/or large plant inputs to counteract.

5. Instability: Feedback with the active use of plant inputs is required. Need

$$\tau_c < 1/p$$

May be unable to react sufficiently fast if there is an effective delay in the loop. And: May have problems with input saturation if there is measurement noise or disturbances. Need

$$|G_s(p)| > |N(p)|$$

6. MIMO plant gain: May not be able to control all outputs independently if the “worst case” plant gain $\underline{\sigma}(G)$ is small. Need

$$\underline{\sigma}(G) > R \quad (\text{where typically } R > 1)$$

EXERCISES

Problem 1

$$G(s) = \frac{2}{s+1} \quad G_d(s) = \frac{3}{5s+1}$$

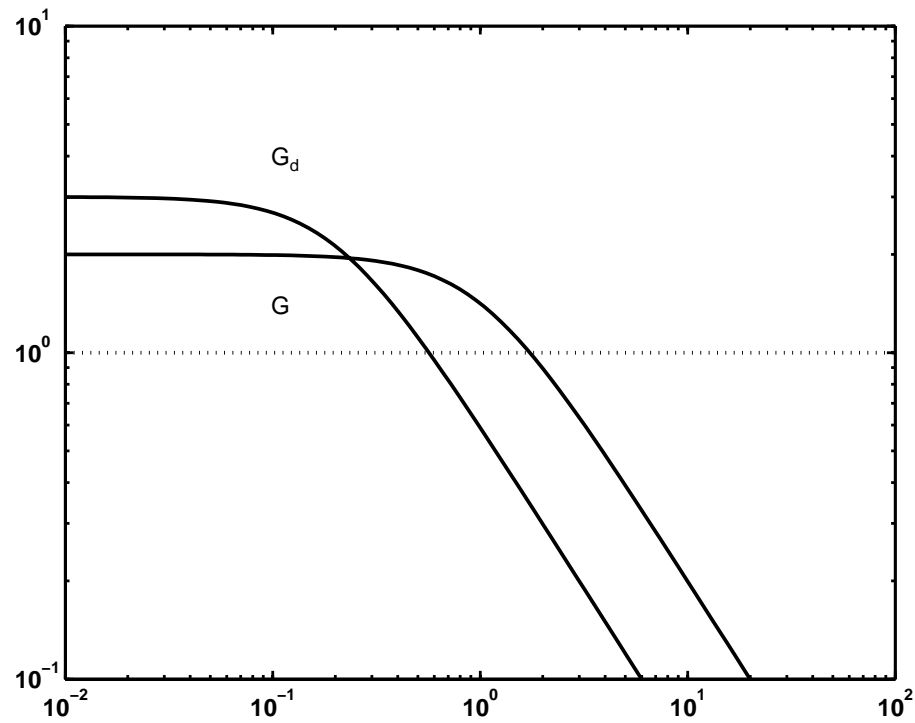
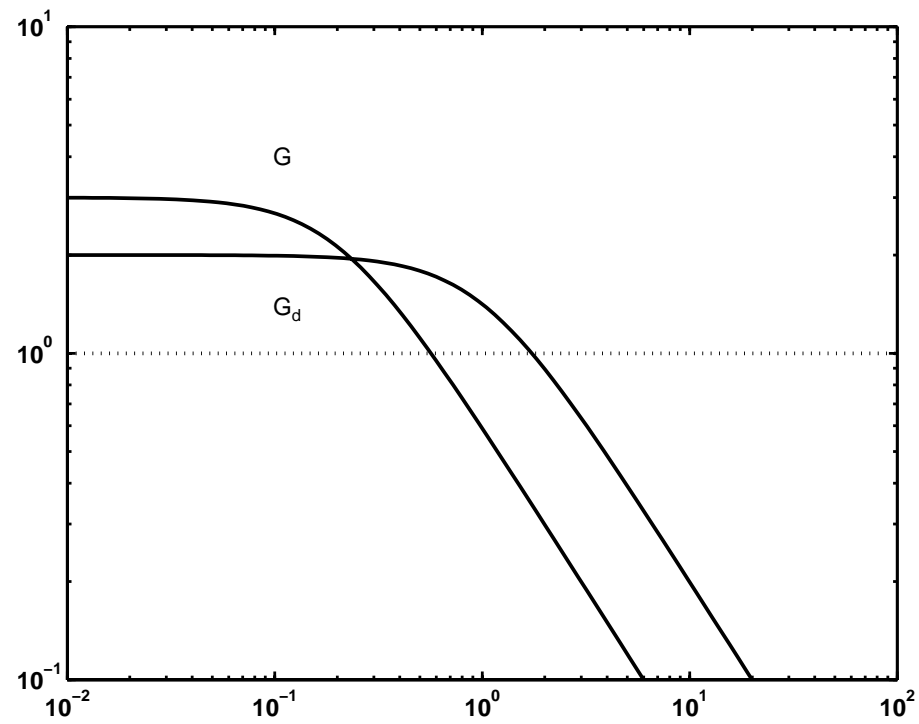

Figure 3: Magnitude of G and G_d .

Problem 2

$$G(s) = \frac{3}{5s + 1} \quad G_d(s) = \frac{2}{s + 1}$$



Problem 3

Given

$$G(s) = \frac{3}{5s + 1} \quad G_d(s) = 7.5 \frac{s \Leftrightarrow 0.8}{(s + 0.2)(s + 20)}$$

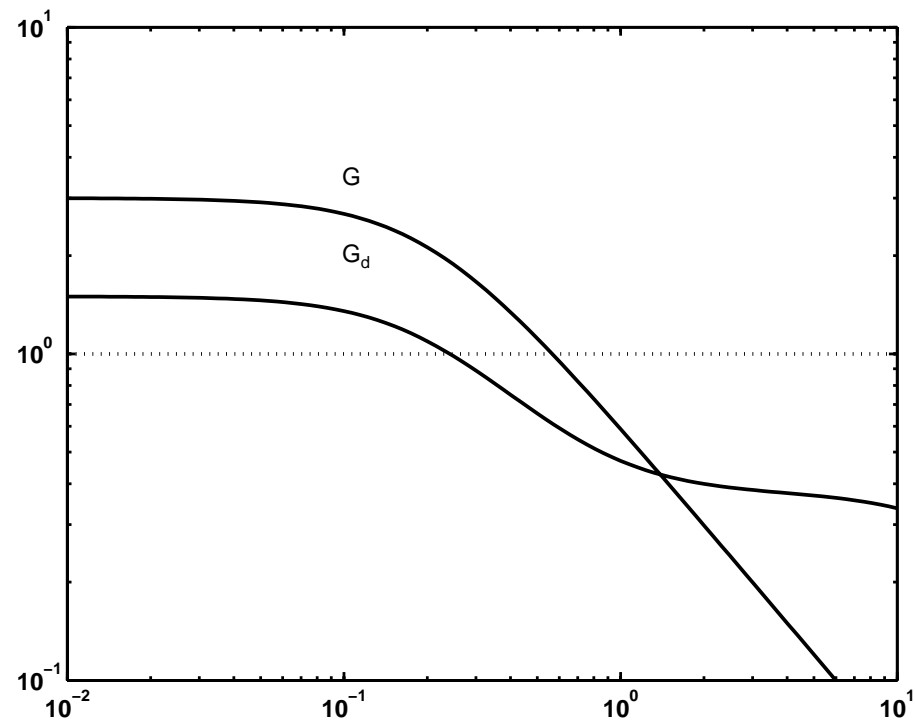
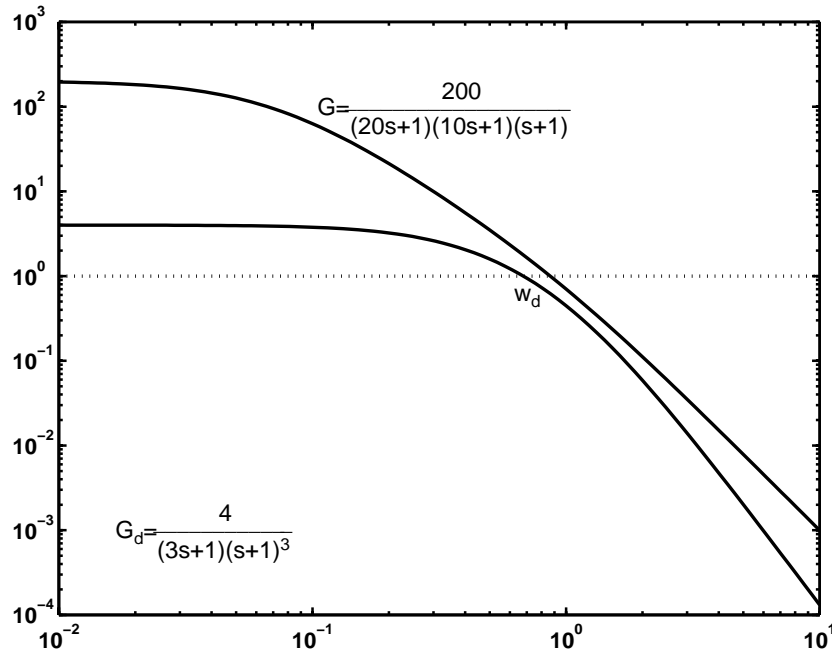

Figure 4: Magnitude of G and G_d .

Problem 4

$$G(s) = \frac{200}{(20s + 1)(10s + 1)(s + 1)} \quad G_d(s) = \frac{4}{(3s + 1)((s + 1)^3)}$$



(a) Magnitude of G and Gd

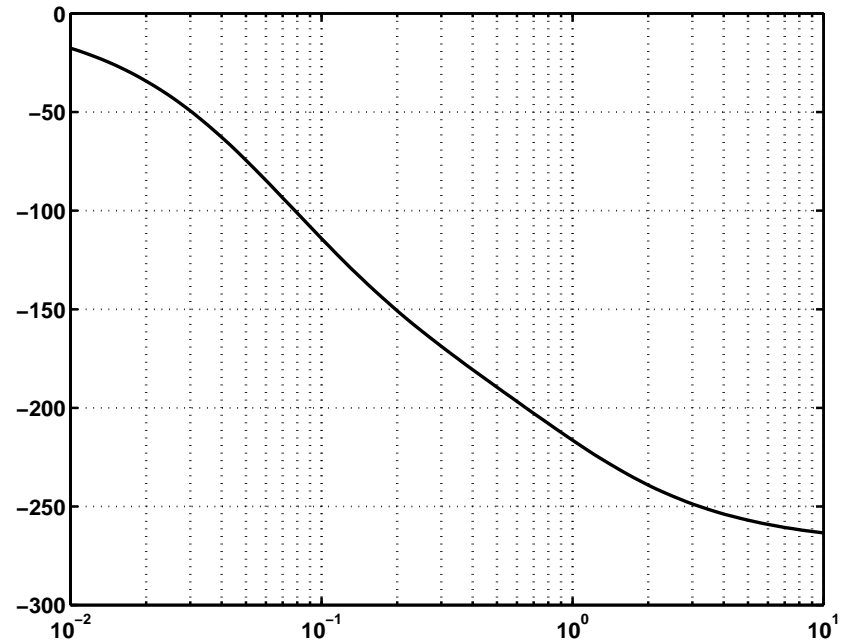

(b) Phase plot of G

Problem 5

$$G(s) = \frac{2.5e^{-0.1s}(1 \Leftrightarrow 5s)}{(3s + 1)((s + 1)^3)} \quad G_d(s) = \frac{2}{s + 1}$$

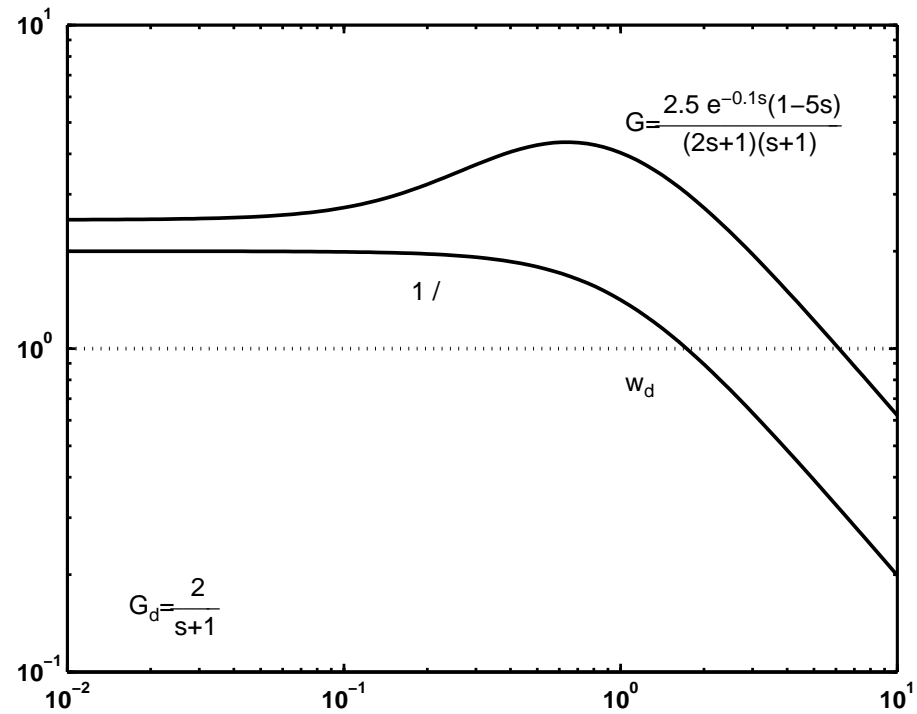

Figure 5: Magnitude of G and G_d .

y = concentration of product (meas. delay $\theta=10$ s)

u = Flow_{base}

d = Flow_{acid}

Introduce excess of acid $c = c_H \Leftrightarrow c_{OH}$ [mol/l].

In terms of c the dynamic model is a simple mixing process !!

$$\frac{d}{dt}(Vc) = q_A c_A + q_B c_B \Leftrightarrow qc$$

Model for pH Example

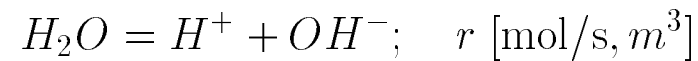
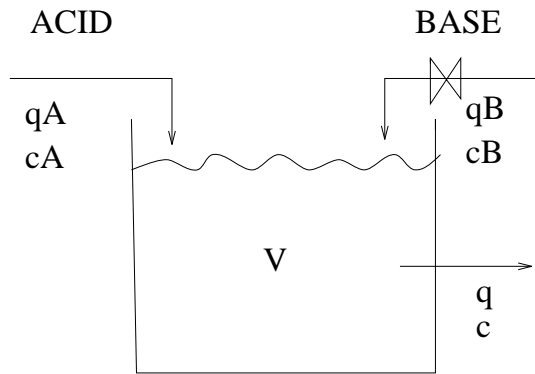

Material balances:

c_H [mol/l], c_{OH} [mol/l] : conc. of H^+ and OH^- -ions.

$$\frac{d}{dt}(Vc_H) = q_Ac_{H,A} + q_Bc_{H,B} \Leftrightarrow qc_H + rV$$

$$\frac{d}{dt}(Vc_{OH}) = q_Ac_{OH,A} + q_Bc_{OH,B} \Leftrightarrow qc_{OH} + rV$$

Introduce excess acid, $c = c_H \Leftrightarrow c_{OH}$ and add equations:

$$\frac{d}{dt}(Vc) = q_Ac_A + q_Bc_B \Leftrightarrow qc$$

(Material balance for mixing tank without reaction !!)

Linearization and Laplace transform

$$c(s) = \frac{1}{1 + \tau s} \left(\frac{c_A^* \Leftrightarrow c^*}{q^*} q_A(s) + \frac{c_B^* \Leftrightarrow c^*}{q^*} q_B(s) \right); \quad \tau = V/q^*$$

Excess acid c [mol/l]

- $c = 0$ [mol/l] \Leftrightarrow pH=7
- $c = 10^{-6}$ [mol/l] \Leftrightarrow pH=6
- $c = \Leftrightarrow 10^{-6}$ [mol/l] \Leftrightarrow pH=8
- Want $c = 0 \pm c_{max}$ where $c_{max} = 10^{-6}$

Scaled variables

$$y = \frac{c}{10^{-6}}; \quad u = \frac{q_B}{5[l/s]}; \quad d = \frac{q_A}{2.5[l/s]}$$

Scaled linear model

$$y = \frac{k_d}{\tau s + 1} (\Leftrightarrow 2u + d); \quad k_d = 2.5 \cdot 10^6 \quad \tau = V/q = 1000s$$

EXTREMELY SENSITIVE TO DISTURBANCES.

Controllability analysis

$$G = \Leftrightarrow 2 \frac{k_d}{\tau s + 1}, \quad G_d = \frac{k_d}{\tau s + 1}$$

- Input constraints: No problem since $|g| = 2|G_d|$ at all frequencies.
- Main control problem: High disturbance sensitivity. The frequency up to which feedback is needed

$$\omega_d \approx k_d/\tau = 5000 \text{ rad/s}$$

Requires a response time $\tau_r < 1/5000 = 0.2$ millisecond.

- Physically: Increase acid flow by 50% (max disturbance): Takes 0.2 millisecond for pH to drop from 7 to 6.

Conclusion: Process is impossible to control irrespective of controller design.

With n tanks: $G_d(s) = k_d/(1 + \tau s)^n$.

τ : residence time in each tank.

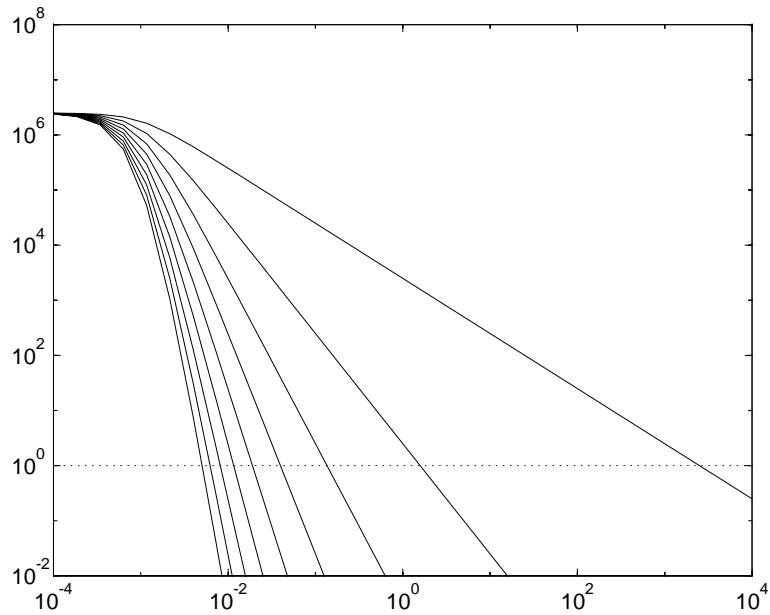

To reject disturbance must require

$$|G_d(j\frac{1}{\theta})| < 1$$

where θ is the measurement delay. Gives

$$\tau > \theta \sqrt{(k_d)^{2/n}} \Leftrightarrow 1$$

Total volume : $V_{tot} = n\tau q$ where $q = 0.01 \text{ m}^3/\text{s}$.

With $\theta = 10$ s the following designs have the same controllability:

No. of tanks n	Total volume $V_{tot} [m^3]$	Volume each tank $[m^3]$
1	250000	250000
2	316	158
3	40.7	13.6
4	15.9	3.98
5	9.51	1.90
6	6.96	1.16
7	5.70	0.81

Minimum total volume: 3.66 m^3 (18 tanks of 203 l each).

Economic optimum: 3 or 4 tanks.

Agrees with engineering rules.

Remarks

1. Traditional “feedforward” thinking: Main problem is the accuracy needed in adding base to counteract the acid disturbance.

This argument is **not** valid for feedback control.

Main problem for feedback: Output is extremely sensitive to disturbances (k_d and ω_d large), which requires extremely high bandwidth.

2. Our results yield same result as “Ziegler-Nichols” analysis by McMillan (1983), but step response analysis of Walsh and Perkins (1993, 1994) is too optimistic.
3. To minimize the total volume: Optimal to have tanks of equal size.
18 tanks yields minimum volume in our case.
4. With cost data from Walsh (1993, p. 31): 3 tanks is best
(capital cost is 97 kGBP for 3 tanks versus 101 kGBP for 4 tanks).

Conclusion pH-example

- Used frequency domain controllability procedure
- Heuristic design rules follow directly
- Key point: Consider disturbances and scale variables
- Example illustrates design of buffer tank for composition/temperature changes
- Can use same ideas to design buffer tank for flowrate changes (there we must also consider the level controller)

MIMO CONTROLLABILITY ANALYSIS

- Most of the SISO rules generalize.
- Main difference: Directionality.

Important tool to understand gain directionality: Singular Value Decomposition (SVD)

MIMO CONTROLLABILITY ANALYSIS

1. Scale all variables
2. SVD of G (and possibly also G_d)
3. Check if all outputs can be controlled independently.
 - (a) At least as many inputs as outputs
 - (b) “Worst-case” gain sufficiently large.

$$\underline{\sigma}(G) > 1, \omega < \omega_B$$

Smallest singular value larger than 1 up to the desired bandwidth (otherwise we cannot make independent ± 1 changes in all outputs)

4. Check for multivariable RHP-zeros (which generally are **not** related to the element zeros. Compute their associated output *directions* to find which outputs may be difficult to control.

5. Unstable plant. Compute the associated directions for the RHP-poles. Can also be used to assist in selecting a stabilizing control structure (see Tennessee Eastman example).

6. Compute relative gain array

$$\text{RGA} = G \times G^{\dagger T}$$

as a function of frequency (bandwidth frequencies most important!).

Large RGA-elements means that the plant is fundamentally difficult to control (use pseudo-inverse G^{\dagger} so also applies to non-square plant).

7. **Disturbances** Consider elements in

$$G^{\dagger} G_d$$

Should all be less than 1 to avoid input saturation.

DISTILLATION EXAMPLE

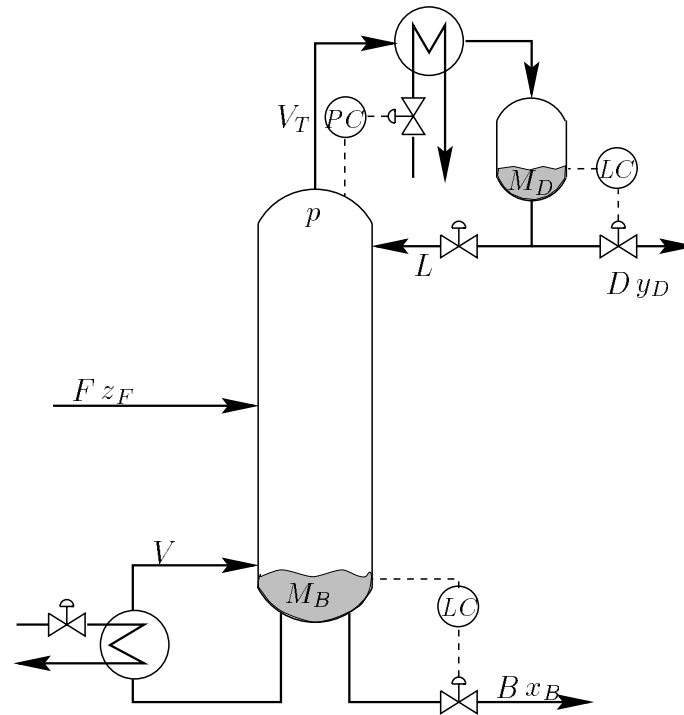

$$u = \begin{pmatrix} L \\ V \end{pmatrix}; \quad y = \begin{pmatrix} y_D \\ x_B \end{pmatrix} \text{ [mol} \Leftrightarrow \text{\% light]}$$

Steady-state gains $y = Gu$

$$G(o) = \begin{bmatrix} 87.8 & \Leftrightarrow 86.4 \\ 108.2 & \Leftrightarrow 109.6 \end{bmatrix}$$

- Most sensitive input directions is $v_1 = \begin{pmatrix} 0.71 \\ \Leftrightarrow 0.71 \end{pmatrix}$ (increase L and decrease V).
 - Physically, this corresponds to changing the external flow split from top to bottom
 - Its effect on the compositions is $\sigma_1 u_1 = 197.2 \begin{pmatrix} 0.63 \\ 0.78 \end{pmatrix}$, i.e. increase y_D (purer) and also x_B (less pure).
 - The effect is large because the compositions are sensitive to the ratio D/B
- The least sensitive input directions is $v_2 = \begin{pmatrix} 0.71 \\ 0.71 \end{pmatrix}$ (increase L while decreasing V by the *same* amount
 - Physically, this corresponds to increasing the *internal flows* (with no change in the external flows split)
 - Its effect on the compositions is $\sigma_2 u_2 = 1.4 \begin{pmatrix} 0.78 \\ \Leftrightarrow 0.63 \end{pmatrix}$
 - As expected, this makes both products purer and has a much smaller effect.
 - σ_2 is the minimum singular value; usually denoted $\underline{\sigma}$

- **Condition number**, $\gamma = \sigma_1/\underline{\sigma} = 197.2/1.4 = 141.7$
- A large condition number shows that some directions have a much larger gain than others, **but** does not necessarily imply that the process is difficult to control
- **Minimum singular value**. BUT if $\underline{\sigma}(G)$ is small (less than 1) then we may encounter problems with input saturation.
- For example, assume the variables have been scaled and $\underline{\sigma}(G) = 0.1$. Then in the “worst direction” a unit change (maximum allowed) in the inputs only gives a change of 0.1 in the outputs.
- **Relative Gain Array (RGA)**

$$RGA = G \times (G^{-1})^T = \begin{bmatrix} 35.07 & \Leftrightarrow 34.07 \\ \Leftrightarrow 34.07 & 35.07 \end{bmatrix}$$

- RGA yields sensitivity to gain uncertainty in the input channels. If the RGA-elements are large then the process is fundamentally difficult to control

NOTE: Due mainly to liquid flow dynamics the process is much less interactive at high frequencies
⇒ Control is not so difficult if the loops are tuned tightly

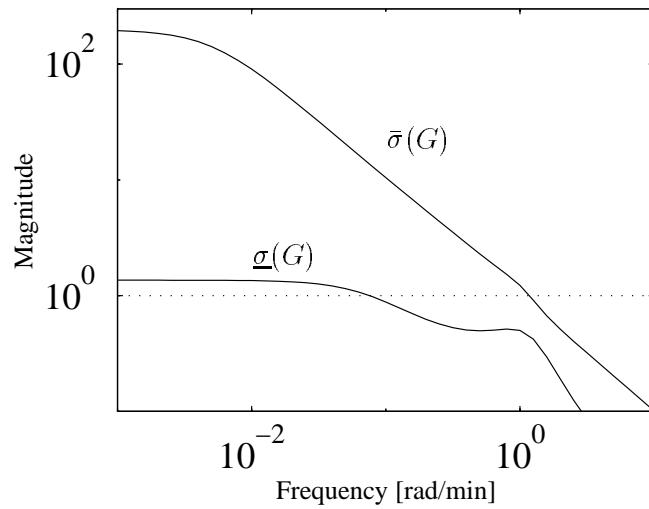

(a) Singular values

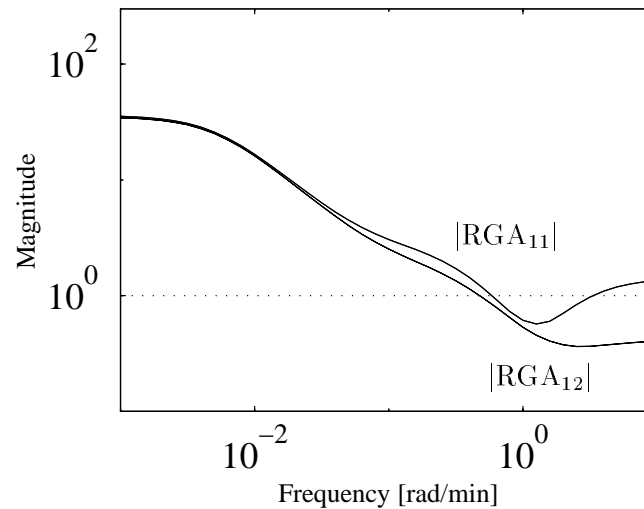

(b) RGA-elements

DISTILLATION CONFIGURATIONS

Typically, overall control problem has 5 inputs

$$u = (L \quad V \quad D \quad B \quad V_T)$$

(flows: reflux L , boilup V , distillate D , bottom flow B , overhead vapour V_T)
and 5 outputs

$$y = (y_D \quad x_B \quad M_D \quad M_B \quad p)$$

(compositions and inventories: top composition y_D , bottom composition x_B , condenser holdup M_D , reboiler holdup M_B , pressure p)

There are usually three “unstable” outputs

$$y_2 = (M_D \quad M_B \quad p)$$

Remaining outputs

$$y_1 = (y_D \quad x_B)$$

Many possible choices for the three inputs for stabilization. For example, with

$$u_2 = (D \quad B \quad V_T)$$

we get the LV -configuration where

$$u_1 = (L \quad V)$$

are left for composition control.

Another configuration is the DV -configuration where

$$u_1 = (D \quad V)$$

Analysis of alternatives

Without any control we have a 5×5 model

$$y = Gu + G_d d$$

After closing the stabilizing loops ($u_2 \leftrightarrow y_2$) we get a 2×2 model for the remaining “partially controlled” system

$$y_1 = G^{u_1} u_1 + G_d^{u_1} d$$

where there are many possible choices for u_1 (“configurations”)

- LV, DV, DB, L/D V/B etc.

Which configurations is the best?

Analyze G^{u_1} and $G_d^{u_1}$ with respect to

1. No composition control

- Consider disturbance gain $G_d^{u_1}$ (e.g. effect of feedrate on compositions)

2. Close one composition loop (“one-point control”)

- Consider partial disturbance gain (e.g. effect of feedrate on y_D with constant x_B)

3. Close two composition loops (“two-point control”)

- Consider interactions in terms of RGA
- Consider “closed-loop disturbance gains” (CLDG) for single-loop control

Problem:

- No single best configuration
- Generally, get different conclusion on each of the three cases
- \Rightarrow Stabilizing control is not necessarily a trivial issue

CONTROLLABILITY ANALYSIS OF VARIOUS DISTILLATION CONFIGURATIONS

- S. Skogestad, “Dynamics and control of distillation columns: A tutorial introduction”, *Trans IChemE* (UK), **75**, Part A, 1997, 539 - 561.

PLANTWIDE DYNAMICS

- Poles are affected by recycle of energy and mass and by interconnections
- Parallel paths may give zeros - possible control problems
- Recycle yields positive feedback and often large *open-loop* time constants
- This does *not* necessarily mean that *closed-loop* must be slow
- See MYTH on distillation control where open-loop time constant for compositions is long because of positive feedback from reflux and boilup
- Luyben's "snowball effect" is mostly a steady-state design problem (do not feed more than the system can handle...)

PLANTWIDE CONTROL

- Where is the production rate set?
- Degrees of freedom - local “tick-off” can be useful
- Extra inputs
- Extra measurements
- Selection of variables for control
- Configuration for stabilizing control may effect layers above (including easy of model predictive control)
- One tool for stabilizing control: Pole vectors (see Tennessee Eastman example)

Alt.1 "Cascade of SISO loops" - Control structure design

- Local feedback
- Close loop - same number of DOFs but uses up dynamic range
- Cascades - extra measurements,
- Cascades - extra inputs
- Selectors
- RGA

Alt.2 "Optimization": Multivariable predictive control

- Model-based
- Mostly feedforward based
- Excellent for extra inputs and changes in active constraint
- Feedback somewhat indirectly through model update.

Alt.3 Usually: A combination of feedback and models.

- How to find the right balance

TUNING OF LEVEL CONTROLLERS

$$G(s) = k'/s$$

where k' [m/min] is the slope of integrating response

PI-controller

$$K(s) = K_c \frac{\tau_I s + 1}{\tau_I s}$$

- P-controller often sufficient ($\tau_I = \infty$)

$$K_c = \frac{1}{k'\tau_c}$$

– τ_c - tuneable closed-loop time constant

– Typical, $\tau_c = 2\theta_{eff}$

- If you insist on integral action: Use

$$k'K_c\tau_I > 4$$

i.e. $\tau_I > 4\tau_c$ to avoid oscillations (easily derived).

- Operators (and engineers) often detune gain in PI-controller because it oscillates – If the gain is already too low it may oscillating even more – should increase τ_I instead.

- If the tank is a buffer tank to dampen flowrate changes then the slowest possible P-controller is optimal

$$\Delta h = K_c \Delta q; \quad K_c = \frac{q_{max} \Leftrightarrow q_{min}}{h_{max} \Leftrightarrow h_{min}}$$

“Floating level control” .

If nominally in the middle, it gives $h = h_{max}$ when $q = q_{max}$ and $h = h_{min}$ when $q = q_{min}$.

CONCLUSION

- Steps in controllability analysis
 1. Find model and linearize it (G, G_d)
 2. Scale all variables within ± 1
 3. Analysis using controllability measures
- Have derived rigorous measures for controllability analysis, e.g.

$$|G_d(j\frac{1}{\theta})| < 1$$

- Use controllability analysis for:
 - What control performance can be expected?
 - What control strategy should be used?
 - * What to measure, what to manipulate, how to pair?
 - How should the process be changed to improve control?
 - Tools are available in MATLAB (see my book on Multivariable control and its home page)