

Modelling and Dynamic Simulation for Process Control: Issues in dynamic modelling using distillation as an example

Sigurd Skogestad

Institutt for Kjemiteknikk
NTH
N-7034 Trondheim

August 27, 1991

Lecture notes at seminar on
Modelling and Optimization of Chemical Processes
NTH, Trondheim, 26- 28 August 1991.¹

Abstract

Dynamic process models are useful for a number of purposes during design and operation of chemical processes. In this paper the general principles for model development are outlined, and these principles are applied to a simple flash tank (which appears to be a lot more interesting than one might believe at first sight) and to a distillation column example. Detailed numerical simulation is discussed only briefly, and it is shown that one in some cases may get an "index" problem which may pose problems for standard integration methods.

The emphasis of the paper is to demonstrate how one by linearization and simplifications can obtain simple low-order models. For example, we derive simple analytical expressions for the time constants of the pressure and concentration response for the flash tank and distillation column. Such simple models may yield invaluable process insight. In addition, simple models are often needed for process control or for simplified simulation studies (eg., training simulators).

¹These notes are an updated version of a paper originally presented at Kursdagene, NTH in Jan. 1990

1 Introduction

A model is a quantification of a physical process that enables prediction of process behavior. Denn (1986) gives the following definition:

A mathematical model of a process is a system of equations whose solution, given specified input data, is representative of the response of the process to a corresponding set of inputs.

In this paper we consider dynamic process models obtained using fundamental principles (eg. based on the conservation laws); possibly combined with parameter fitting to match observations of the real process. Empirical (black box) models may be obtained from observations only (process identification, spectral analysis). Such models may generally only be used for smoothening of data and may not safely be used to predict the behavior of the system at other operating conditions.

Within chemical engineering models may be used for several purposes. Some of these are:

1. Process (equipment) design
2. Process (setpoint) optimization (off- and on-line)
3. Troubleshooting (off-line)
4. Process monitoring (on-line)
5. Operator training
6. Establish procedures for startup, shutdown, or for handling failures
7. Process control

In Case 1 the process parameters (setpoints) are fixed and the size of equipment is to be calculated. Steady-state models usually suffice. There are some exceptions, for example, batch processes which are inherently dynamic and the design of safety and relief systems. Steady-state models usually are sufficient also in case 2. Steady-state models may also often be used also in cases 3 and 4. In fact, models may not be needed at all in case 4 (process monitoring). For example, to monitor the possible runaway of a chemical reactor, a simple trend analysis using temperature measurements may be sufficient. Dynamic models are clearly needed for operator training (case 5) and for simulating special dynamic transients (case 6), and it is here important to have a good model of the dominating ("slow") dynamics and of the steady-state effects.

For controller design (case 7) simple black-box models describing the "fast" dynamics (in particular dead times) are often sufficient. A good fit of the steady-state is generally not needed



Example of poor model of author

- the reason is that feedback control brings the system back to its original steady-state. As an illustration consider the Ziegler-Nichols rules for tuning of PID controllers which use information about the process when it is oscillating, and which use no information about the steady-state. The models used for controller design are usually linear, but nonlinear simulations are often used to verify that the control system will work in practice.

This paper is concerned with fundamental dynamic models. From the list above we see that there are only few cases where such a model actually may be needed. This probably explains why there has been relatively little emphasis put on dynamic modelling within chemical engineering. However, dynamic models are very helpful for obtaining insight and understanding about the process. For example, insight about the dynamic couplings in a process may be very useful for the engineer to establish the *structure* of the control system (pairing of variables, control specifications, etc.), although the design of the individual controllers may not require a very sophisticated model. The benefits of improved operation caused by operators who have been trained using dynamic simulation are quite obvious.

In many cases the development of a dynamic model for a process goes through the following steps

1. Establish a model using fundamental balance equations for mass, energy etc. (Accumulation = In - Out). Combine this with, for example, thermodynamic relationships for vapor-liquid equilibrium (VLE) and equations of state ($p = f(M_V, V_V, T)$).
2. Obtain fundamental parameters for model, for example, equilibrium constants and physical data
3. Solve equations numerically
4. Obtain additional parameters by matching response of actual process (or verify the model if all parameters are known)

In general, the steps in this procedure may be iterative and in a different order from that outlined above.

Step 1 and 2 is usually the same for both steady-state and dynamic models with the exception that the Accumulation term is set to zero in the steady-state case. However, the dynamic model has additional parameters which may make step 4 significantly more difficult. These additional parameters include the nominal (steady-state) values of the accumulation terms (holdups) and information on how these holdups vary with load (eg., time constants for self regulation of holdups). Preferably these parameters should be obtained from fundamental knowledge or independent experiments, rather than trying to match simulations of the model with experimental responses.

Consider the case of establishing a simulation model for an existing distillation column. Step 1 involves setting up mass and energy balances for each individual tray. In step 2 vapor-liquid equilibrium (VLE) relations and enthalpy data are introduced. Such data is generally obtained from an independent source and are not adjusted later. Step 4: In the steady-state case the only remaining parameter is now the tray efficiency in the various sections of the column. Since the methods for estimating tray efficiency are generally unreliable, these are usually obtained by matching steady-state plant data. This is usually done for a given feed by specifying the product compositions and then adjusting the tray efficiency in order to match the experimental data (flows and temperature profiles) as well as possible. Fundamental models of distillation columns are usually very accurate if the VLE data is accurate. Deviations between calculated and experimental data are usually caused by errors in the experimental data. For example, the column may not be operating at steady state, or the reported values for flows or compositions may be erroneous. In the dynamic case values for the holdups of liquid on the trays must be obtained in addition. The number of parameters should be reduced by assuming, for example, the trays to be identical.

The numerical solution (step 3) is sometimes the most time consuming, but hopefully will become less of a burden in the future as more powerful software and computers become available.

The level of modelling detail is an important issue. There are a number of reasons why one should try to keep a model as simple as possible. Using a simple model makes it easier to understand and correct, avoids errors and saves time. In addition, there are two even more fundamental reasons: 1) If the model is too complex then it may be unsolvable with the current computing power. 2) It may require a large number of parameters which are not available from independent sources. Although the art of modelling may be formalized to some degree, the results will nevertheless depend strongly on the experience and intuition of the engineer. The art is to make a simple yet sound model by making the appropriate simplifications and assumptions using incomplete data.

2 Dynamic modelling using the Conservation Principle

2.1 Degrees of freedom

Before we start with the actual modelling some comments about independent variables and degrees of freedom seems appropriate. A mathematical model consists of a set of equations and variables. This model will have a given number of degrees of freedom and the corresponding number of variables may be specified. In

principle, any variable may be specified although a physical solution may not be guaranteed for any specification. However, note that if we consider a dynamic model for a given process, then the “true” independent variables, from a physical point of view, will almost always correspond to valves (flow rates). Additional independent variables associated with streams entering the system (eg., feed composition) are usually denoted disturbances. In most cases the engineer does not have too much trouble making judgements on the number of degrees of freedom based on physical insight and the issue should not be overemphasized. Some textbooks count equations and variables to establish the number of degrees of freedom. However, a better approach is to establish the degrees of freedoms first from physical insight and then possibly do the counting afterwards to make sure one has not missed some equations.

2.2 The conservation principle

The basis for most dynamic models is the principle of conservation. For mass this simply says

The rate of change of mass within a specified region of space (control volume), equals the rate of which mass enters that region, minus the rate at which mass leaves.

Identical statements may be made for other conserved quantities such as component mass or mole (provided chemical reactions are taken properly into account), energy, momentum (mv) and electric charge. The last two are not considered any further in this paper. It should be noted right away that enthalpy is not a conserved quantity except in the special case of constant pressure and volume, for liquids (only approximately), or if we consider steady state.

In mathematical terms consider the quantity S which may be mass, m , moles of component A, n_A , or energy, E . Let c denote the concentration of S per unit volume and consider a control volume with volume $V(m^3)$. For example c may represent density, $\rho(kg/m^3)$, concentration of component A, $c_A(moleA/m^3)$, or specific energy, $e(J/m^3)$. The conservation principle for change in S per unit of time is

$$\frac{d}{dt} \text{Holdup} = \text{Bulk}_{in} - \text{Bulk}_{out} + \text{Supply of } S \text{ by other means} + R \quad (1)$$

where $\text{Holdup} = cV$ is the holdup of quantity S , $\text{Bulk}_{in} = c_{in}q_{in}$ is the amount of S entering the control volume per time unit through bulk (convective) transport, $\text{Bulk}_{out} = c_{out}q_{out}$ is the amount leaving with bulk transport, q denotes flow in m^3/s , supply of S by other means includes for example diffusion of mass through a membrane, external work and heat transfer through a wall, $R = rV$ is the rate of formation of S by chemical reaction,

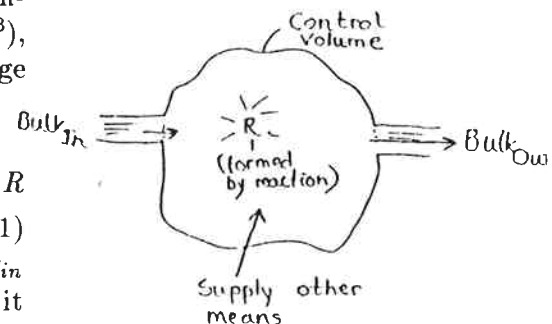

and r is the specific reaction rate (amount of $S/m^3 s$).

Applications to small (differential) control volumes give rise to partial differential equations. In specific applications one may choose to use other units for V and q than those given above, but the basic principle is still the same.

2.3 Flash tank case study

As a simple example consider the flash tank in Fig. 1 with external heating and no chemical reaction. This example will provide a good basis for further studies on distillation dynamics. Three valves are shown in Fig. 1: one each for heat input Q , liquid outflow B , and vapor outflow D . These are all potentially independent variables. However, in some cases we may rely on self-regulation for liquid holdup (level) or vapor holdup (pressure) in which case B or D becomes a dependent variable instead. In other cases we have a control system in place; this also may change independent variables into dependent variables. Also note that at steady-state the holdups have to be constant and there is only one independent variable.

We shall use moles as our basis. We now apply the conservation principle to the tank.

i) Total material balance (mol/s)

$$\frac{d}{dt}(M_L + M_V) = F - B - D \quad (2)$$

where M_L M_V are liquid and vapor holdups in mol, and F , B and D are flows in mol/s.

ii) Material balance of light component (mol/s)

$$\frac{d}{dt}(M_L x + M_V y) = Fz - Bx - Dy \quad (3)$$

iii) Energy balance (J/s)

$$\frac{d\text{Energy}}{dt} = (\text{Energy In} - \text{Energy Out})_{\text{Bulk}} + \text{Work} + Q \quad (4)$$

where "energy" in a stream means internal energy u . "Work" is the work done on the control volume by streams entering and exiting the system. For example, the energy entering with the feed stream is Fu_F and the pV -work done on the system by this stream is Fp_F/ρ_F . The total contribution of energy and work from the feed stream is then $F(u_F + p_F/\rho_F) = Fh_F$, that is, enthalpy appears as the sum of (internal) energy and work. The energy balance then becomes

$$\frac{d(M_L u_L + M_V u_V)}{dt} = Fh_F - Bh_L - Dh_V + Q \quad (5)$$

where the (in this case saturation) energies u and h are known functions of composition and temperature T . Note that internal energy and not enthalpy appears on the left hand side.

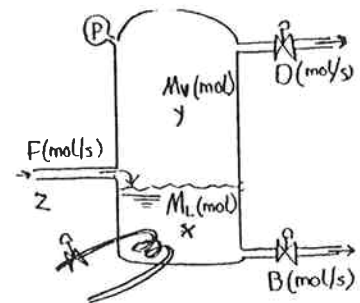

Fig.1

Comment on reference energy: Energy needs always be defined relative to some reference state, and the value of e.g. h_F will depend on this choice. Typical reference states for energy include: 1) Pure components as saturated liquids at some given pressure (i.e., each component has a different reference temperature; this reference state is often used for distillation models), 2) Pure components as liquid at a given temperature and pressure, e.g., 0°C and 1 atm (used in some commercial simulators such as PROCESS), 3) Pure components as ideal gas at 298.15 K and 1 atm (often used if equations of state are used), 4) Elements as ideal gas or solid at 298.15 K and 1 atm (makes it easy to care of chemical reactions without having to add a separate heat of reaction term).

In the following we shall assume

A1 Perfect mixing in both phases

A2 Thermodynamic equilibrium between phases

and consider two special cases: Case A: Composition response with constant pressure and holdup. Case B: Pressure (temperature) response with 1-component mixture.

Flash tank: Composition response.

The problem in this case is to find how the compositions vary with time. Consider a binary mixtures and let x and y represent the mole fraction of light component in the two phases. The assumption of VLE yields

$$y = Kx \quad (6)$$

where the equilibrium “constant” $K(x, p)$ in general is a complex function of composition and pressure. For the special case of *constant relative volatility*, α , we have

$$K(x, p) = K(x) = \frac{\alpha}{1 + (\alpha - 1)x}$$

We now make the following physical (engineering) assumptions

A3 Constant liquid holdup M_L

A4 Constant vapor holdup M_V

Vapor and liquid holdups are assumed constant and since these cannot be truly independent variables physically, we are implicitly assuming that there is a “perfect” control system in place. This control system (Fig. 2) may use, for example, the heat input Q and the liquid outflow B to keep constant pressure and level (these variables are closely related to M_V and M_L). In this case D becomes the only independent variable while Q and B become dependent variables. Such assumptions about

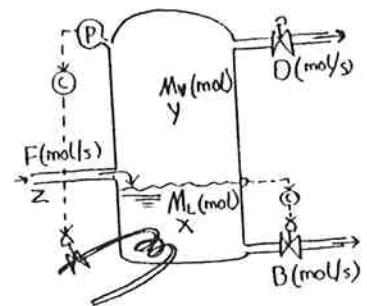

Fig. 2

“perfect inventory control” is frequently used and may reduce the modelling effort.

With the above assumptions the total material balance becomes

$$B = F - D \quad (7)$$

Substitute (6) and (7) into the component balance (3) and set dM_V/dt and dM_L/dt equal to zero. This gives

$$M_L \frac{dx}{dt} + M_V \frac{d(K(x)x)}{dt} = Fz - (F - D)x - DK(x)x \quad (8)$$

Eq.8 yields an equation for how x varies with time with D and the feed (F, z) as independent variables. It is a simple nonlinear first order differential equation which may easily be solved. Note that with D as the independent variable the energy balance does not yield any additional information. However, it could have been used to compute the necessary heat input Q .

Assume the feed (F, z) is constant. A linear model useful for obtaining insight and possibly for control purposes is easily derived.

$$(M_L + M_V K') \frac{d\Delta x}{dt} = -(B^* + D^* K') \Delta x - (y^* - x^*) \Delta D \quad (9)$$

where $K' = (\partial y / \partial x)^* = (\partial(K(x)x) / \partial x)^*$ is the slope of VLE-curve at the nominal steady-state. Δ denotes deviations from the nominal steady-state (which is denoted with superscript $*$). By “nominal” we mean the initial steady-state value at time $t = 0$. For example, $\Delta D(t) = D(t) - D^*$, and we have $\Delta(0) = 0$. To simplify notation the superscript $*$ and also the explicit time dependence (t) is deleted in the remainder of the paper (except in cases where it is needed for clarification). Written in terms of Laplace transforms (essentially, replace differentiation by the Laplace operator s) the linear model becomes

$$\Delta x(s) = g(s) \Delta D(s); \quad g(s) = \frac{k_x}{\tau_x s + 1} \quad (10)$$

where the “steady-state gain” (the value of the transfer function $g(s)$ when $s = 0$) is

$$k_x = -\frac{y - x}{B + DK'} \quad (11)$$

and the linear time constant for the response is

$$\tau_x = (M_L + M_V K') / (B + DK') \quad (12)$$

The initial slope of the response, that is, the value of $dx(t)/dt$ just after $t = 0$ (may obtain from $sg(s)$ by letting $s \rightarrow \infty$) becomes

$$k'_x = \frac{k_x}{\tau_x} = -\frac{y - x}{M_L + M_V K'}$$

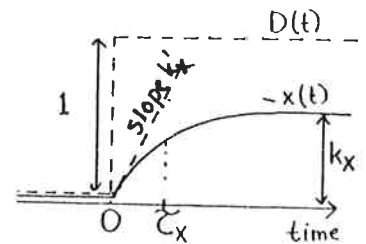
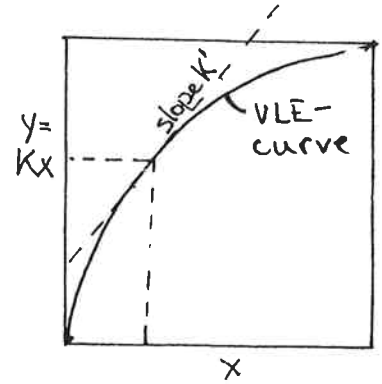

Fig. 3

In many cases K' will be of the order 1 and the gain k_x will be approximately $-(y - x)/F$ and the time constant τ_x will be approximately $(M_L + M_V)/F$ which is the residence time of the tank. In words, for the case of negligible M_V , the time constant is equal to the liquid holdup divided by the sum of liquid outflow plus K' times vapor outflow. We shall make use of this result later when studying distillation columns. In the derivation above we assumed F and z_F constant. However, it is easily shown that the same value of the time constant also applies to changes in F and z_F . We can show that the same time constant applies also when M_V and M_L vary with time, provided we neglect the direct effect of changes in x on M_L and M_V .

Flash tank: Pressure (temperature) response

In this case we make the following assumptions

A3 Constant liquid holdup M_L

A4 Volume of vapor V_V constant

A5 One-component mixture

For a one-component mixture the assumption of vapor-liquid equilibrium gives that the pressure p must equal the saturation pressure for the component

$$p = p^{sat}(T) \quad (13)$$

Consequently, specifying the tank pressure is equivalent to specifying its temperature T . Furthermore, because V_V is constant, M_V is directly related to T (using an equation of state).

Also in this case we have made the "perfect control" assumption of constant M_L . Assume that B is used to keep level (i.e., M_L) constant. In addition to the feed the independent variables are then D and Q . Given these independent variables we may obtain the dependent variables T (temperature) and B as functions of time using Equations 14 and 15.

Since $dM_L/dt = 0$ the material balance becomes (mol/s)

$$\frac{dM_V}{dt} = F - B - D \quad (14)$$

The energy balance yields

$$M_L \frac{du_L}{dt} + \frac{d(M_V u_V)}{dt} = F h_F - B h_L - D h_V + Q \quad (15)$$

Numerical solution and the index problem. The model above (Eq. 14 and 15) is perfectly sound, yet many numerical software packages will not be able to solve it. The reason is that we have what is called an index problem (of order 2). Index problems arise in general whenever the equations involve differentiation of

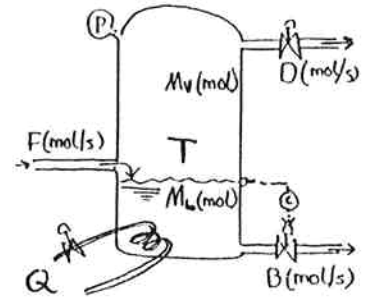

a variable which is not a state variable. States of a dynamical system are the minimum number of variables that must be specified at $t = 0$ (in addition to the independent variables such as feed, Q and B above) in order to be able to solve the equations for $t > 0$. In the present problem there is only one state variable, which may be chosen to be the holdup M_V (or equivalently p or T which are directly related to M_V).

Now imagine that a standard differential equation solver (for example, using Euler integration) is used to solve the equations. At a given time step the state variable M_V (and consequently p and T) is known, and the user has to supply the value of dM_V/dt at this time step. This derivative is given by Eq.14, but first the liquid outflow B , which is an dependent variable, must be obtained. B may be found from Eq.15, but this requires that the time derivative of the energy in the tank is known. In theory, Eq.15 may be transferred into a purely algebraic equation which is easily solvable for B (as shown below for a specific case), but in practice it may be extremely tedious and not worthwhile. For example, the term $du_L/dt \approx dh_L/dt$ which appears on the left hand side of Eq.15 may be written as

$$\frac{dh_L}{dt} = \frac{\partial h_L}{\partial M_V} \frac{dM_V}{dt} \quad (16)$$

and we may substitute in for dM_V/dt from the material balance and transfer Eq.15 to an algebraic equation. However, evaluating the term

$$\frac{\partial h_L}{\partial M_V} = \frac{\partial h_L}{\partial T} \left(\frac{\partial T}{\partial p} \right)^{sat} \frac{\partial p}{\partial M_V} \quad (17)$$

requires analytical expression for derivatives of the enthalpy equations, the saturation pressure equation and the equation of state. In general, these may be extremely tedious to obtain, in particular for multicomponent mixtures. Numerical differentiation may be used, but again this will be very time consuming because it involves differentiation of all the thermodynamic equations which themselves often are iterative calculations. A simpler solution, which actually is implemented for a similar problem in our multicomponent dynamic distillation program (ddlp) at Institutt for Kjemiteknikk, is to evaluate dh_L/dt using data for *previous* time steps, that is

$$\frac{dh_L}{dt} \approx \frac{h_L(t) - h_L(t + \Delta t)}{\Delta t} \quad (18)$$

This gives very good results since the contribution to to the energy balance from the change in enthalpy with time usually is very small.

Although the index problem is really a numerical problem and not a modelling problem, it is important also for the modeller to be aware of it. It may be avoided in some cases by rewriting the model. In the present case the index problem may be removed

by *not* assuming M_L constant, and introducing $B = f(M_L)$ (the function f may represent a self-regulating effect or a controller). The material and energy balance give expressions for the time derivatives of total mass $M = M_L + M_V$ and total energy $U = M_L u_L + M_V u_V$ and M and U may be used as states. At a given time step, M and U are known. A constant volume (tank volume) and constant internal energy flash will yield the phase distribution (M_V and M_L) and the pressure/temperature. One should note that this may not be an easy task, because the kind of flash here required may be time consuming and is not available in many thermodynamic packages. The derivatives of M and U may subsequently be calculated.

Flash tank: Pressure response. Analytical expressions for insight. We shall now linearize the equations to gain insight into what response times we might expect. Make the following additional assumptions

A6 Ideal gas equation of state:

$$p = M_V RT/V_V \quad (19)$$

A7 Specific energy (J/mol) is a function of temperature only, that is, $du = c_V dT$ and $dh = c_P dT$.

A8 Liquid: $u_L \approx h_L$; Vapor: $u_V \approx h_V - RT$ (ideal gas).

In particular, the simple equation of state and the fact that $p = p^{sat}(T)$ makes it possible to evaluate terms such as $\partial h_L / \partial M_V$ analytically (recall Eq. 17) and thus avoids the index problem.

As reference state for energy we choose to use the pure liquid as saturated liquid at the nominal pressure, i.e., $h_L^* = 0$ (this is simply a convenient choice, and not really an assumption). We also introduce the heat of vaporization $h^{vap} = h_V - h_L$.

To study the pressure response we consider the energy balance, Eq.15.

$$M_L \frac{du_L}{dt} + M_V \frac{du_V}{dt} + u_V \frac{dM_V}{dt} = Fh_F - Bh_L - Dh_V + Q \quad (20)$$

Consider the effect of a change in D (with B as a dependent variable). Linearize for the case with Fh_F and Q constant and introduce assumptions A7 and A8 and $h_L^* = 0$ to obtain

$$\begin{aligned} (M_L c_{V_L} + M_V c_{V_V}) \frac{d\Delta T}{dt} + \hat{h}^{vap} \frac{dM_V}{dt} &= -B\Delta h_L - h^{vap}\Delta D - D\Delta h_V \\ &= -h^{vap}\Delta D - (Bc_{P_L} + Dc_{P_V})\Delta T \end{aligned} \quad (21)$$

where $\hat{h}^{vap} = u_V - h_L = h^{vap} - RT$ (in most cases we may set $\hat{h}^{vap} \approx h^{vap}$). As noted previously there is a direct relation

between M_V and T given by the equations $M_V = pV_V/RT$ and $p = p^{sat}(T)$. Combining these algebraic (static) equations yields

$$\begin{aligned}\Delta M_V &= \frac{V_V}{RT} \frac{dp^{sat}}{dT} \Delta T - \frac{pV_V}{RT^2} \Delta T \\ &= M_V \left(\frac{d \ln p^{sat}}{d \ln T} - 1 \right) \frac{1}{T} \Delta T = M_V \frac{K^{sat}}{T} \Delta T \quad (22)\end{aligned}$$

The term $K^{sat} = \left(\frac{d \ln p^{sat}}{d \ln T} - 1 \right)$ is typically of the order 8^2 . Introducing (22) into (21) and taking the Laplace transforms finally yields (this expression also applies to the pressure response since $\Delta p = \frac{RT}{V_V} (1 + \frac{1}{K^{sat}} \Delta M_V)$)

$$\Delta M_V(s) = \frac{k'}{s + 1/\tau_p} \Delta D(s) \quad (23)$$

where the initial gain is

$$k' = - \frac{M_V h^{vap} K^{sat} / T}{M_L c_{V_L} + M_V c_{V_V} + M_V \hat{h}^{vap} K^{sat} / T} \quad (24)$$

and the time constant for "self-regulation" of vapor holdup (pressure) is

$$\tau_p = \frac{M_L c_{V_L} + M_V c_{V_V} + M_V \hat{h}^{vap} K^{sat} / T}{B c_{P_L} + D c_{P_V}} \quad (25)$$

The steady-state gain is $k = k' \tau_p = - \frac{M_V h^{vap} K^{sat} / T}{B c_{P_L} + D c_{P_V}}$. The term "self-regulation" refers to the fact that after an increase in the exiting vapor flow, D , the vapor holdup will level off at a lower value. In the case with no self-regulation we would simply have $\Delta M_V(s) = -(1/s) \Delta D(s)^3$, and the holdup would decrease continuously with a constant slope of -1 (i.e., $k' = -1$ and $\tau_p = \infty$ and $k = -\infty$). However, in practice the decrease in M_V (and thereby in pressure) leads to vaporization of liquid which counteracts the increase in D . In the new steady-state there is a balance between the additional "latent" enthalpy leaving with the vapor, and the reduced "thermal" energy, and we have $B c_{P_L} \Delta T + D c_{P_V} \Delta T = h^{vap} \Delta D$.

In the case of negligible vapor holdup, k' will be close to zero and τ_p will be of the order of the residence time, M_L/F

²This value may be obtained using

$$\frac{\partial \ln p^{sat}}{\partial \ln T} \approx \frac{h^{vap}}{RT} \approx 6.5 z^{vap} \frac{T_c}{T}$$

(see RPS, Ch.6) where z^{vap} is the difference in compressibility between the vapor and liquid phase. At the normal boiling point (1 atm) we have $z^{vap} \approx 1$ and $T_c/T = T_c/T_b \approx 1.4$.

³To derive this consider the material balance, Eq.2, and assume M_L , F and B are constant as may be reasonable for a flash tank where no condensation/evaporation takes place, i.e., h^{vap} is very large

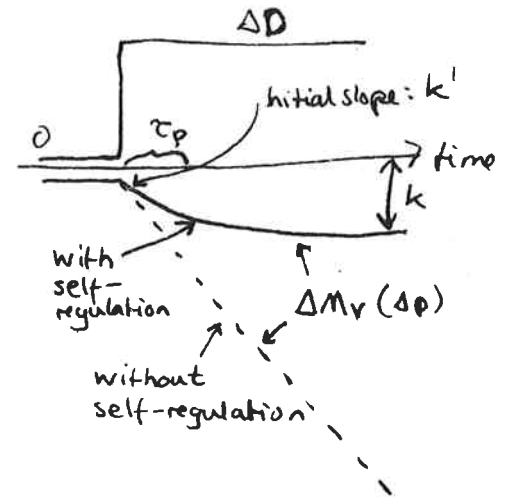
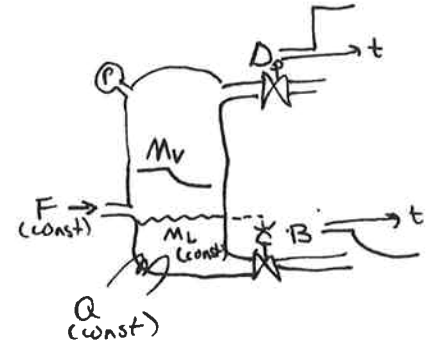

(somewhat higher since in general $c_{PV} > c_{PL}$). If the vapor holdup is "large", then k' is close to -1 and τ_p is of the order $\frac{M_V h^{vap} K^{sat}}{F c_{PL} T}$, which typically is of the order $4M_V/F$.

The value of the time constant for pressure will be the same if we consider other changes such as in F and Q provided no other "self-regulating" effects take place. However, the gain will obviously be different in such cases.

Comment: A common assumption is to neglect changes in internal energy, that is, to set the left hand side of the energy balance (Eq.20) equal to zero. Note that since the left hand side contains the term $u_V^* dM_V/dt$ and since dM_V/dt is not negligible, this assumption in our case only makes sense if we at the same time choose the reference state for energy such that $u_V^* = 0$. With this assumption $h_L^* = -\hat{h}^{vap}$ and the energy balance simply becomes $0 = -\hat{h}^{vap} \Delta B + (Bc_{PL} + Dc_{PV}) \Delta T + RT \Delta D$ and we obtain by combining with the material balance $k' = -1 - RT/\hat{h}^{vap} \approx -1$ and $\tau_p = \frac{M_V \hat{h}^{vap} K^{sat}/T}{Bc_{PL} + Dc_{PV}}$. These values are approximately the same as found above for the case with M_V large (However, note that the steady-state gain $k = k' \tau_p$ is close to the correct value). Thus, neglecting energy changes is often a poor assumption even with the reference state chosen such that the term $u dM/dt$ is zero. This makes sense, since the "self-regulating" effect on pressure caused by the liquid phase is due to the change in temperature which is neglected if h_L is assumed constant.

Extensions. If heat transfer to the tank internals (walls etc.) is included, then the time constant will increase, and the total heat capacity of these (in J/K) must be included in the numerator of Eq.25. Above that heat input Q was assumed constant. We have thus neglected the possible effect temperature might have on heat input Q , for example, we might have $Q = UA(T_h - T)$. Such an effect would decrease the time constant and a term $\partial Q/\partial T = UA$ should be added to the denominator of Eq.25.

Note that although the time constant above was derived for a one-component mixture, it will also apply to close-boiling mixtures where temperature is mainly a function of pressure such that the assumption $p = p^{sat}(T)$ applies.

Distillation columns: Pressure response. The analysis for the flash tank above will apply to the self-regulation of pressure in a distillation column if we make balances over the entire column and assume 1) Physical data such as c_P , h^{vap} and K^{sat} are constant throughout the column, 2) the temperature change ΔT (and thereby Δp) is the same throughout the column, and 3) the flows leaving and entering the column are at their saturation temperatures. By the "column" we mean the column section without condenser and reboiler. D and B then represent the net flows leaving the column in the top and bottom, respectively. If the pressure change is caused by an increase in V_T (or decrease in

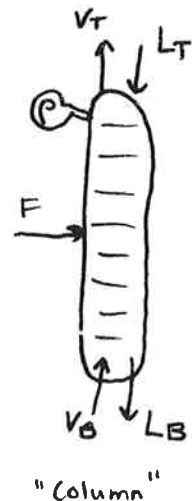

V) then the gain k' is identical to the one derived before (Eq.24) except that the two first terms in the denominator are replaced by C_V . C_V represents the total heat capacity (J/K) for the entire column including liquid, vapor and column internals (this assumes that heat transfer is immediate; C_V should be reduced if heat transfer to column internals is slow). The time constant becomes (feed liquid)

$$\tau_p = \frac{C_V + M_V \hat{h}^{vap} K^{sat}/T}{F c_{PL} + \partial Q_C/\partial T + \partial Q_R/\partial T} \quad (26)$$

The term $F c_{PL}$ in the denominator is an approximation for $L_B c_{PLB} - I_T c_{PLT} + V_T c_{PV_T} - V_B c_{PV_B}$ which applies to the case with constant c_{PV} and c_{PL} , feed liquid and constant molar flows ($V_T = V_B$). The last two terms in the denominator account for the possible effect of temperature on V_T and V_B caused by changes in condenser and reboiler duty (which both may decrease if T increases and thus reduce τ_p). Note that these terms usually will dominate in the denominator if either one is present. A typical value for these terms will be $\partial Q/\partial T = Q/\Delta T_Q = h^{vap} V/\Delta T_Q$ where V is the boilup and ΔT_Q is the temperature difference between the hot and cold side (typically 30 K). Whether these terms are present or not depends on the nature of heating and cooling. In many cases the heat input to the reboiler Q_R is supplied by condensing steam and Q_R is almost independent of the temperature in the column, that is, $\partial Q_R/\partial T \approx 0$. If both of these terms are zero, that is, $\partial Q_C/\partial T$ is also zero, then τ_p may be large. This does not mean that self-regulation of pressure can be neglected since the magnitude of the gain k' is significantly less than 1 when M_V is small.

Typical values for holdups: Total liquid holdup on the trays inside the column, $M_I/F = 0.5N$ [min] where N is the number of trays in the column. Total vapor holdup,

$$M_V/F = 0.001h[m]\sqrt{p[bar]M[kg/m^3]}V/F \quad [\text{min}]$$

(assuming vapor velocity about half of flooding velocity; h is the column height).

Numerical example: Consider an example where we neglect storage of thermal energy in the column internals and in the liquid in the reboiler and condenser. Assume $M_I/F = 20$ min and $M_V/F = 0.7$ min (Use $N = 40$, 1 m average tray spacing incl. top and bottom part of column, $V/F = 3$, $p = 1$ bar, $M = 30\text{kg/m}^3$). Furthermore assume $T = 400\text{K}$, $h^{vap} = 31$ kJ/mol (i.e., $\hat{h}^{vap} = 27.6$ kJ/mol), $c_{PL} = 163$ J/mol K, $c_{PV} = 131$ J/mol K (i.e., $c_{V_V} = 123$ J/mol K), and $K^{sat} \alpha = 8$. Neglect self-regulation in the reboiler and assume that the temperature difference between hot and cold side in the condenser, ΔT_C , is 30 K. We get

$$\tau_p = \frac{M_I c_{V_L} + M_V c_{V_V} + M_V \hat{h}^{vap} K^{sat}/T}{F c_{PL} + V h^{vap}/\Delta T_C} \quad (27)$$

$$\begin{aligned}
&= \frac{20 \cdot 0.16 + 0.7 \cdot 0.12 + 0.7 \cdot 27.6 \cdot 8/400}{0.16 + 3 \cdot 31/30} \\
&= \frac{3.2 + 0.09 + 0.39}{0.16 + 3.1} = 1.1 \text{min} \quad (28)
\end{aligned}$$

Note that the contribution from the vapor phase is about 10% of that of the liquid phase. The term Fc_{P_L} in the denominator is usually negligible provided we have self-regulation in the condenser, and τ_p becomes relatively small. On the other hand, if these effects are negligible then a lower bound on τ_p becomes $\tau_p > M_I/F$, which usually is quite large.

The initial gain is independent of the effects in the condenser and reboiler. We get

$$\begin{aligned}
k' &= -\frac{M_V h^{vap} K^{sat}/T}{M_L c_{V_L} + M_V c_{V_V} + M_V \hat{h}^{vap} K^{sat}/T} \\
&= -\frac{0.43}{3.26 + 0.09 + 0.39} = -0.12 \quad (29)
\end{aligned}$$

which is significantly less than -1. Thus, self-regulation of pressure will be important in distillation columns, except in cases with large vapor holdup (pressure larger than 20 bar). Physically, for an increase in boilup, the self-regulation is caused by condensing vapor which increases the temperature to match the higher pressure.

Summary. For a multicomponent flash tank with varying pressure, the model will be a combination of the composition and pressure responses studied above. However, for close-boiling mixtures the temperature will mainly be a function of pressure and the equations derived above for τ_p will apply. Also, in this case compositions are not very much affected by pressure and the expression derived for τ_x applies.

Several things are probably clear from the examples above: 1) Even for this simple example there are a number of possibilities with respect to modelling assumptions and simplifications. 2) Very interesting results may be obtained simply by applying the conservation principle for mass and energy. 3) Linearizing the equations may yield invaluable insight in terms of analytical expressions for the time constants. Such insights may be very difficult to obtain from simulation studies using the nonlinear equations.

3 Modelling of Distillation Columns

3.1 Introduction

A distillation column consists of a large number of flash tanks of the kind studied above stacked on top of each other, and the insight obtained above will prove useful.

This part is mainly taken from two papers by Skogestad and Morari (1987,1988) and also from the Diploma thesis by Jacobsen (1987). The main emphasis here is on the *composition* response and we shall assume negligible vapor holdup, constant pressure (the pressure dynamics were considered above) and constant molar flows. However, let us first consider a more general model.

3.2 General model

Consider a tray i that is not a feed tray, and which does not have any product streams or heat input/output. On each tray a differential equation may be formulated for ,

(ii) the overall material balance (flow dynamics)

$$\frac{d}{dt}M_i = L_{i+1} + V_{i-1} - L_i - V_i \quad (30)$$

$$\text{where } M_i = M_{L_i} + M_{V_i}$$

$$\text{(tray hydraulics) } L_i = f_1(V_i, M_{L_i}, \Delta p_i)$$

$$\text{(pressure drop) } V_i = f_2(M_{L_i}, \Delta p_i)$$

(i) the material balance for each component (composition dynamics)

$$\frac{dn_i}{dt} = L_{i+1}x_{i+1} + V_{i-1}y_{i-1} - L_ix_i - V_iy_i \quad (31)$$

$$\text{where : } n_i = M_{L_i}x_i + M_{V_i}y_i$$

and (iii) the energy balance

$$\frac{dU_i}{dt} = L_{i+1}h_{L,i+1} + V_{i-1}h_{V,i-1} - L_ih_{L_i} - V_ih_{V_i} \quad (32)$$

$$\text{where } U_i = M_i u_i = M_{L_i}u_{L_i} + M_{V_i}u_{V_i}$$

The vapor and liquid phase on a tray are assumed to be in thermodynamic equilibrium, and a separate set of (algebraic) thermodynamic equations give the remaining necessary relationships.

Rigorous approach. This set of equations may be solved as follows: State variables is the n_i for each component (sum of which is M_i) and U_i (a total of $N(N_c + 1)$ state variables where N is the number of stages and N_c the number of components). When performing the integration the values of these variables are known at each time step. Procedure: 1) Given the mole numbers n_i , the internal energy U_i and the total tray volume. 2) Perform a UV-flash for each tray. This yields the phase split (M_{L_i}, M_{V_i}) , the phase compositions (x_i, y_i) , the temperature (T_i) and pressure (p_i) , and the specific energies (h_{L_i}, h_{V_i}) . 3) L_i and V_i may now be computed from the algebraic expressions for tray hydraulics and pressure drop. All the variables on the right hand side of Equations 31-32 above are now known and the derivatives of the state variables may be computed and the integration may proceed.

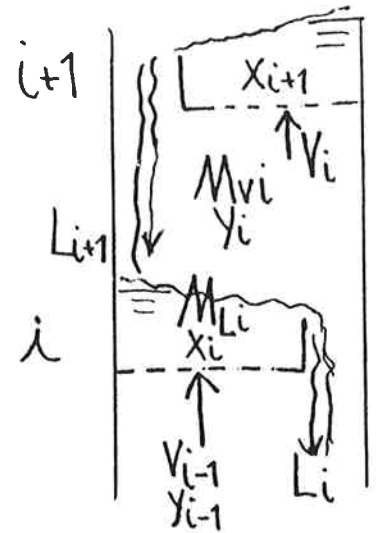

3.3 Simplified models

1. *Neglecting vapor holdup.* Very few dynamic distillation programs solve the equations in this rigorous fashion. In most cases the holdup in the vapor phase is neglected, that is, n_i is replaced by $M_{Li}x_i$ and M_i is replaced by M_{Li} . The balance equations become

$$i) \quad \frac{d}{dt}M_{Li} = L_{i+1} + V_{i-1} - L_i - V_i \quad (33)$$

$$ii) \quad \frac{d(M_{Li}x_i)}{dt} = L_{i+1}x_{i+1} + V_{i-1}y_{i-1} - L_ix_i - V_iy_i \quad (34)$$

$$iii) \quad \frac{d(M_{Li}h_{Li})}{dt} = L_{i+1}h_{L,i+1} + V_{i-1}h_{V,i-1} - L_ih_{Li} - V_ih_{Vi} \quad (35)$$

Note that we have one state less on each tray in this case (the total number of states is NN_c), but the number of differential equations remains the same - this signals an "index problem" (see Gritsis et al, 1988). Choose the state variables as x_i and M_{Li} . The solution (integration) of the equations may proceed as follows: 1) At a given time step, pressure is assumed to be known (either assumed constant, or guessed from previous time steps). 2) With given x_i and p_i a bubble point flash is performed to compute y_i , T_i and the specific enthalpies. 3) We now want to use the energy balance (35) to compute V_i . This gives rise to an index problem as discussed in the previous section, but it may be circumvented by estimating dh_{Li}/dt using previous time steps as shown in Eq.18. 4) Since V_i is now known, pressure may be computed from the pressure drop equation (One might possibly redo the steps above if the initial guess for the pressure was wrong). L_i is finally computed from the tray hydraulics, and the derivatives of the state equations may now be computed.

Note that the simple bubble point flash is much simpler to handle for most thermodynamic packages than the flash with constant energy and volume required by the rigorous approach. However, we have to pay for it in terms of the index problem. Furthermore, the assumption of negligible vapor holdup is not appropriate when the pressure is large. The above model also implies that a change in vapor flow at the bottom of the column *immediately* will change the vapor flow at the top. This is of course somewhat unrealistic, and is caused by the fact that we have neglected the vapor holdup.

2. *Assuming equal vapor flows up the column ("constant molar flows").* In addition to neglecting the the vapor holdup, neglect changes in specific enthalpy on the tray (that is, neglect the term $M_{Li}dh_{Li}/dt$)⁴. Substitute dM_{Li}/dt from the total material

⁴The assumption of constant h_{Li} on a given tray i is reasonable if: 1) The reference state for enthalpy is pure component as saturated liquid at column pressure (this means that the individual components have different reference

balance (33) into the energy balance (35) and derive

$$0 = L_{i+1}(h_{L,i+1} - h_{Li}) + V_{i-1}(h_{V,i-1} - h_{Li}) - V_i(h_{Vi} - h_{Li}) \quad (36)$$

This is in fact identical to the steady-state enthalpy balance. The “constant molar flows” assumption (as used in steady-state distillation) implies that we assume h_{Li} constant and equal on all trays (as discussed in the footnote) and assume constant heat of vaporization, h^{vap} , throughout the column (ie., all pure components have the same heat of vaporization at the column pressure). Then (36) yields $0 = (V_{i-1} - V_i)h^{vap}$ and we have

$$V_i(t) = V_{i-1}(t) \quad (37)$$

That is, the vapor flow up the column is equal on all trays (except at locations where there is a feed stream). At steady state the liquid flows will also be equal down the column, that is $L_i^* = L_{i+1}^*$, but dynamically these will not be equal because the holdup M_{Li} varies. This means that if L at the top of the column changes then it will take some time before liquid flow further down the column changes.

Decoupling of liquid flow dynamics. One important implication of the above equal vapor flow assumption, is that the liquid flow dynamics become completely decoupled from the composition dynamics. The total material balance becomes

$$\frac{dM_{Li}}{dt} = L_{i+1} - L_i \quad (38)$$

where L_i is a function of M_{Li} and V_i (tray hydraulics). This set of equations may be used to find the dynamic response L_i on a given tray as a function of changes in reflux and boilup without considering the composition response. The detailed equations for the linearized case are presented in Appendix B.

3. *Neglecting liquid flow dynamics.* On the other hand, the composition dynamics (Eq.34), will depend on the liquid flow dynamics, Eq.38. However, the dependency is usually weak and as a first assumption one may assume immediate liquid flow responses when considering the composition response. In particular, it may be shown that the eigenvalues (ie., time constants) for the composition dynamics are independent of the flow dynamics if constant molar flows are assumed. This follows since the overall state matrix is triangular because the compositions x_i have no effect on the holdup M_{Li} in this case. The simplified model presented next for the composition response neglects the flow dynamics.

temperatures); 2) Column pressure is constant; 3) Negligible heat of mixing. With these assumptions we get $h_{Li} = 0$ on all trays and there is no “cooling” effect of sending additional cold liquid down the column.

3.4 Simplified model for composition dynamics

We shall illustrate the modelling and simulation of distillation column using a simple column with only three stages. Assume constant vapor holdup (pressure), constant holdup of liquid (that is, neglect flow dynamics), negligible vapor holdup, perfect control of levels using D and B , constant molar flows, binary separation, vapor-liquid equilibrium on all trays, and constant relative volatility for the VLE. With these assumptions the only states are the mole fraction x_i on each tray. The complete model for a column with N theoretical trays is given in Appendix A.

Example 2. Three-stage column.

Problem statement.

The column has two theoretical stages plus a total condenser. Stage 1 is the total condenser, the liquid feed enters on stage 2, and stage 3 is the reboiler (For convenience the numbering has been reversed compared to the rest of the paper). Steady state column data are as follows:

$$F=1 \text{ kmol/min, } z_F=0.5$$

$$D=0.5 \text{ kmol/min, } y_D = x_1 = 0.9$$

$$B=0.5 \text{ kmol/min, } x_B = x_3 = 0.1$$

$$\text{Relative volatility, } \alpha = 10.0$$

$$\text{Tray holdup (incl. reboiler and condenser), } M_i = 1 \text{ kmol}$$

Here x, y, z represent mole fractions of the most volatile component. With these data the steady-state column profile becomes

Table 1:

Stage	i	L_i	V_i	x_i	y_i
Condenser	1	3.05		0.9000	
Feedstage	2	4.05	3.55	0.4737	0.9000
Reboiler	3		3.55	0.1000	0.5263

a) Formulate the dynamic equations for the composition response with L and V as independent variables (in addition to F and z).

b) Linearize the equation and write them on the form $dx/dt = A\Delta x + B\Delta u + E\Delta f$ where $\Delta x, \Delta u$ and Δf are deviation variables. The three elements in the vector x are the mole fractions x_i on each stage, the two elements in u are reflux ($L = L_1$) and boilup ($V = V_3$), and the two elements in f (disturbances) are feed flow (F) and feed composition (z_F). The linearized VLE on

⁵Note that the tray numbering in this example (starting from the top) is opposite of what was used above (starting from the bottom). The use of numbering starting from the top is convenient when representing the data on matrix form (since the 1st row is on the top) and has gained popularity lately

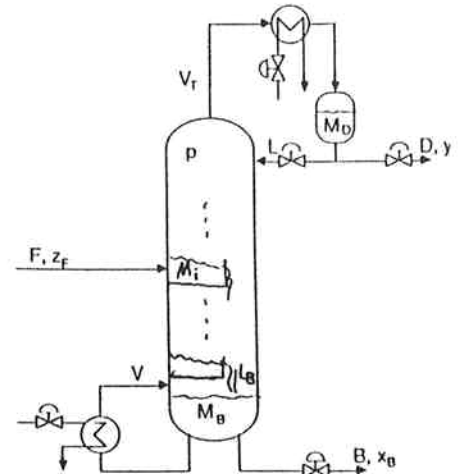

each tray is written $dy_i/dx_i = k^{-i}$. Compute the eigenvalues of the matrix A .

c) Simulate the response to a disturbance in feed composition from 0.50 to 0.51 with the other independent variables constant. What is the dominating time constant of the response?

Solution.

a) The material balance for light component on each tray gives:

$$M_1 \frac{dx_1}{dt} = V_2 y_2 - L_1 x_1 - D x_1 \quad (39)$$

$$M_2 \frac{dx_2}{dt} = F z_F + V_3 y_3 + L_1 x_1 - V_2 y_2 - L_2 x_2 \quad (40)$$

$$M_3 \frac{dx_3}{dt} = L_2 x_2 - V_3 y_3 - B x_3 \quad (41)$$

With the assumptions above the flow responses are decoupled from the composition dynamics and we have at any given time:

$$V_2 = V, \quad L_2 = L + F, \quad D = V - L, \quad B = L + F - V \quad (42)$$

(the last two equations follow because D and B are used for level control).

b) Linearizing the material balance for the condenser (stage 1) yields

$$M_1 \frac{dx_1}{dt} = V(\Delta y_2 - \Delta x_1) + (y_2 - x_1)\Delta V \quad (43)$$

Here the last term is zero because $y_2 = x_1$ at steady-state for a total condenser. The component balances for the other stages may be linearized in similar manner and we obtain the linear model

$$M_i \frac{dx}{dt} = A \Delta x + B \Delta u + E \Delta f \quad (44)$$

$$x = \begin{pmatrix} x_1 \\ x_2 \\ x_3 \end{pmatrix}; \quad u = \begin{pmatrix} L \\ V \end{pmatrix}; \quad f = \begin{pmatrix} F \\ z_F \end{pmatrix} \quad (45)$$

where

$$A = \begin{pmatrix} -V & VK'_2 & 0 \\ L & -(L+F+VK'_2) & VK'_3 \\ 0 & L+F & -(BVK'_3) \end{pmatrix} = \begin{pmatrix} -3.550 & 1.282 & 0 \\ 3.050 & -5.332 & 9.834 \\ 0 & 4.050 & -10.334 \end{pmatrix}$$

$$B = \begin{pmatrix} 0 & 0 \\ x_1 - x_2 & y_3 - y_2 \\ x_2 - x_3 & -(y_3 - x_3) \end{pmatrix} = \begin{pmatrix} 0 & 0 \\ 0.4263 & -0.3737 \\ 0.3737 & -0.4263 \end{pmatrix}$$

$$E = \begin{pmatrix} 0 & 0 \\ z_F - x_2 & F \\ x_2 - x_3 & 0 \end{pmatrix} = \begin{pmatrix} 0 & 0 \\ 0.0263 & 1 \\ 0.3737 & 0 \end{pmatrix}$$

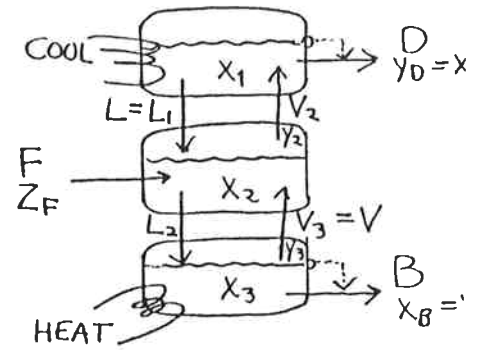

Three stage column

Here K'_i are the linearized equilibrium constant which for the case of constant relative volatility becomes $K'_i = \alpha / (1 + (\alpha - 1)x_i)^2$ and we have $K'_2 = 0.361, K'_3 = 2.770$. The eigenvalues of the state matrix A are $-0.22, -4.26$ and -14.7 (min^{-1}). The dominant time constant is expected to be equal to the inverse of the smallest eigenvalue, that is, equal to $1/0.22 = 4.5$ min.

Note that all the elements in the first row of B and E are all zero. This implies the changes in L, V, F or z_F have no immediate effect on top composition. The reason is of course that $x_1 = y_2$ at steady-state because of the total condenser. However, this does not mean that the steady-state effect is zero because of the interactions with the other stages. Indeed, the steady-state gain matrix G which gives the effect of L, V, F, z_F on x_1, x_2, x_3 is given by

$$G = -A^{-1}[B \quad E] = \begin{pmatrix} 0.750 & -0.748 & 0.366 & 0.959 \\ 2.08 & -2.07 & 1.01 & 2.65 \\ 0.850 & -0.853 & 0.433 & 1.04 \end{pmatrix} \quad (46)$$

c) Nonlinear simulations of an increase of z_F of 0.01 using the program MATLAB are shown in Fig. 4. We note that the dominant time constant is about 4.5 min as expected from the linear analysis. Also note, for example, that the steady-state increase in x_2 is about 0.026, which corresponds to a gain of $0.026/0.01 = 2.6$. This compares nicely with the value 2.65 in the gain matrix G .

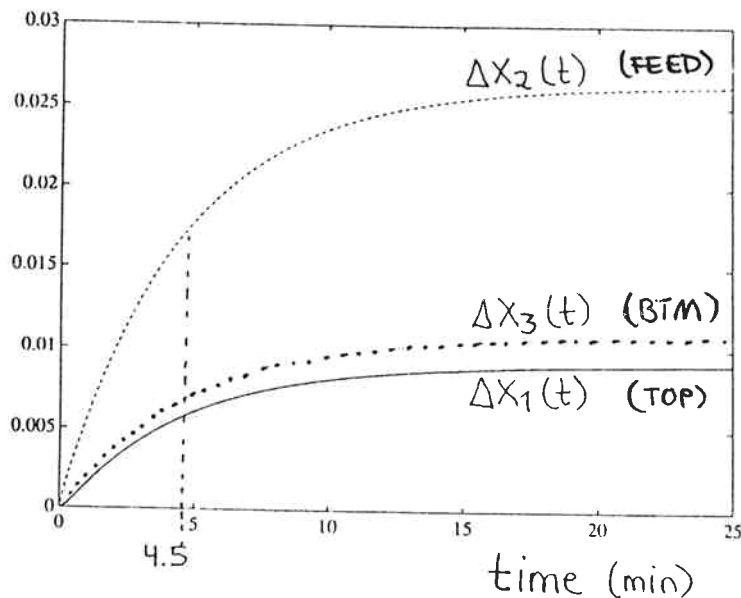

matlab call:

$[t, x] = \text{ode45}('dist', 0.25, [0.9; 0.4737; 0.1], 1.e-6, 1)$ x at $t=0$

dist.m : (matlab subroutine)

function yprime=dist(t,x);

a=10;
y(1)=x(1);
y(2)=a*x(2)/(1+(a-1)*x(2));
y(3)=a*x(3)/(1+(a-1)*x(3));

l1 = 3.05;
l2 = 4.05;
v2 = 3.55;
v3 = 3.55;
b = 0.5;
d = 0.5;
f = 1;
zf = 0.51;

Step in z_F
from 0.50 to 0.51

dx1dt = v2*y(2) - l1*x(1) - d*x(1);
dx2dt = f*zf + v3*y(3) + l1*x(1) - v2*y(2) - l2*x(2);
dx3dt = l2*x(2) - v3*y(3) - b*x(3);

yprime=[dx1dt;dx2dt;dx3dt];

Fig.4. Response for 3-stage column to feed composition change.

4 Analysis of the dynamic behavior of distillation columns

For a column with N stages we get N coupled differential equations for the compositions (x_i) only. From this one might expect that distillation columns have a complex and high-order dynamic response. However, both observations and simulations have established that the dynamic composition response in a distillation column is dominated by one large time constant, τ_1 , which is nearly the same regardless of where a disturbance is introduced or where composition is measured.

The objective of this Chapter is to explain this somewhat unexpected behavior and gain insight into the dynamic behavior of the column. As before this is done by developing a simple linear model of the column with analytical expressions for the time constants and gains.

One possibility for deriving such a model would be to linearize all the equations. However, because of the large number of trays (and equations) this would result in a high-order model (at least of order N) which hardly would be very helpful for gaining insight. It would of course be possible to reduce the number of states by using established methods for model reduction (Balanced realization, residualization, mode matching, etc.), but these methods are purely numerical and we would not obtain any analytical expressions which would yield insight. In fact, it would not yield any more insight than simulations with the nonlinear model.

Attempt 1. As a first guess we might try to simply add together the time constants of the individual trays. Recall Eq.12 where we showed that the composition response for an individual tray is $\tau_{xi} = M_i / (L_i + K'_i V_i)$. For a composition change to travel from the top to the bottom (or the opposite) the overall lag will be $\tau_{xM} = \sum \tau_{xi}$. Consider the 3-stage column in Example 2. The individual composition time constants on the stages are (recall Eq.12): $\tau_{x1} = \frac{M_1}{L_1 + D} = 0.282$ min, $\tau_{x2} = \frac{M_2}{L_2 + K'_2 V_2} = 0.171$ min, $\tau_{x3} = \frac{M_3}{B + K'_3 V_3} = 0.097$ min, and we find that the sum is $\tau_{xM} = 0.55$ min. However, this is much smaller than the observed dominant time constant of 4.5 min. Consequently, this simplistic approach does not work.

Attempt 2. A second simple approach is simply to use the total holdup. We get $M_I / F = 3$ min, which is closer to the observed value, but is still too small. The reason is that the compositions change more in the middle of the column than towards the column ends.

Attempt 3. An alternative approach is to consider the total holdup of each component in the column and assume that all trays have the same response. As we shall show below this di-

rectly leads to a first order model, and the dominant time constant can be estimated very accurately. According to Rademaker et al. (1975, p.280) this idea dates back to the beginning of the century (Lord Raleigh) and seems to get rediscovered every few years.

Derivation of expression for τ_1

Consider a column which initially ($t = 0$) is at steady state (subscript 0). At $t = 0$ a step change is introduced to the column which eventually ($t \rightarrow \infty$) moves the column to a new steady state (subscript f). The nature of this step change is not important as long as i) the new steady state is known and ii) it leads to a change in the total holdup in the column of one or more component. This includes most disturbances and inputs except changes in the internal flows (simultaneous changes in L and V keeping product rates constant).

Assumption 1. *The flow dynamics are immediate, i.e., for $t > 0$: $M_i(t) = M_{if}$, $D(t) = D_f$, $B(t) = B_f$.*

The assumption is reasonable when considering the composition dynamics, provided the flow response is much faster than the composition response. Using Assumption 1 the overall material balance for any component for $t > 0$ becomes:

$$\frac{d}{dt} \left[\sum_{i=1}^{N+1} M_{if} x_i(t) \right] = F_f z_{Ff} - D_f y_D(t) - B_f x_B(t) \quad (47)$$

Subtracting the final steady state

$$0 = F_f z_{Ff} - D_f y_{Df} - B_f x_{Bf} \quad (48)$$

yields

$$\sum_{i=1}^{N+1} M_{if} \frac{d\Delta x_i(t)}{dt} = -D_f \Delta y_D(t) - B_f \Delta x_B(t) \quad (49)$$

where Δ represents the deviation from the final steady-state, eg., $\Delta y_D(t) = y_D(t) - y_{Df}$.

Assumption 2. *All trays have the same dynamic responses, that is: $\Delta x_i(t) = \Delta x_i k(t)$, $\Delta y_D(t) = \Delta y_D k(t)$, $\Delta x_B(t) = \Delta x_B k(t)$. (Here $k(0) = 1$ and $\Delta x_i = \Delta x_i(0)$, $\Delta y_D = \Delta y_D(0)$ and $\Delta x_B = \Delta x_B(0)$ denote the difference between the initial and final steady state.)*

This assumption is reasonable if the time constant for the internal mixing in the column, τ_{xM} , introduced above, is much shorter than the dominant time constant. τ_{xM} is the time it takes for a composition change to travel from the top to bottom, and is typically is of the order $M_I/(L + V)$. Assumption 2 and Eq.(49) yield

$$\left(\sum_{i=1}^{N+1} M_{if} \Delta x_i \right) \frac{dk(t)}{dt} = (-D_f \Delta y_D - B_f \Delta x_B) k(t) \quad (50)$$

Solving (50) gives a linear first-order response

$$k(t) = e^{-t/\tau_1} \quad (51)$$

where the time constant τ_1 is:

$$\tau_1 = \frac{\sum_{i=1}^{N+1} M_{if} \Delta x_i}{\Delta S_i} \quad (52)$$

ΔS_i is the supply imbalance

$$\Delta S_i = D_f \Delta y_D + B_f \Delta x_B = \Delta(Fz_f) - y_{D0} \Delta D - x_{B0} \Delta B \quad (53)$$

A simple interpretation of (52) is

$$\tau_1 = \frac{\text{"change in holdup of one component" (kmol)}}{\text{"imbalance in supply of this component" (kmol/min)}}$$

Comments on (52):

1. The column model was not linearized, and (52) applies to any finite change provided Assumptions 1 and 2 hold.
2. The time constant depends on the magnitude and "direction" (negative or positive change) of the step change introduced.
3. The expression for τ_1 applies to any component in a multicomponent mixture.
4. Eq. (52) applies to any change which changes the external material balance, i.e., which has $\Delta S_i \neq 0$. Eq. (52) does not apply for changes in the internal flows (changing L and V while keeping D and B constant) because the denominator ΔS_i is zero in this case (see (53)). Methods for estimating the time constant for changes in the internal flows are discussed in another paper (Skogestad and Morari, 1987).
5. To compute τ_1 according to (52) a steady-state model of the column is needed. For obtaining accurate numerical values a nonlinear simulation program should be used. Such programs are usually readily available to the engineer. For any given step change two simulations is all what is needed to compute τ_1 .
6. Very large time constants are found for small perturbations to columns with both products of high purity. This agrees numerous observations from simulations. The reason is that the compositions inside the column may change significantly (the entire column profile may shift resulting in a large change in component holdup), while the change in product compositions may be very small (resulting in a small imbalance ΔS_i to cause the change in component holdup).
7. One disadvantage of (52) is that the compositions on all trays are needed to compute τ_1 . However, Skogestad and Morari (1987) have derived an analytical expression which is valid for high-purity binary separations and *small* perturbations to the column which requires much less data.

$$\tau_{1sc} \approx \frac{M_I}{\ln S \cdot I_s} + \frac{M_D y_D (1 - y_D)}{I_s} + \frac{M_B x_B (1 - x_B)}{I_s} \quad (54)$$

where

$$S = \frac{y_D(1-x_B)}{(1-y_D)x_B}; \quad I_s = Bx_B(1-x_B) + Dy_D(1-y_D) \quad (55)$$

Here M_I is the total holdup inside the column, M_D and M_B are the condenser and reboiler holdups and S is the separation factor. The first term in (54), which represents the contribution from changing the component holdup inside the column, dominates for columns with both products of high purity ($1-y_D$ and x_B both small). Note that I_s may be extremely small in such cases resulting in very large values of $\tau_{1,sc}$. The reader is encouraged to study the paper by Skogestad and Morari (1987) who discuss the use of (52) and (54) in detail.

Example 2 (continued). Three-stage Column.

To illustrate the usefulness of the above methods consider the simple three stage column studied before. The following steady-state profiles are obtained when z_F is increased from 0.50 to 0.51 with all flows constant:

Table 2:

Stage	i	L_i	V_i	x_i	y_i
Condenser	1	3.05		0.9091	
Feedstage	2	4.05	3.55	0.5001	0.9091
Reboiler	3		3.55	0.1109	0.5549

Problem statement: a) Use these steady-state profiles to estimate the dominant time constant. b) Compare with the shortcut formula. c) Comment on the validity of these methods for estimating τ_1 .

Solution. a) From the steady-state profiles in Tables 1 and 2 and Eq.52:

$$\begin{aligned} \tau_1 &= \frac{\sum_{i=1}^{N+1} M_{if} \Delta x_i}{\Delta(Fz_F) - y_D \Delta D - x_B \Delta B} \quad (56) \\ &= \frac{1 \cdot 0.0091 + 1 \cdot 0.0264 + 1 \cdot 0.0109}{0.01 - 0 - 0} = 4.64 \text{min} \end{aligned}$$

b) From the shortcut formula (54) using data from Table 1 (and $x_B = 1 - y_D$):

$$\tau_{1,sc} = \frac{M_I/F}{x_B y_D \ln S} + \frac{M_D}{F} + \frac{M_B}{F} = \frac{1}{0.1 \cdot 0.9 \cdot 4.39} + 1 + 1 = 4.53 \text{min} \quad (57)$$

c) Discussion. First we note an excellent agreement between these estimates and the values obtained from the nonlinear simulations and from the eigenvalues of the state matrix. The main assumption behind the formulas used above for estimating τ_1 is that all trays have the same composition response. This seems reasonable for such a small column with a large reflux ratio, and

is also confirmed by considering the time constant for internal mixing, τ_{xM} , which we found to be 0.55 min. This is much less than 4.5 min and Assumption 2 is valid.

5 Distillation column model for control purposes

The presence of the large dominant time constant has led many operators and engineers to believe that distillation columns cannot be easily controlled (“they are so slow so it takes hours before anything happens”). However, this is not true because feedback control changes the flows to the column in a different manner, and we can get response times much shorter than the dominant time constant (for example, in the order of minutes provided the measurement delays are not too large).

Furthermore, although the dominant time constant is actually observed in real columns, it appears not too be very important for control purposes. The reason is of course that the dominant time constant is often much larger than the response time which we want under feedback control. These issues are discussed in a number of other papers (Skogestad and Morari, 1988, Skogestad et al., 1990). For example, under feedback control the response of the *internal flows* proves to be much more important than in open-loop operation, because the feedback excites this direction to a much larger degree. Also, as mentioned in the Introduction, the initial response is critical for feedback control. This implies that flow dynamics, valve dynamics, measurement dynamics are very important, and in fact much more important than the dominant dynamics expressed by the dominant time constant.

A simple linear low-order linear model appropriate for control purposes have been presented by Skogestad and Morari (1988, Section 9) and the reader is referred to this paper for further details.

NOMENCLATURE

$I_s = Dy_D(1 - y_D) + Bx_B(1 - x_B)$ - “impurity sum”

$K = y/x$ - vapor-liquid equilibrium “constant”

$K' = \partial y / \partial x$ - slope of vapor-liquid equilibrium line

$L = L_T$ - reflux flow rate (kmol/min)

L_B - liquid flow rate into reboiler (kmol/min)

M_i - liquid holdup on tray no. i (kmol)

$M_I = \sum_i M_i$ - total liquid holdup inside column (kmol)

N - number of trays in column q_F - fraction liquid in feed

$S = \frac{y_D(1-x_B)}{(1-y_D)x_B}$ - separation factor

$V = V_B$ - boilup from reboiler (kmol/min)

V_T - vapor flow rate on top tray (kmol/min)

x_B - mole fraction of light component in bottom product

y_D - mole fraction of light component in distillate (top product)
 z_F - mole fraction of light component in feed

Greek symbols

$\alpha = \frac{y_i/x_i}{(1-y_i)/(1-x_i)}$ - relative volatility for binary mixture

τ_1 - dominant time constant for external flows (min)

τ_2 - time constant for internal flows (min)

$\tau_L = (\partial M_i / \partial L)_V$ - hydraulic time constant (min)

$\theta_L = (N - 1)\tau_L$ - overall lag for liquid response (min)

REFERENCES

Billet, R.; M. Schultes, "Determination of Liquid Hold-up in Gas-Liquid Two-Phase Countercurrent Mass Transfer Columns", Conf. Distillation 87, Published In *I. Chem. E. Symposium Series*, 1987, **104**, A159-A170.

Denn, M., "Process Modelling", Pitman Publishing Inc., 1986.

Gritsis, D.; C.C. Pantelidid; R.W.H. Sargent, "The dynamic simulation of transient systems described by index two differential-algebraic equations", Presented at PSE 88 Conference, Sydney, Aug. 1988.

Rademaker, O., J. E. Rijnsdorp; A. Maarleveld, "Dynamics and Control of Continuous Distillation Units"; Elsevier: Amsterdam, 1975.

Rijnsdorp, J. E., "Interaction in Two-Variable Control Systems for Distillation Columns - I", *Automatica*, 1965, **1**, 15-28.

Shinskey, F. G., "Distillation Control", 2nd Edition; McGraw-Hill: New York, 1984.

Skogestad, S.; M. Morari, "The Dominant Time Constant for Distillation Columns", *Comp. & Chem. Engng.*, 1987, **11**, 6, 607-617.

Skogestad, S. and M. Morari, 1988, "Understanding the Dynamic Behavior of Distillation Columns", *Ind.Eng.Chem.Res.*, **27**, 10, 1848-1862.

APPENDIX A. Simplified distillation column model for compositions.

The model presented below neglects the flow dynamics. The liquid flow dynamics are presented separately in Appendix B.

Assumptions:

- N theoretical stages plus total condenser, binary separation, constant molar flows, constant relative volatility α
- Vapor-Liquid Equilibrium (VLE) and perfect mixing on all stages
- No vapor holdup (i.e., immediate vapor response, $dV_T = dV_B$)
- Liquid holdup M_i on all trays constant (i.e., immediate liquid response, $dL_B = dL_T$)

This yields a $(N+1)$ 'th order model with one ordinary differential equation on each tray ($i = 1, N + 1$).

Nonlinear model

Material balances for change in holdup of light component on each tray:

$i = 2, N$ ($i \neq N_F, i \neq N_F + 1$):

$$M_i \dot{x}_i = L_{i+1}x_{i+1} + V_{i-1}y_{i-1} - L_i x_i - V_i y_i$$

Above feed location, $i = N_F + 1$:

$$M_i \dot{x}_i = L_{i+1}x_{i+1} + V_{i-1}y_{i-1} - L_i x_i - V_i y_i + F_V y_F$$

Below feed location, $i = N_F$:

$$M_i \dot{x}_i = L_{i+1}x_{i+1} + V_{i-1}y_{i-1} - L_i x_i - V_i y_i + F_L x_F$$

Reboiler, $i = 1$:

$$M_B \dot{x}_i = L_{i+1}x_{i+1} - V_i y_i - B x_i, \quad x_B = x_1$$

Total condenser, $i = N + 1$:

$$M_D \dot{x}_i = V_{i-1}y_{i-1} - L_i x_i - D x_i, \quad y_D = x_{N+1}$$

VLE on each tray ($i = 1, N$), constant relative volatility:

$$y_i = \frac{\alpha x_i}{1 + (\alpha - 1)x_i}$$

Flow rates assuming constant molar flows:

$$i > N_F \text{ (above feed): } \quad L_i = L, \quad V_i = V + F_V$$

$$i \leq N_F \text{ (below feed): } \quad L_i = L + F_L, \quad V_i = V$$

$$F_L = q_F F, \quad F_V = F - F_L$$

$$D = V_N - L = V + F_V - L \quad (\text{condenser holdup constant})$$

$$B = L_2 - V_1 = L + F_L - V \quad (\text{reboiler holdup constant})$$

Compositions x_F and y_F in the liquid and vapor phase of the feed are obtained by solving the flash equations:

$$F z_F = F_L x_F + F_V y_F$$

$$y_F = \frac{\alpha x_F}{1 + (\alpha - 1)x_F}$$

Linear model

Linearized material balance on each tray ($dL_i = dL$, $dV_i = dV$):

$$M_i \dot{x}_i = L_{i+1} dx_{i+1} - (L_i + K'_i V_i) dx_i + K'_{i-1} V_{i-1} dx_{i-1} + (x_{i+1} - x_i) dL - (y_i - y_{i-1}) dV$$

where K'_i is the linearized VLE-constant:

$$K'_i = \frac{dy_i}{dx_i} = \frac{\alpha}{(1 + (\alpha - 1)x_i)^2}$$

and y_i, x_i, L_i and V_i are the steady-state values at the nominal operating point. Written in the standard state variable form in terms of deviation variables:

$$\dot{x} = Ax + Bu, \quad y = Cx$$

Here $x = (dx_1, \dots, dx_{N+1})^T$ are the tray compositions, $u = (dL, dV)^T$ are the manipulated inputs and $y = (dy_D, dx_B)^T$ are the controlled outputs. The state matrix $A = \{a_{i,j}\}$ is tri-diagonal:

$$\begin{aligned} i \neq N + 1 : \quad a_{i,i+1} &= L_{i+1}/M_i \\ & a_{i,i} = -(L_i + K'_i V_i)/M_i \\ i \neq 1 : \quad a_{i,i-1} &= K'_{i-1} V_{i-1}/M_i \end{aligned}$$

Input matrix $B = \{b_{i,j}\}$:

$$\begin{aligned} i \neq N+1: \quad b_{i,1} &= (x_{i+1} - x_i)/M_i, \quad b_{N+1,1} = 0 \\ i \neq 1, i \neq N+1: \quad b_{i,2} &= -(y_i - y_{i-1})/M_i, \\ b_{N+1,2} &= 0, \quad b_{1,2} = (y_1 - x_1)/M_1 \end{aligned}$$

Output matrix C :

$$C = \begin{pmatrix} 0 & 0 & \dots & 0 & 1 \\ 1 & 0 & \dots & 0 & 0 \end{pmatrix}$$

APPENDIX B. Simplified model for liquid flow dynamics.

With the assumption of constant molar flows and negligible vapor holdup the liquid flow dynamics are decoupled from the composition response. The material balance for liquid holdup becomes

$$\frac{dM_{Li}}{dt} = L_{i+1} - L_i \quad (58)$$

Use the following linearized tray hydraulics

$$L_i = L_i^* + \left(\frac{\partial L_i}{\partial V}\right)_{M_i} \Delta V + \left(\frac{\partial L_i}{\partial M_i}\right)_V \Delta M_i \quad (59)$$

$$\stackrel{\text{def}}{=} L_i^* + \lambda \Delta V + \frac{1}{\tau_L} \Delta M_i \quad (60)$$

Consider the response of the liquid flow at the bottom of the column, L_B , to changes in reflux, L , and boilup, V . Repeated combination of Eq.58 and 60 for a column with N_T trays yields (Rademaker et al., 1975)

$$\Delta L_B = g_L(s) \Delta L(s) + \lambda(1 - g_L(s)) \Delta V(s) \quad (61)$$

$$\text{where } g_L(s) = \frac{1}{(1 + \tau_L s)^{N_T}} \approx e^{-\theta_L s} \quad (62)$$

and $\theta_L = N_T \tau_L$. The approximation on the right hand side of (62) follows since the response of N_T identical lags may be approximated well by a dead time equal to the sum of the lags when N_T is large. The values for θ_L and λ should preferably be determined experimentally: θ_L is the time it takes for an increase in reflux to affect the reboiler level; λ may be obtained by observing the response in reboiler level to a change in boilup. The effect of nonzero λ 's was first discussed by Rijnsdorp (1965) and is often denoted the K_2 -effect because he used this symbol for λ .

Tray columns. A typical value for the liquid holdup on each tray is $M_i/F = 0.5$ min. Let $M_i = M_{ui} + M_{oi}$ where M_{oi} represent the amount of liquid over the weir. According to the Francis weir formula $M_{oi} = k_1 L_i^{2/3}$ and we derive

$$\tau_L = \left(\frac{\partial M_i}{\partial L_i}\right)_V = \left(\frac{\partial M_{oi}}{\partial L_i}\right)_V = \frac{2}{3} \frac{M_{oi}}{L} \quad (65)$$

Assuming all trays are identical, this yields the following value for θ_L

$$\theta_L = N_T \tau_L = \frac{2}{3} \frac{M_{oi}}{M_i} \frac{M_I}{L} \quad (66)$$

where M_I is the total holdup inside the column. A typical value is $M_{oi}/M_i \approx 0.5$.

Physically λ represents the initial change (M_i constant) in liquid flow on each tray caused by a change in boilup. For most trayed columns λ is positive, but it may also be negative in some cases. A negative λ may be caused by "build-up" of liquid in the downcomer due to increased pressure drop over the tray. A positive λ may be caused by vapor "pushing" liquid off the trays due to an increase of gas bubbles in the liquid. For $\lambda > 0.5$ both x_B and the reboiler level will show an inverse response for an increase in boilup (Rademaker et al., 1975). Such behavior can be detrimental for control purposes.

Packed Columns. Eq. (61)-(62) apply also to packed columns. The total liquid holdup inside the column (M_I) can be estimated for various packings from published correlations (eg., Billet and Schultes (1987)). M_I increases with liquid load. We have $M_I = k_2 \cdot L^n$ where n is typically about 0.6 (Billet and Schultes). This yields

$$\theta_L = n \frac{M_I}{L}, \quad n \approx 0.6 \quad (67)$$

At low vapor flow rates the liquid holdup is nearly independent of V , ie., $\lambda = 0$. This applies up to the loading point where liquid entrainment becomes important, and we have $\lambda < 0$. Since λ is always negative for packed columns we do not expect inverse response for changes in boilup.

Tray versus Packed Columns. Packed columns usually have smaller liquid holdups inside the column than do trayed columns. This results in a faster dynamic response for packed columns, but it also makes flow and level responses more important. Firstly, the smaller holdup inside the column makes the condenser and reboiler holdups more important for packed columns. Secondly, the relative importance of the flow response compared to the composition response inside the column is about twice as large for a packed column. The reason is that whereas the entire liquid phase always contributes in the composition response, it is only the liquid above the weir (M_{oi}) that contributes to the flow response in a trayed column. This effect may be beneficial for control purposes as it decouples the column ends more in terms of their composition response.