

## Voltage Rise Issue with High Penetration of Grid Connected PV

Ainah Priye Kenneth\*. Komla Folly\*\*

\* *Department of Electrical Engineering, University of Cape Town, South Africa  
(Tel: +27743370780, Email: anhpri001@myuct.ac.za)*

\*\* *Department of Electrical Engineering, University of Cape Town, South Africa  
(Email: komla.folly@uct.ac.za)*

---

Abstract: High penetration of Photovoltaic distributed generators (PV-DG) on the low voltage (LV) grid is as a result of the deregulation of the electricity market and increasing environmental issues related to global warming arising from the use of fossil fuel power plants. The penetration of PV systems on LV grid is seen as a viable option to fossil fuel power plants and it is gaining popularity globally. The PV technology is in a period of rapid expansion and is increasingly becoming important in the electricity market due to their ability to carry out stand-alone power, grid support and greenhouse gases reduction. However, the proliferation of PV on LV grid has raised concern to distribution network operators (DNO) due to the negative impact of high penetration level of PV. The negative impact are protection issues, increased losses, transformer and cable rating issues, sudden voltage rise and reverse power flow which has affected the behavior of the traditional LV grid. The negative impact of high PV penetration has affected the operation of on load tap changers (OLTC) and automatic voltage regulation; therefore, there is a need to incorporate communication with PV and voltage control devices to curtail the voltage rise issues. This paper discusses the issue of sudden voltage rise and reverse power flow resulting from high penetration of PV on LV grid and also the need for a smarter grid.

---

### 1. INTRODUCTION

In the last decade, the use of renewable energy has significantly grown due to the global concern on climate change, increase in electrical power demand and liberalization of the electricity market. The quest for a friendlier environment and the need to reduce the emission of greenhouse gases led to the signing of the Kyoto protocol in Kyoto, Japan in December 1997. This agreement has made countries to invest in renewable energy to reduce CO<sub>2</sub> emission. Renewable energy technologies and their application into the electric power system are seen as a solution to the reduction of CO<sub>2</sub> emission globally due to the fact that these renewable energy technologies are non-pollutant. This advantage has led to the introduction of distributed generator based renewable and non-renewable energy systems into the low voltage network. Traditionally, low voltage distribution networks are defined in a radial fashion and are for one way power flow that is from a high voltage sub-station to low voltage customer loads. Voltage settings at the secondary side of the controllable transformer before the load are usually set at +/- (5–10) % greater than the customer end-use voltage to accommodate the distribution network line losses. The violation of this limit undermined the security of the network. In order to keep the voltage at the distribution level within statutory limits, traditional on load tap changer transformers (OLTC) coupled with the automatic voltage regulator (AVR) relays regulates the transformer output voltage to keep the voltage magnitude within limits (Tengku T. H et al, 2012). The introduction of distributed generator (DG) distorts this order with issue of sudden voltage rise and reverse power flow. Distribution generation (DG) also known as embedded generation is

defined as the connection of electrical power source directly into the distribution network or on the customer side of the meter (Thomas A. et al, 2001). Due to global concern on green-house gases and a friendlier environment, renewable energy technologies are more admirable because they are pollution free. As the world moves toward a low carbon economy, renewable energy sources of energy are becoming increasingly attractive for industrial and domestic applications (Matthew O. et al, 2013). The well-known form of renewable energy technologies are wind, solar (photovoltaic (PV) system), small hydro plant, fuel cell, wave technology etc. Out of which, solar (PV system) seems to be more promising because its primary resource is everywhere and in varying intensity globally. The solar power radiated from the sun and received by earth's atmosphere is about 86000TW (AminMohammed. S et al, 2013) and the utilisation of this enormous energy can be economically viable and its application will be environmentally friendly. PV technology has grown in the last decade because of its ability to carry out stand-alone power, grid support and greenhouse gases reduction. Today, most integration of PV systems on the power system network is predominantly seen on the low voltage distribution network. These power grids will still experience more penetration by customers, small scale generation industries and utility operators in the nearest future due to government subsidies and falling price of photovoltaic panels. Incentive scheme is also one of the driving forces to the increasing use and development of this technology. The most common incentive mechanisms used in Europe are feed-in tariffs and quota systems. The feed-in tariffs energy strategy is now practiced in about 50 countries in the last decade (REN 21, 2011). According to (Smainverter, 2012), 29GW of PV is installed in Germany

which is over five percent of the electricity consumption in the first half of 2012. Out of which 80 percent of the installed PV systems are connected to the low voltage grid. With the feed in tariff strategy, UK experienced high installed solar power from 26MW before the scheme started at the beginning of April 2010 to 77MW at the end of November 2011, with an increase of 196% (Ali. S et al, 2012). In 2011, Italy also connected about 9GW of PV power with an impressive 290% increase from 2010 (Cracium. B-L, et al, 2012). The integration of photovoltaic (PV) is seen to bring both technological and environment benefits to the traditional distribution networks under liberalized market structure (Sarika. K. S et al, 2012, Pepermans. G, et al, 2005). However, high integration bring some negative impact on the system such as voltage rise, reverse power flow, transformer and cable rating, increase power losses, voltage unbalance, on line tap changers (OLTC) and automatic voltage regulator (AVR) (Aguero. R. J and Steffel. J. S, 2011). The negative impact of PV systems tends to affect the operation, control and security of the traditional distribution feeder. The low voltage grid is not design with the anticipation of integration of external power sources like PV systems which have undermined the behaviour of the network. The impact of high PV penetration on low voltage grid has led to a call for a self-healing grid (smart grid) to curtail the negative issues associated PV penetration using a combination of communication, mitigation measures and control technologies. The aim of this paper is to give an overview of some of the impact of high penetration of PV and the need for a smarter grid to help mitigate some of the challenges caused by PV.

## 2. ON LOAD TAP CHANGER (OLTC) AND AUTOMATIC VOLTAGE REGULATOR (AVR) RELAY

Voltage level is an essential parameter for the control of electrical power networks and it is the responsibility of the distribution network operators (DNO) to maintain the supplied voltage within acceptable range at the load side of the network. (Gao. C and Redfern. M. A, 2010). Traditional voltage control methods are normally through the use of transformer on load tap changer (OLTC) at transmission or at the medium voltage substations or automatic voltage regulators (AVR) relay. OLTC mechanism is a transformer component controlled automatically by a relay to increase or decrease voltage by altering the tap position of transformers (Tengku T. H et al, 2012). The function of the automatic voltage regulator (AVR) is to measure the voltage and current (VVT and ICT) at the load side of the transformer and then compare the measured voltage with the pre-determine voltage (reference or setting voltage value) of AVR ( $V_{ref}$ ). The difference is then compared with the tolerance setting of the AVR and if it exceeds this setting, a tap change is initiated to adjust the transformer voltage at the load side to a satisfactory level (Hiscock. N. et al, 2008). Figure 1; describe the basic operation of OLTC and a simple AVR relay.

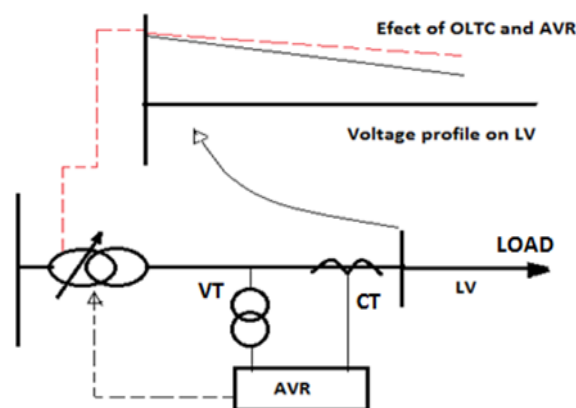

Figure 1: Basic operation of OLTC and AVR Relay

The AVR relay ensures that the voltage at a local or remote location is controlled within the set limits (Madzonga. L.S, et al, 2009). As the penetration of PV system on the low voltage network increase, the AVR operation becomes complicated and ineffective due to the reverse power flow accompany with high current and voltage on the network. The negative impact of PV system on low voltage network has led to the development of different voltage mitigation measures in recent years. The mitigation measures will be discussed briefly in this paper

## 3. EFFECT OF PV INTEGRATION ON A LV GRID

Distribution networks are designed in such way that power will flow from the medium voltage (MV) network to the low voltage (LV) networks (Pathomthat. C et al, 2004) but the new trend of integrating high PV system on distribution network can undermined the behaviour of the traditional distribution feeder. This means that the voltage at the load end will be greater than the feeder supply voltage. The unprecedented behaviour of the feeder due to impact of PV systems has drawn keen interest from researchers around the world and it has resulted in the development of analytical tools for investigating these impacts so as to develop mitigation measures to curb some of the issues and challenges on distribution feeders. The negative impacts have been studied using different software techniques and methods (Alam. M. J. E, et al, 2012; Barry. A, 2012; Carlos. G et al, 2012; Lewis. S. J, 2011; Mesut. E. B, et al, 2012; Alex. G. Et al, 2012; Dhavalkumar. P. Et al, 2011; Deema. A and Vinod. K, 2011). The next section investigates the impact of high penetration of PV on low voltage distribution grid (LV) using Digsilent powerfactory software.(Digsilent powerfactory, 2013)

### 3.1 Negative Impact Investigation of High PV Integration on a LV Grid

A simplified 16 bus low voltage radial network with 270kW of PV systems installed within the network will be used to examine the potential impact on how high PV can perturb the assumptions on the operation of the traditional low voltage network. The network is model with a lumped peak load of 26.4 KVA at a power factor of 0.95 at the end of the feeder, a low voltage distribution transformer (75KVA, 20 kV/0.4 kV), line impedance of  $1.652+j1.2$  ohm/km, fourteen five kW

photovoltaic system distributed on the feeder (14, 5kW, PV) and a feeder length of 1.4 km with a distance of 100m between terminal. The PV inverter is assumed to operate at unity power factor. See network in figure 2. In the low voltage network different load flow with different penetration of PV were carried out to ascertain the negative impact on the

network. To understand the behaviour of the network, the penetration level of PV was set to over 900%. The bold black mark on the buses reveals the impact of voltage rise while the grey mark on the transformer indicates the impact on transformer loading.

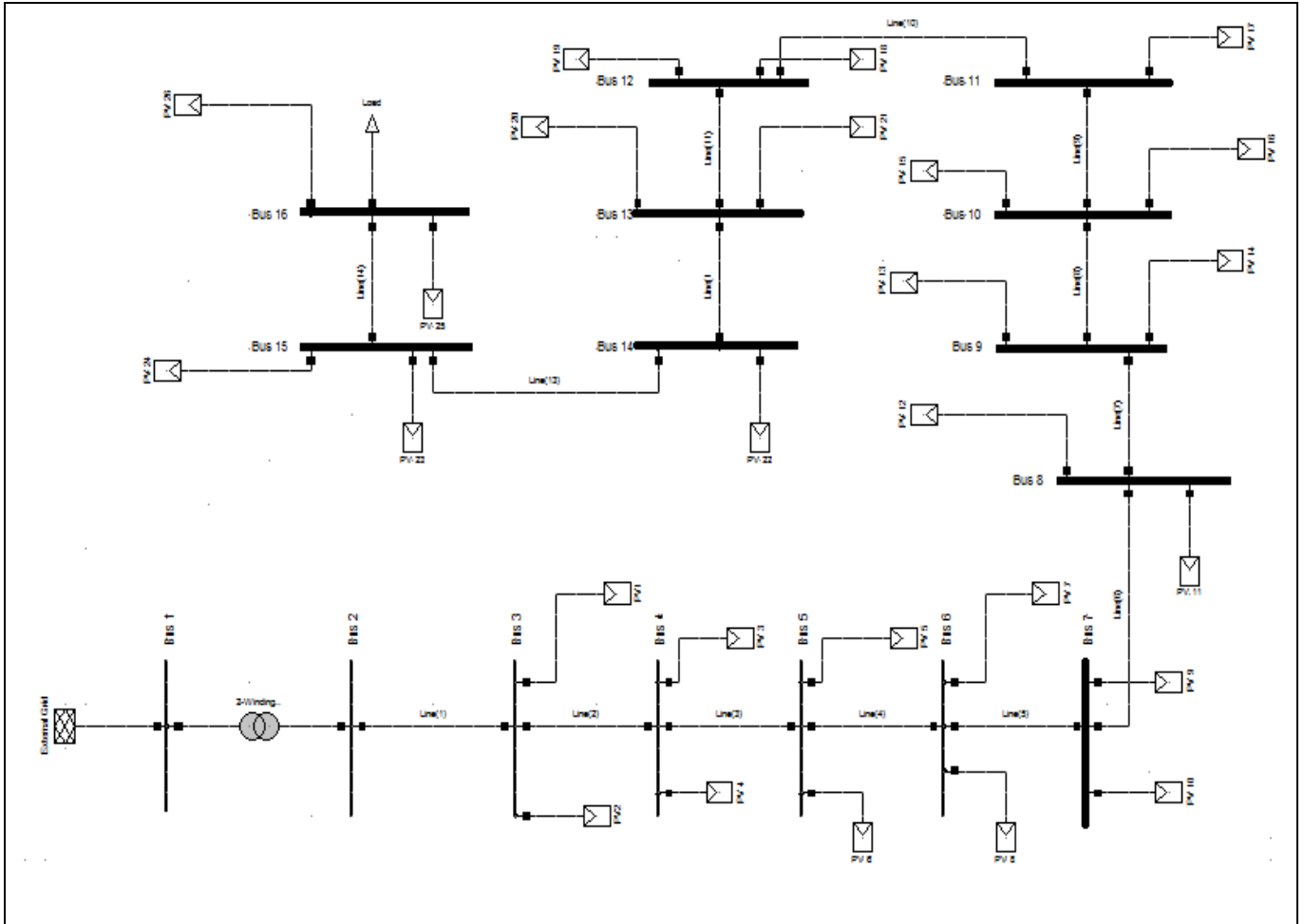

Figure 2: LV feeder with High PV penetration

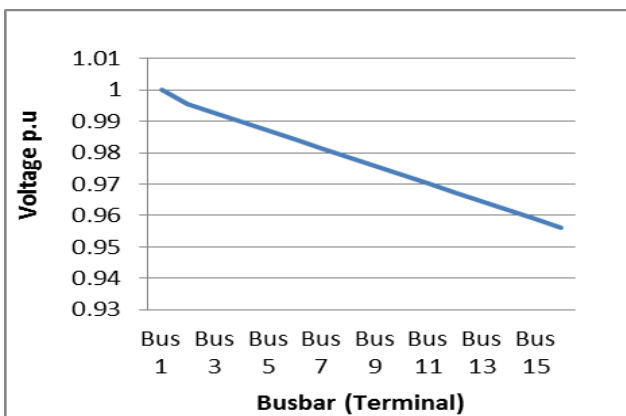

Figure 3: Distribution network voltage profile without PV penetration

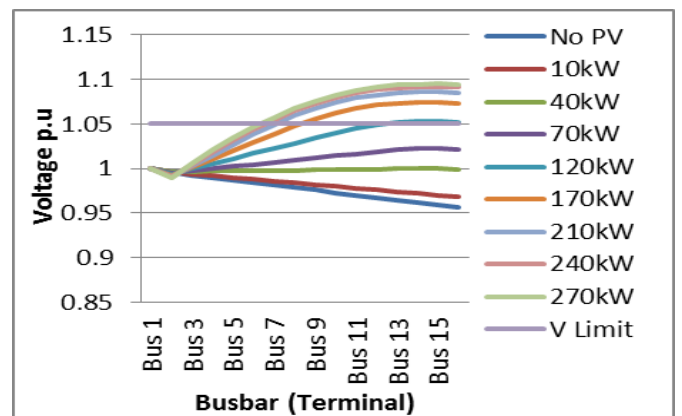

Figure 4: Impact of high PV penetration on Voltage profile in low voltage network

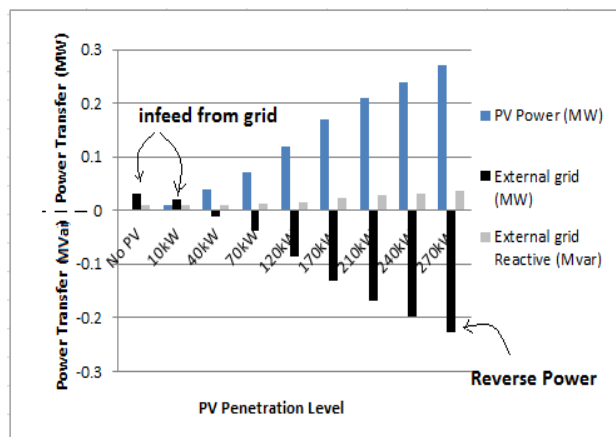

Figure 5: High PV impact on Power flow

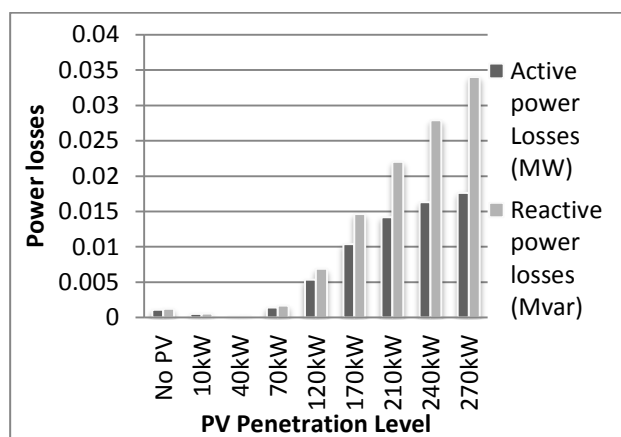

Figure 6: High PV impact on power losses

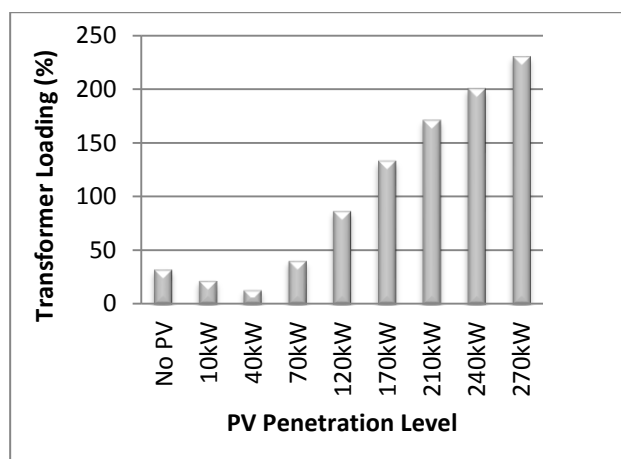

Figure 7: High PV impact on transformer loading

From figure 3, it is observed that the voltage profile of the network is maintains within the acceptable voltage range ( $\pm 5\%$ ) without PV penetration. Figure 4, shows how high PV penetration on the low voltage (LV) feeder has the ability to modify feeder voltage profile and this may lead to temporarily high voltage at the end of a long LV feeder lines. This affects the acceptable voltage level and may violate

utility planning limits and industrial acceptable standard. One of the main issues of PV penetration on the LV distribution feeder is the high penetration level of PV which can lead to reverse power flow from the downstream of the feeder to the upstream (substation transformer). The condition can affect the transformer loading (rated power) and conductor ratings. It can also affect over-current protection coordination and line voltage regulators. Figure 5, shows how high penetration level of PV can affect the direction of power flow, that is, from the downstream of the feeder to the upstream (substation transformer). This can also affect over-current protection coordination and line voltage regulators. It is observed in figure 6 that high PV penetration can modify the current of the feeder. This is because the injected PV is more than the load demand and excess generation is feed back to the grid. The condition can affect the transformer loading (rated power) as shown in figure 7, and conductor ratings. To curtail the impact some mitigation measures have been developed, this is discussed in section 4.

#### 4. MITIGATION MEASURES

The voltage range within medium and low voltage (MV and LV) network of the power system determines how efficient and durable an equipment or appliances can be (Carter-Brown. C. G, and Gaunt. C. T, 2006). However, the large penetration of PV systems on these low voltage networks will affect the standard voltage limits and security of the network. To enable a massive deployment of distributed energy resources (DER), it is imperative to develop coordinated and efficient control strategies for the operation and management of these resources. The impact issues have driven research to focus on control strategies that will accommodate and facilitate the integration benefits. The commonly suggested strategies used for voltage control where are (Robert. P et al, 2011; Erhan D, et al, 2009; Johan. H. R, 2010).;

- Storage device approach,
- Reactive power control,
- Reactive power compensation (FACTS devices; STATCOM, SVC etc) and
- Active power curtailment approach

Storage of excess power from the PV is also seen as an approach to regulate the voltage profile of the distribution feeder. Various types of storage devices like lead acid batteries, lithium-ion batteries and electric double layer capacitors can be used to control the voltage at the connection point (Xiaohu Liu, et al, 2012, Narsa. R. T, et al, 2013). Battery energy storage system (BESS) can also be used to regulate the power between the PV generation and utility grid to improve power quality in the grid. Reactive power support is another way of reducing the voltage at PCC. This is achieved by coordinating reactive power injection through individual PV based inverters or by centralised control of the reactive power (Thomas D et al, 2011, Masahide. H, et al, 2009, Erhan. D, et al, 2010). This method can be used to increase the number of PV in a such that the individual PV inverters will absorb or inject reactive power into the network. Reactive power compensation devices like STATCOM, SVC and shunt capacitor banks methods are



used to provide voltage regulation in distribution network. These devices provide better voltage control when there is a sudden voltage rise. A device such as STATCOM has the advantage of providing solution in fast response time, thus providing dynamic voltage control in the system (Reinaldo. T. et al, 2011, Junbiao. H, et al, 2012, Lasantha. B. P, et al, 2011). The use of this method evaluates the effectiveness of reactive power support to improve the steady state voltage profile of the distribution feeder. Curtailment of the PV active power is also a mitigation approach to prevent over voltage on the feeder with high PV integration (Tonkoski. R, et al, 2010, Tengku T. H et al, 2012, Conti. S, et al, 2006 ). This technique regulates the voltage rise issue at the point of common coupling by regulating active power of the renewable power source. These individual voltage control methods have shown the ability to control the voltage at PCC individually but if coordinated with link communication device and flexible control techniques to make the grid smarter, it will improve the voltage profile and increase the penetration of renewable system technologies most especially PV system.

### 5. SMART GRID

Low distributions networks are experiencing increasing penetration of renewable energy most especially PV and wind generating systems and this has transform the once known passive network to an active one. This means that power flow is now bidirectional and power can now flow from the downstream of the network to the upstream. This action has undermined the security, reliability and voltage stability of the distribution network. Due to these treat on the distribution network by Renewable energy systems and the issue of frequent outages, the ultimate smart grid in this context is now seen as the next big thing in the future. (Vasamma. K. M, 2012). From grid perspective, these new generation modes required improved control and monitoring of existing networks. Taking into account the aforementioned challenges, the energy community has started thinking to integrate information and communication technology (ICT) with electricity infrastructure (Hashimi M. et al, 2011).

A smarter grid is a grid that has the ability to heal itself whenever there is an impact that can threaten the security and stability of the power network. In order word, it can be described as an active grid or self-healing grid. It will allow significant savings in energy with better interconnections and enable an active role for consumers. The drivers of smart grid are often linked to sustainability, renewable energy system and reducing dependence on central fossil fuel energy systems in order to develop more efficient and resilient systems of production and consumption. There are different perspective, and understanding of a smarter grid. According to Hamid G and Reza. G, 2011, “ the smart grid can be defined as an electric system that uses information, two-way, cyber-secure communication technologies, and computational intelligence in an integrated fashion across the entire spectrum of the energy system from the generation to end point of consumption of the electricity”. (Arup, et al, 2011), defines smart grid as “the modernization of electricity delivery system so that it monitors, protects and automatically optimizes the operation of its interconnected

elements from the central and distributed generator through the high voltage network and distribution system”. The desire for smart grid is to re-engineer and redefine the traditional distribution network for better performance with renewable energy systems. It is seen as the next big thing in the future because of its ability to in cooperate large scale installation and full integration of renewable energy (PV, wind, etc) into the distribution network while maintaining reliability and better security. Distribution generation most especially PV’s are strongly connected to the idea of a smart grid and enable an active role for consumers to be involved in the electrical energy generation.

In the renewable perspective smart grid is the combination of the established mitigation measures (Distributed battery energy storage system, reactive power support, active power curtailment etc) and real-time communication to address the negative impact of renewable integration and making these measures to operate independently and automatically. An example of a smart grid system is described in Figure 8. The system describes the link of between different components, (e.g Substation, sensors, residential, commercial and industrial sites, etc.) and their communication path to provide interoperability between them.

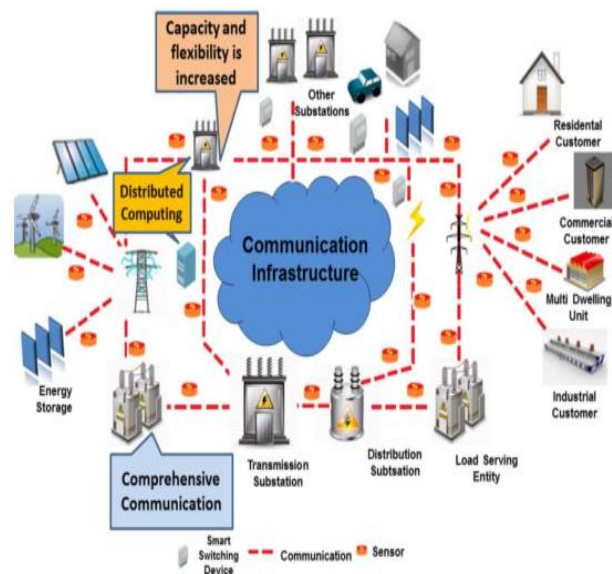

Figure 8: Smart grid infrastructure (Gungor V. C, 2011)

The availability of new technologies such as distributed sensors, two-way secure communication, advance software for data management, and intelligent and autonomous controllers has open up new opportunities for changing power systems (Hamid G and Reza. G, 2011) and this development will address most of the technical difficulties of integration renewable energy systems most especially PV system and creating a smarter and more efficient and sustainable grid. Smart grid should be incorporated into the future grid to help address most of the foreseen problems of power systems and the impact of renewable energy. Smart grid will be very much useful to the future grid because it can

do the following (Arup, et al, 2011,); (a) Accommodation of all sources of power (including renewable energy) and storage, (a) Self-healing, i.e. it can automatically detects and respond to routine problems and quickly recovers, (c) minimizing down time and financial loss and main technical and commercial loss reduction in power system.

## 6. CONCLUSION

In the last few years PV system application on the low and medium voltage distribution network is growing rapidly. These power grids will still experience more penetration by customers, small scale generation industries and utility operators in the nearest future due to government subsidies and falling price of photovoltaic panels. The penetration of PV seems to answer man's desire for an eco-friendly environment but the large scale penetration of PV opposes

## REFERENCE

- Alex Guinane, GM Shafiullah, Amanullah M. T. Oo, Blake E Harvey "Voltage Fluctuation in PV penetration on SWER Network – A Case Study For Regional Australia" Power and Energy Society General Meeting, 2012 IEEE, vol., no., pp.1,6, 22-26 July 2012
- Alam. M.J.E, K.M. Muttaqi, D. Sutanto "A comprehensive assessment tool for solar PV impacts on low voltage three phase distribution networks " Development in Renewable Energy Technology (ICDRET), 2012, 2nd International Conference. Pages:1-5
- Ali. S, N. Pearsall , G. Pulrus "Impact of High penetration Level of grid-connected Photovoltaic Systems on UK low voltage Distribution Network" International conference on Renewable Energies and power Quality (ICREPG'12), march 2012.
- AminMohammad Saberian, Payam Farzan, Mohsen Fadaee Nejad, Hashim Hizam, Chandima Gomes, Mohammad Lutfi b. Othman, Mohd Amran Mohd Radzi, Mohd Ainal Abidin Ab Kadir "Role of FACTS devices in improving penetration of renewable energy" Power engineering and optimization conference (PEOCO2013), 2013 IEEE 7th International, vol., no., pp.432, 437, 3-4 June 2013
- Arup Sinha, S. Neogi, R. N. Lahiri, S. Chowdhury, S. P. Chowdhury, N. Chakraborty "Smart Grid initiative for power distribution utility in India" Power and energy society general meeting, 2011 IEEE, Vol., no., pp. I, 8, 24-29 July 2011.
- Barry A. Mather "Quasi-Static time-series test feeder for PV integration analysis on distribution systems" Power and Energy Society Meeting, 2012 IEEE, vol., no., pp.1,8, 22-26 July 2012
- Bogdan-Lonut Craciun, Elena Anamaria Man, Vlad Alexandru Muresan, Dezso Sera, Tamas Kerekes, Remus Teodorescu " Improved Voltage Regulation Strategies by PV inverters in LV Rural Networks" Power Electronics for Distributed Generation Systems (PEDG), 2012 3rd IEEE International Symposium on , vol., no., pp.775,781, 25-28 June 2012
- Carlos Gonzalez, Jurgen Geuns, Sam Wedx, Thomas Wijmhoven, Pieter Vingerhoest, Tom De Rybel, Johnan Driesen "LV distribution network feeder in Belgium and power quality issues due to increasing PV penetration level" Innovative Smart Grid Technology (ISGT Europe), 2012 3rd IEEE PES International Conference and Exhibition on , vol., no., pp.1,8, 14-17 Oct. 2012
- Carter-Brown. C. G, C. T. Gaunt "Model for apportionment of the total voltage drop in combined medium and low voltage distribution feeders" South Africa Institute of Electrical Engineers" Vol. 97(1) march 2006
- Conti. S, A. Greco, N. Messina, S. Raiti "Local voltage regulation in LV distribution networks with PV distributed Generation" Power electronics, Electrical drives, Automation and Motion, SPEEDAM 2006, International symposium on, vol., no., pp.519,524, 23-26 May 2006
- Deema Al-Baik, vinod khadkikar "Effect of Variable PV power on the grid power factor under different load conditions" Electric Power And Energy Conversion Systems (EPECS), 2011, 2nd International Conference on, vol., no., pp.1,5, 15-17 Nov. 2011
- Dhaval Kumar Parmar, Liangzhong Yao "Impact of unbalance penetration of single phase grid connected photovoltaic generators on distribution network" UPEC 2011. 4th international universities power engineering conference.
- DigSilent powerfactory V15.0, DigSilent GmbH, Heinrich-Hertz-strasse-9,D-72810,Gomanringen. ([www.digsilent.de](http://www.digsilent.de)), 2013
- Erhan Demirok, Dezso Sera, Remus Teodorescu, Pedro Rodriguez, U. Borup "Clustered PV inverters in LV networks: An overview of impacts and comparison of voltage control strategies" Electrical Power and Energy Conference, 2009 IEEE, vol., no., pp.1,6, 22-23 Oct. 2009
- Erhan Demirok, Dezso Sera, Remus Teodorescu, Pedro Rodriguez, Uffe Borup "Evaluation of the voltage

- support strategies for the low voltage grid connected PV generators” Energy Conversion Congress and Exposition (ECCE), 2010 IEEE, vol., no., pp.710,717, 12-16 Sept. 2010.
- Gao. C, M. A. Redfern “A review of voltage control techniques of networks with distributed generations using On Load Tap Changer Transformers” UPEC 2010, 31st Aug-3rd Sept. 2010.
- Gungor V.C, Dilan Sahin, Taskin Kocak, Salih Ergut, Concettina Buccella, Carlo Cecatic, Gerhard P. Hancke “Smart Grid Technologies: Communication Technologies and Standards” IEEE Transactions on industrial informatics, Vol. 7, No 4, pp 529-539, November 2011.
- Hamid Gharavi, Reza Ghafurian “Smart Grid: The electric energy system of the future” The Electric energy system of the future [Scanning the issue], Proceeding of the IEEE, Vol. 99, no.6, pp.917, 921 June 2011.
- Hashmi M., S, Hanninen, K. Maki “Survey of smart Grid concepts, architectures and technological Demonstrations worldwide” Innovation Smart Grid Technologies (ISGT Latin America), 2011 IEEE PES Conference on , vol., no., pp.1,7, 19-21 Oct. 2011
- Johan H. R Enslin “Network impacts of high penetration of photovoltaic solar power systems” Power and Energy Society General Meeting, 2010, IEEE, vol., no., pp.1, 5, 25-29 July 2010
- Julio Romero Agüero; Steve J. Steffel “Integration challenges of photovoltaic distribution generation on power distribution systems” Power and Energy Society General Meeting, 2011 IEEE, vol., no., pp.1,6, 24-29 July 2011
- Junbiao Han, Sarika Khushalani-Solanki, Jignesh Solanki, Jens Schoene “Study of unified control of STATCOM to resolve the power quality issues of a grid connected three phase system” Innovative Smart Grid Technologies (ISGT), 2012, IEEE, PES, Sustainable Energy, IEEE Transactions on , vol.2, no.2, pp.139,147, April 2011
- Lasantha B. Perera, Gerard Ledwich, Arindam Ghosh “Distribution feeder voltage support and power feeder control by distributed multiple inverters” Electrical Power and Energy Conference (EPEC), 2011, IEEE, vol., no., pp.116, 1 21, 3-5 Oct. 2011
- Lewis S. J. “Analysis and management of impacts of a high penetration of photovoltaic systems in an electricity network” Innovation Smart Grid Technologies Asia (ISGT), 2011, IEEE Pes, Vol., no., pp.1,7, 13-16 Nov. 2011
- Madzonga L. S., J. L Munda, A. A. Jimoh “Analysis of bus voltage regulation and OLTC performance on mismatched parallel-connected Transformer” AFRICON, 2009. AFRICON '09. , vol., no., pp.1,5, 23-25 Sept. 2009
- Masahide Hojo, Hidetoshi Hatano, Yoshiaki Fuwa “Voltage rise suppression by reactive power control with cooperating photovoltaic generation systems” CIRED, 20th International conference on electricity distribution, Prague, 8-11, June 2009, Paper 0301
- Matthew Owen, Robert van der Plas, Steve Sepp “ Can there be energy policy in sub-saharan Africa without biomass?” Energy for sustainable development 17 (2013) 146-152
- Mesut E. Baran, Hossein Hooshyar, Zhan Shen, Alex Huang “Accommodating High PV penetration on Distribution feeders” IEEE Transactions on smart grid Vol. 3 No. 2 June 2012
- Narsa Reddy Tummuru, Mahesh K. Mishra, S. Srinivas “Integration of PV/Battery Hybrid Energy Conversion System to grid with power quality Improvement Features” Industrial Technology (ICIT), 2013 IEEE, International Conference on , vol., no., pp.1751,1756, 25-28 Feb. 2013
- Nick Hiscock, Terence G. Hazel, Jonathan Hiscock “Voltage regulation at sites with distribution generation” IEEE Transactions on industry applications, Vol. 44, No 2. March/april, 2008
- Pathomthai Chiradeja, R. Rmakanar “An approach to qualify the technical benefits of distributed generation” Energy Conversion, IEEE Transactions on, vol.19, no.4, pp.764,773, Dec. 2004.
- Pepermans. G, J. Driesen, D. Haeseldonckx, R. Belmans, W. D’haeseleer “Distribution generation: benefits and issues” Energy policy 33 (2005) 787-798
- REN 21, 2011- Renewable 2011 Global Status Report. Renewable energy policy network for the 21st century.
- Sarika Khushalani Solanki; Vaidyanath Ramachandran; Jignesh Solanki “ Steady state analysis of high penetration of PV on utility distribution feeder ” Transmission And Distribution Conference and Exposition (T&D), 2012 IEEE PES, vol., no., pp.1, 6, 7-10 May 2012
- Smainverter. Grid Integration of Distributed PV – Generation, [www.smainverter.com/2012/10/18/grid-integration-of-distributed-pv-generation/](http://www.smainverter.com/2012/10/18/grid-integration-of-distributed-pv-generation/) viewed 6.18 am, 27th August 2013-08-28
- Tengku Juhana Tengku Hashim, Azah Mohamed, Hussain Shareef “A review on voltage control methods for active distribution networks” PRZEGLAD ELEKTROTECHNICZNY (Electrical review). R. 88 NR 6/2012
- Thomas Ackermann, Goran Anderson, Lennart Soder (2001) “Distribution generation: A definition” Electrical power system Research 57, 195-204
- Thomas Degner, Gunter Arold, Thorsten Reimann, Bernd Engel, Michael Breede, Philipp Strauss “Increasing the photovoltaic system hosting capacity of low voltage distribution networks” CIRED, 21st international

conference on electricity distribution, Frankfurt, 6-9,  
June 2011, paper 1243

Tonkoski, R., Liuz A. C. Lopes, T. H. M. EL-Fouly  
“Coordinated active power curtailment of grid  
connected PV inverters for overvoltage prevention”  
Sustainable Energy, IEEE Transactions on , vol.2, no.2,  
pp.139,147, April 2011

Tonkoski, R., L. A. C. Lopes, T. H. M. EL-Fouly “Droop-  
based Active Power Curtailment for Overvoltage  
Prevention in Grid connected PV Inverters” IEEE  
International Symposium on Industrial Electronics, vol.,  
no., pp.2388,2393, 4-7 July 2010

Valsamma K. M “Smart Grid as a Desideratum in the energy  
landscape: Key Aspects and Challenges” Engineering  
Education: Innovative Practices and Future Trends  
(AICERA), 2012 IEEE International Conference on ,  
vol., no., pp.1,6, 19-21 July 2012

Xiaohu Liu, Andreas Aichhorn, Liming Liu, Hui Li  
“Coordinated control of distributed energy storage  
system with tap changer transformers for voltage rise  
mitigation under high photovoltaic penetration” Smart  
Grid, IEEE Transactions on , vol.3, no.2, pp.897,906,  
June 2012