

Process Education and Development Infrastructure Building by Virtual Plant in DCS Manufacturing Company

Yuuta Machida*, Makoto Nakaya*, Toshiaki Omata*

* *Application Technology Development & Engineering Dept. Industrial Automation Systems Business Division, Yokogawa Electric Corp., 2-9-32 Nakacho, Musashino-shi, Tokyo, Japan
(Tel:+81-422-52-9764;e-mail:Yuuta.Machida@jp.yokogawa.com)*

Abstract: When distributed control system (DCS) was first developed, there were a number of control engineers with deep knowledge of customer's process in DCS manufacturing companies. At present, however, engineers working in DCS companies are strongly involved in new technologies, such as networking and security. Therefore, DCS engineers are somewhat isolated from the customer's process. To gain a better understanding of the customer's process and operation, a vinyl acetate monomer (VAM) virtual plant was developed. Using this virtual plant, we allowed engineers involved in the development of operation support software to experience plant operation. This training was effective because the engineers gained insights into both advantages and disadvantages of their designs. The VAM virtual plant was utilized as not only a training tool but also as a development infrastructure. This paper reports that the virtual plant contributes to training of young engineers and facilitates product development in a DCS manufacturing company.

Keywords: Process education, Simulator, Virtual plant, VAM, DCS manufacturing company

1. INTRODUCTION

With rapid advances in computer technology, distributed control systems (DCS) have come to play important roles in process industries for the progress of industrial automation systems. In addition, advanced process control systems including multivariable predictive control (MPC) contribute to stabilization and optimization of processes in industrial plants.

However, job categories are highly segmented within companies in process industries. For example, many engineers with overall knowledge, including that of instrumentation systems, are often involved in the plant construction stage in petroleum and petrochemical companies. After commissioning, the plant achieves stable production, but segmentation of job categories slows progress and the engineers working at the plant are engaged in only a limited scope of work. Therefore, engineers with wide knowledge, including process design, process control, DCS, and instrumentation, etc., are rare.

A plant generally has a lifespan of about 40 – 50 years, and the engineers engaged in construction of the plant may have already retired or been transferred to other sections. Thus, there is constant generational turnover of engineers in plants. The opportunities to experience unsteady plant operation decrease dramatically because the long maintenance span and small-scale plant reconstructions preventing plant engineers

from utilizing practical overall process knowledge.

Recently, Japanese process industries have required redesign of plant operation because of high material costs, strong yen, power shortages, etc. Although operator training simulators help to maintain operation skill even under unsteady conditions for a plant operator, training of young technical staff working in the plant is an important consideration.

To resolve these issues, Work Shop No.27 (WS27) of Process Systems Engineering No.143 Committee (PSE143), which belongs to the Japan Society for the Promotion of Science, proposed utilizing plant models. The best known benchmark for researching plant-wide control is the Tennessee Eastman plant, which deals in virtual materials (Gade Pandu Rangaiah, and Vinay Kariwala, (2012)). However, WS27 of PSE143 adopted an existing vinyl acetate monomer (VAM) plant model. The VAM model was installed in a dynamic plant simulator rather than a general process simulator.

2. ISSUES FACED BY DCS COMPANIES

2.1 Merits and Demerits of DCS Manufacturer

Our company, Yokogawa Electric Corp. is a pioneering manufacturer of DCS. Prior to the inception of DCS in the 1970s, DCS vendors and Japanese users worked in collaboration to develop direct digital control (DDC) and

discuss application of digital computers for process control. After the development of microprocessors capable of simultaneously calculating control loops, the distributed digital control technology was developed as DCS. DCS has been introduced in many plants around the world, and has exerted an effect on complicated advanced control, sequence control, and recipe management in batch processing. When DDC was first developed, many engineers that had been deeply engaged in process control participated in both DCS manufacture and application. DCS was widely adopted at users' sites. There have been decreases in the number of not only plant operators but also in the number of technical staff. Hence, there are few process control engineers working in modern plants.

On the other hand, in the 1980s, DCS manufacturers had to deal with new technology, such as networks and Microsoft Windows. Therefore, DCS manufacturer engineers lost the opportunity to discuss their customer's processes and concentrated mainly on improving DCS performance. Currently, Japanese chemical companies have a tendency to shift their own factories overseas or to join in collaborations with overseas companies. Therefore, DCS vendors have new business opportunities with DCS users because Japanese chemical companies are constructing new plants in other countries. Thus, it is necessary for DCS engineers to gain an intimate understanding of the customer's process to propose solutions to optimize control and achieve safer operation.

This paper discusses the effective use of a virtual plant run on a computer for training and development infrastructure building in our organization.

2.2 Problems of Utilizing Mini Plant

Generally, DCS vendors do not actually take possession of an actual production plant. We constructed a mini-plant at our company to obtain process knowledge and gain experience of plant operation. Figure 1 shows the methane steam reforming equipment and the fuel cell power generation instrument in the mini-plant. We assume that these two mini-plants are chemical and electrical power plants, respectively. Although the mini-plant provides actual plant data and operation experience, it is very difficult to maintain as it requires utilities, safety apparatus, and hazardous material management.

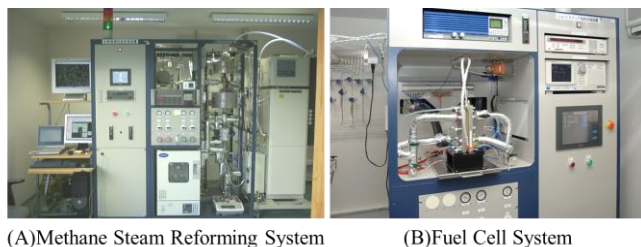

Fig. 1. Mini-plant in our company

2.3 Process Training by Virtual Plant

A virtual plant constructed on computer has a number of advantages compared to a mini-plant. The virtual plant can be run faster than real-time and can be operated at critical points, such as the explosion limit. Table 1 shows the advantages and disadvantages of the virtual plant vs. the mini-plant. The greatest advantage of the virtual plant is the lack of maintenance costs.

DCS manufacturers that cannot possess a real commercial plant make heavy use of virtual plants for training, product development, and testing (see Fig. 2). Conventionally, DCS development engineers spend little time considering the operating behavior of their customer's plant. By connecting our developed product with the virtual plant, the engineer can evaluate operation-supporting software from the customer's point of view.

PSE143 provides a trial version of the VAM plant model and dynamic plant simulator on the following website (<http://www.omegasim.co.jp/product/vm/cnt4/index.htm>).

Table 1. Features of mini-plant and virtual plant

	Mini-plant	Virtual plant
Advantages	Real plant data acquisition Data reliability Allows many sensor installations Feels the sound, vibration and smell	Low cost of plant construction Low cost of rebuilding No maintenance fee Faster calculation than realtime
Disadvantages	High cost of plant construction High cost of maintenance High cost for safety measures High cost for legal compliance	model version management

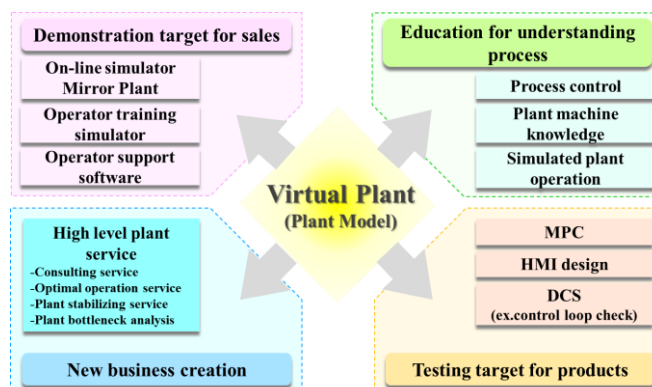

Fig. 2. Application of virtual plant in DCS companies

3. FORMULATION OF VIRTUAL PLANT

We developed the VAM virtual plant system which consists of operator training simulator, distributed control system, safety instrumentation system, and operation assistance system. VAM stands for Vinyl Acetate Monomer, which is one of the major petrochemical products generated from ethylene, acetic acid and oxygen. The production process model of VAM virtual plant is constructed in the motif of the real process. Users of the VAM virtual plant can operate whole of VAM production system as if they are plant

operators. Figure 3 shows the formulation of the VAM virtual plant. The VAM virtual plant is configured with the following system components, and runs on a single laptop PC without special instruments, such as field sensors, input/output terminals, controllers, etc.

- Dynamic simulator and plant model

The behavior of the VAM production process is simulated in the process model of dynamic simulator software. We diverted and modified the process model of the VAM production process, which is provided by WS27 of PSE143 (Hiroya Seki et al. (2010)). This model is implemented in OmegaLand, which is a commercial dynamic process simulation package based on rigorous first-principles models and has abundant industrial applications for operator training.

- Distributed control system (DCS)

The process control logics and human-machine interface (HMI) of the VAM production process are implemented in CENTUM VP (Yokogawa Electric Corp.). Control logics (PID controllers, indicators, switches, etc.) and operation graphics are emulated on a laptop PC via the test function of CENTUM VP, and the input/output terminals of the controller are connected to the process model via a dedicated software interface. The VAM virtual plant users can operate processes through the graphical HMI of DCS which is shown at Fig. 4.

- Safety instrumentation system (SIS)

This system shuts down the plant when the process state goes into an unsafe situation (runaway reaction of reactor, etc.). The shutdown logic is implemented in ProSafe-RS (Yokogawa Electric Corp.), which is a safety instrumentation system software package and can connect seamlessly to DCS. Users of the VAM virtual plant can indicate the states of shutdown logics and shutdown actuators via the HMI of DCS, and shutdown logics is emulated on a laptop PC similar to CENTUM VP.

- Operation assistance system

This system can automate or assist manual plant operations with operation assistance procedures, including startup operation, load change operation, etc. The operation procedure is implemented in Exapilot (Yokogawa Electric Corp.), which is an advanced operation assistance software package that can configure the operation assistance procedure intuitively in flowchart-style language. This package is connected to DCS via the OPC interface and can be used to manipulate the control instruments defined on DCS according to the operation assistance procedure.

Currently, users can experience the following plant operations with this system.

- Startup operation
- Production load change operation
- Emergency shutdown operation

These operations are realized by the board operation of DCS. On the other hand, actual plants have many field operations. For example, visual confirmation of field instruments, manipulation of hand-operated valves, etc. The current system has cut-down functions for field operations, but we can implement these functions in the future.

Usages of VAM virtual plant in DCS manufacturing companies are wide-ranging as following.

- Chemical process education
- Plant operation experience
- Control logic engineering experience
- Testing environment of process control systems (PID tuning, testing of sequence logics, interlock logics and so on)
- Demonstration and testing environment of new products

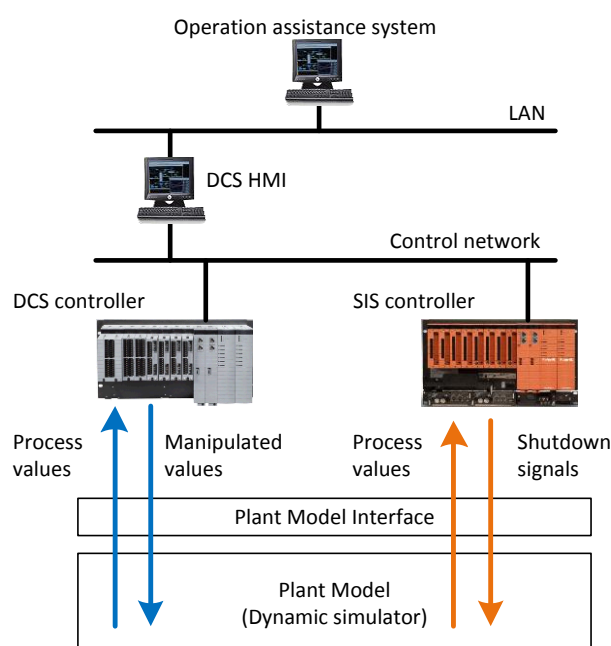

Fig. 3. System structure diagram of virtual plant

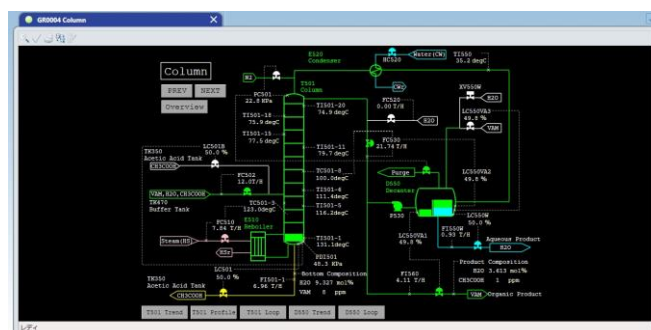

Fig. 4. Operation HMI of VAM virtual plant

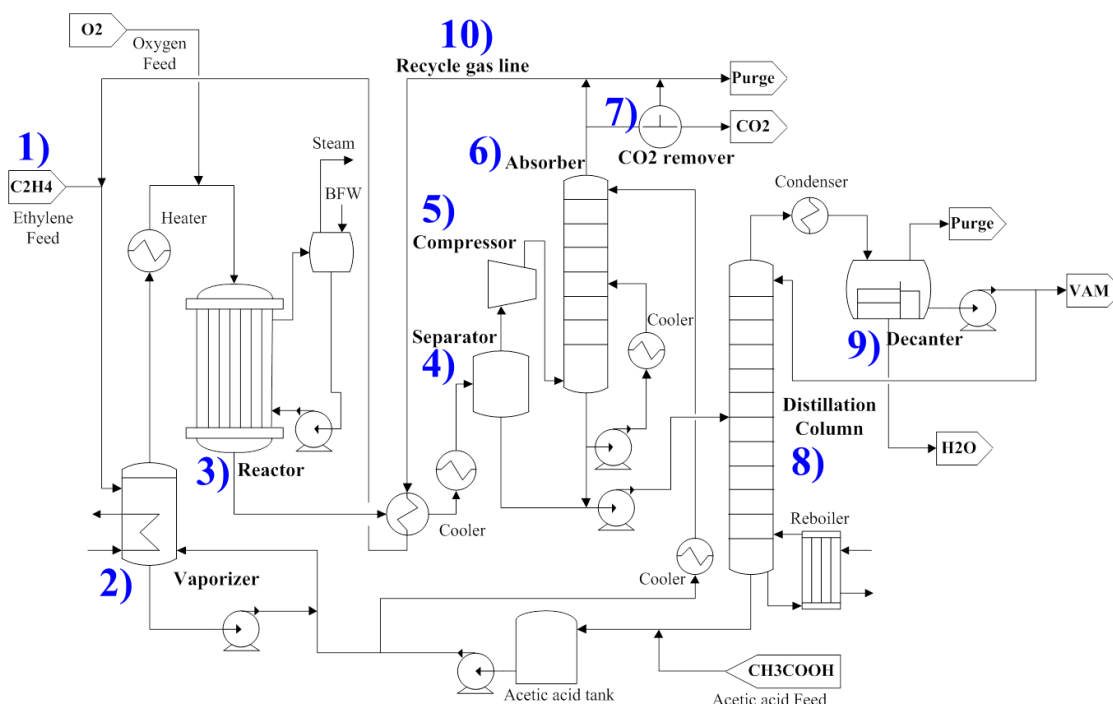

Fig. 5. VAM process flow diagram

Figure 5 shows the VAM production process flow diagram (Alexandre C. Dimian et al. (2011) and Michael L. Luyben et al. (1998)). The VAM production process is consisted of typical chemical process units and pipe lines, such as reactor, distillation column, recycle flow. This process can produce VAM product at the rate of 4.5t/h. The main parts of VAM production process are as follows.

1) Raw material feed

Three raw materials, i.e., ethylene (C₂H₄), oxygen (O₂), and acetic acid, are fed into the process. VAM producing reaction occurs in the vapor phase, so these materials are supplied as vapor. The three raw materials are mixed and heated to the desired reactor inlet temperature in the pre-heater, and then supplied to reactor. Fresh ethylene contains 0.1 mol% ethane, which does not participate in reactions in the reactor.

2) Acetic acid vaporizer

Acetic acid is stored in liquid phase in a tank. A stream of liquid acetic acid is passed into the vaporizer, where it is heated and vaporized by steam. The gas stream from the top of the vaporizer is joined to the raw material feed stream and flows to the reactor.

3) Reactor

VAM production reaction occurs in the multi-tubular reactor. The tube side is packed with a precious metal catalyst on a silica support, and the shell side is filled with coolant (Boiler Feed Water: BFW). The following two reactions occur in this reactor.

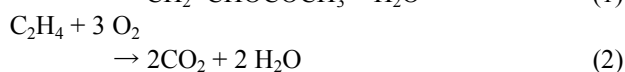
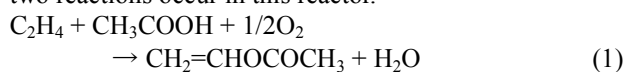

The first is the main reaction that generates VAM, and the second is a side reaction. Both of these reactions are

exothermic; the reaction heat of the main reaction is 176.2 kJ/mol, while that of the side reaction is 1323 kJ/mol.

The reaction heat is removed from the reactor by generation of steam on the shell side of the reactor. BFW flows to the shell side of the reactor from the steam drum and circulates between the steam drum and the reactor. BFW is vaporized as saturated steam by the reaction heat and leaves the steam drum.

4) Separator

The reactor effluent is cooled to about 30°C with recycled gas and cooling water. The reactor effluent flow is separated to vapor (ethylene, oxygen, CO₂, ethane) and liquid (VAM, water, acetic acid) in the separator. The vapor stream flows to a compressor, and the liquid stream is fed to a distillation column.

5) Compressor

The gas stream emerging from the separator is passed into the compressor and the pressure is increased to 840 kPaG. The compressor discharge flows through the absorber and forms a recycled gas circulation flow.

6) Absorber

The compressor discharge includes a fractional VAM component, which is absorbed with cold acetic acid in the absorber. The compressor discharge and cold acetic acid are fed from the bottom and top of the absorber, respectively. The VAM component is then absorbed to acetic acid, and flows out from the bottom of the absorber as a liquid stream. A part of the liquid stream is cooled and recirculated to the middle of the absorber, and the remainder is combined with the liquid flow from the separator and fed to the distillation column. On the other hand, the gas stream (ethylene, oxygen, CO₂, ethane) from the top flows to the CO₂ remover.

7) CO₂ remover

This unit removes CO₂ from the overhead gas flowing out of the absorber. The removed CO₂ is purged to the atmosphere and the remaining gas is recycled to the raw material feed line. A part of the recycled gas is purged from the process to remove ethane.

8) Distillation column

The azeotropic distillation column separates VAM and water from the unconverted acetic acid. The top product of column (VAM and water) is condensed in the overhead condenser and flows to the decanter. The bottom product (unconverted acetic acid) is recycled to the acetic acid tank, and flows again to the vaporizer.

9) Decanter

The top product of column is condensed and passed to the decanter, where liquid-liquid separation then takes place. The VAM phase floats on the water phase because of its lower specific gravity. VAM flows out from the decanter as organic product, part of which is returned to the distillation column as reflux flow. Water flows out from the bottom of the decanter as aqueous product. We ignored the additional separation steps required to produce VAM of sufficient purity, so that the organic product from the decanter was the final product of this process.

10) Recycle gas line

The effluents from the absorber and CO₂ remover (unconverted ethylene and oxygen) are combined and returned to the raw material feed line.

4. TRAINING PROGRAM BY VAM VIRTUAL PLANT

Here, we will introduce use of the VAM virtual plant as a training tool. We organized the training program using the VAM virtual plant for system product developers in our company with no chemical process engineering background. The purposes of the training program were as follows.

- Feel and learn the technical sense of the plant operation
- Rediscover advantages and disadvantages of our company's product.
- Enhance comprehension for product development requirements from our company's customers.
- Obtain knowledge and insight to develop future products and new solutions for process industries.

4.1 Process Training Program

We devised the training program to achieve the purposes noted above through operation of the VAM virtual plant.

- 1) Brief explanation of whole image of the VAM virtual plant
- 2) Explanation of principle of reactor and column
- 3) Explanation of the plant operation procedures
- 4) Whole Plant startup operation exercise by manual operation
- 5) Demonstration of automatic startup operation with use of operation assistance system

This program takes about 16 h. Trainees operate the plant step by step with receiving an explanation about process and understanding principles and background knowledge. Trainees have no chemical engineering experience, so that we

carefully teach chemical process literacy for them at an appropriate level.

We also composed following text for this training program.

- 1) Standard operation procedures (SOP)
- 2) Operating principle guidance
- 3) Other materials (P&ID, Material balance sheet etc...)

These texts designed to lead trainees to understand whole image of the VAM virtual plant, principles of each process units, and background of plant operation.

4.2 Plant Operation Exercise

This is the most important part of our training program. First, we teach fundamental knowledge, and then take trainees through the manual startup operation of the VAM virtual plant. The startup operation procedure is as follows.

- 1) Put material liquid to tank and decanter.
- 2) Startup the distillation column and run in to standby state.
- 3) Gas pipe lines make up with ethylene gas.
- 4) Warm up the reactor and run in to standby state.
- 5) Startup the absorber and run in to standby state.
- 6) Startup the vaporizer and start circulation of acetic acid.
- 7) Preparation for initiation of producing VAM.
- 8) Feed oxygen and starts VAM producing reaction.
- 9) Release VAM product from decanter and stabilize whole of process.

This operation takes about 4 h on the real time scale, but we shorten this time by using the fast-forward function of the dynamic simulator. The main purpose of this exercise is not only to gain an understanding of usability of our products but also to experience the plant operator perspective. After the manual operation exercise, automatic operation by the operation assistance system is demonstrated to rediscover the advantages of our company's software package.

4.3 Results of Training

Figure 6 shows a part of startup operation's historical data. It shows failure case and success case of distillation column startup operation. At the failure case, trainee made miss operation which over heated whole of column at the initial heating phase and released off-spec product from column top. After failure operation, they reaffirm SOP and principles of distillation column and retried. Then as shown in success case figure, they succeeded to starting and stabilizing of distillation column properly. Trainees experienced many trial and errors like this case through the whole of startup operation. Finally, trainees finished whole of startup operation procedures and commenced producing VAM production. After the plant operation exercise, trainees gave the following responses.

- I gained enriched understanding of chemical processes through the operation exercise.
- I felt nervous when operating the virtual plant, and understood the difficulty of plant operation that requires a picture of the internal situation of the process unit through only the process value displayed on the HMI.
- I confirmed that my product that is near release is quite effective for plant operation, and gained motivation for product development

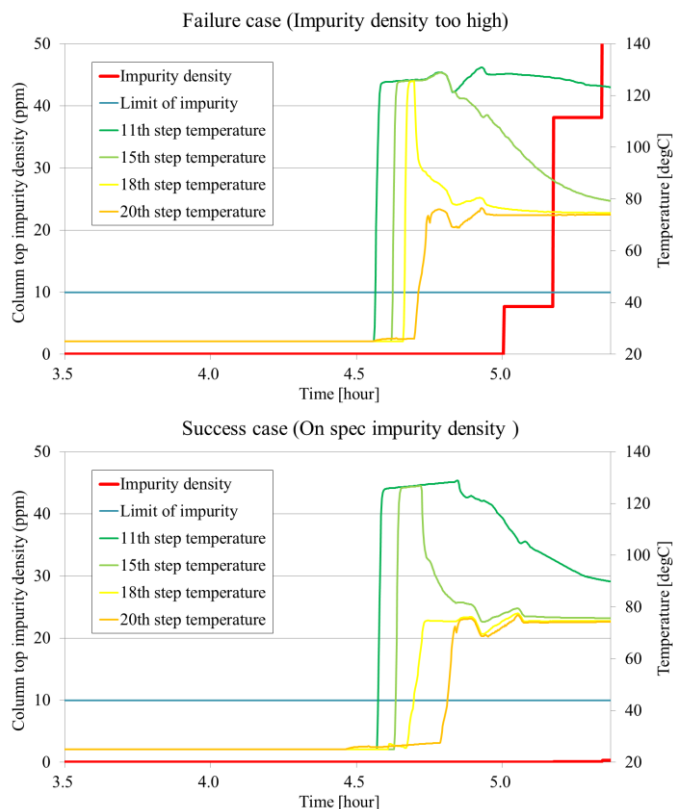

Fig. 6. Operation history example of distillation column

We consider the training program with use of the VAM virtual plant to be effective for process automation system developers. In addition, we also expect that this program will close the gaps between customers and process instrumentation vendors and serve as an important driving force in the development of new products and solutions for safe, stable, and high-efficiency plant operation.

5. DEVELOPMENT USING VIRTUAL PLANT

Mirror Plant, the dynamic process simulator that runs in parallel with the actual plant, can accurately simulate dynamic plant behavior, because the model parameters inside the simulator are constantly adjusted to gradually match the actual plant behavior (Makoto Nakaya et al. (2013)). Mirror Plant is able to estimate process data that cannot be actually measured. By making the computer run faster than real time, Mirror Plant can predict the future plant behavior precisely. Mirror Plant will be released in the near future as a new product by our company. We applied the Mirror Plant system to the VAM virtual plant to introduce the functions of this product. Figure 7 shows the operation HMI of Mirror Plant. To increase VAM production volume, the temperature of the reactor is increased and the operator can look ahead to see the temperature distribution inside the reactor 1 h in the future. The predicted temperature generated by the reaction heat in the reactor triggers an alarm.

The industrial designers in our company also took part in the Mirror Plant development project. They considered how to express prediction data on the screen and completed Mirror Plant HMI based on ergonomic design. As the VAM virtual

plant is connected with DCS, the designers could evaluate their HMI using dynamic plant behavior. The virtual plant provided different design conditions to decide on color combinations and pop-up window structure.

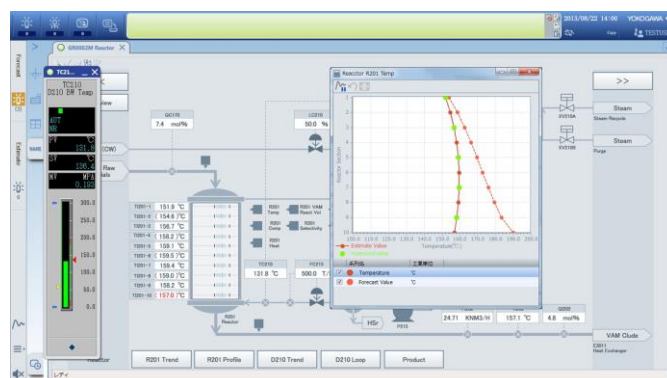

Fig. 7. Mirror Plant HMI

6. CONCLUSIONS

We have developed a VAM virtual plant that can be controlled by DCS. The developed virtual plant includes a reactor, separator, distillation column, and recycling line, all of which are basic elements of a chemical plant. This virtual plant was used for plant operation training of engineers in our company. Through this training, they gained a greater awareness of the advantages and disadvantages of our products. They reported that experience of plant operation would be applied to future product development. In addition, we applied Mirror Plant, which is new product from our company, to the VAM virtual plant to introduce the functions of this product. The VAM virtual plant developed here will be used both inside and outside our company, and we hope that the VAM plant model will become a benchmark in the process control field.

REFERENCES

- Gade Pandu Rangaiah, Vinay Kariwala. PLANTWIDE CONTROL, chapter 9, Wiley, 2012.
- Alexandre C. Dimian, Costin Sorin Bildea. Chemical Process Design, chapter 10, Wiley, 2011.
- Michael L. Luyben, Bjorn D. Tyreus. An industrial design/control study for the vinyl acetate monomer process, Computers and Chemical Engineering. Vol. 22, No.7-8, pp.867-877, 1998.
- Hiroya Seki, Morimasa Ogawa, Toshiaki Itoh, Shigeki Ootakara, Hisashi Murata, Yoshihiro Hashimoto, Manabu Kano. Plantwide control system design of the benchmark vinyl acetate monomer production plant, Computers and Chemical Engineering 34, pp.1282-1295, 2010
- Makoto Nakaya. MIRROR PLANT for Innovative Plant Operation, Yokogawa Technical Report, Vol.56, No.1, pp7-10, 2013.
- Makoto Nakaya, Xinchun Li. On-line tracking simulator with a hybrid of physical and Just-In-Time models, Journal of Process Control, Vol.23, pp171-178, 2013