

Robust Output H_∞ Fuzzy Control for Active Fault Tolerant Vehicle Stability

M. Oudghiri, *Student Member, IEEE*, M. Chadli and A. El hajjaji

*Laboratoire de Modélisation, Information et Systèmes
University of Picardie Jules Verne
Tel: +33(0)3-82-22-76-84/84
E-mail: { mohammed.oudghiri, mohammed.chadli,
ahmed.hajjaji }@u-picardie.fr*

Abstract: This paper presents an active Fault Tolerant Control (FTC) strategy for vehicle lateral dynamics. A bicycle vehicle model using small angle approximations is used to represent vehicle behavior. Firstly, the nonlinear lateral vehicle dynamics is approximated by a Takagi-Sugeno fuzzy model with parametric uncertainties and sensor faults. Secondly a robust H_∞ output controller is used. A method based on a bank of observers is used for detection and isolation of sensor faults. The effectiveness of the proposed strategy have been illustrated in simulation.

Keywords: Fault Tolerant Control; Vehicle Dynamics; Takagi-Sugeno fuzzy model; H_∞ Robust Control, LMI.

Nomenclature

a_f	Front axle distance from the center of gravity (m)
a_r	Rear axle distance from the center of gravity (m)
C_f	Front lateral cornering stiffness (N/rad)
C_r	Rear lateral cornering stiffness (N/rad)
J	yaw moment of inertia (kg m^2)
μ	road adherence
$\alpha_{f,r}$	Front and rear tyre slip-angles (rad)
δ_f	Road wheel steer angle (rad)
u	longitudinal velocity (m/s)
v	lateral velocity (m/s)
a_y	lateral acceleration (m/s^2)
r	yaw rate about the center of gravity (rad/s)
M_z	yaw moment (Nm^2)

1. INTRODUCTION

Vehicle active control systems aim to enhance handling and comfort characteristics ensuring stability in critical situations. In this context, several systems have been developed these last years (ABS, ASR, TCS, DYC ...) and some of them have already been commercialized and becoming a standard equipment in many vehicles. However, faults or abnormal operations of any or some of components of such a system can prove extremely costly and in some cases create situations that are dangerous to the safety of passengers. Our objective is to develop an active fault tolerant controller for vehicle lateral dynamics against sensors failures. To do so, a new strategy based on a method of Fault Detection and Isolation (FDI) (Isermann (2001); Ding et al (2005); Blanke et al (2003)) is developed so as to avoid sensor fault effect on vehicle system where faults are assumed to be incipient, abrupt but not generate a total sensor faults. The fault detection

scheme uses a bank of observers each utilizing a different output measurement to estimate the vehicle states. The analytical redundancy provided by the bank of observers is then used to construct residuals that have unique signatures in the presence of faults.

Two fuzzy robust H_∞ observer-based controllers developed in (Oudghiri et al (2007a)) have been used, each one utilizes different output sensor to reconstruct vehicle state variables, after the detection and the isolation of sensor fault, a switching block selects the controller which has used the output of the healthy sensor in order to maintain the stability of the vehicle.

The proposed method is based on the uncertain Takagi-Sugeno (T-S) fuzzy representation largely used in control and estimation problems of nonlinear systems these last years (Kim et al (1999); Tanaka and Wang (1998); Korba et al (2003); Chadli and El hajjaji (2006); Chadli et al (2008)). This representation allows to describe the vehicle dynamics in large domain and by the same way to improve the stability of vehicle lateral dynamics. The proposed stability conditions of the closed loop system are given in terms of Linear Matrix inequalities (LMI) (Boyd et al (1994)) and can be solved in a single-step procedure. Based on work given in (Oudghiri et al (2007b)), this paper introduces some improvement by taking account external disturbance and considering uncertainties on all system matrices.

This paper is organized as follows. Section II briefly describes the used vehicle models in uncertain T-S representation. Section III gives the robust H_∞ fuzzy observer based controller. Section IV presents the Fault Tolerant Control (FTC) scheme used to stabilize the lateral vehicle dynamics. Section V presents the simulation results that validate the proposed algorithm. Conclusions are given in

Section VI.

Notations : The symbol * denotes the transpose elements in the symmetric positions. $P > 0$ means a positive-definite symmetric matrix P .

2. UNCERTAIN TAKAGI-SUGENO FUZZY VEHICLE MODEL

Let us consider the following two freedom degree vehicle lateral dynamics model, it is given in terms of the lateral velocity v and the yaw rate r

$$\begin{pmatrix} \dot{v}(t) \\ \dot{r}(t) \end{pmatrix} = \begin{pmatrix} 2 \frac{F_{yf}(t) + F_{yr}(t)}{J} - u(t)r(t) \\ 2 \frac{a_f F_{yf}(t) - a_r F_{yr}(t)}{J} + \frac{M_z(t)}{J} \end{pmatrix} \quad (1)$$

where F_{yf} and F_{yr} are front and rear lateral forces respectively, their nonlinear expressions are given in ?, Bakkern et al (1989). They have been approximated by two fuzzy rules as follows

$$\begin{cases} F_{yf} = \sum_{i=1}^2 h_i(\alpha_f) C_{fi}(\mu) \alpha_f \\ F_{yr} = \sum_{i=1}^2 h_i(\alpha_r) C_{ri}(\mu) \alpha_r \end{cases} \quad (2)$$

where $h_i(i = 1, 2)$ are the membership functions, they satisfy the following conditions

$$\begin{cases} \sum_{i=1}^2 h_i(\alpha_f) = 1, \\ 0 \leq h_i(\alpha_f) \leq 1, \forall i = 1, 2. \end{cases} \quad (3)$$

α_f and α_r represent tyre slip-angles at the front and rear of the vehicle respectively such that

$$\begin{aligned} \alpha_f &= -\frac{v + a_f r}{u} + \delta_f(t), \\ \alpha_r &= -\frac{v - a_r r}{u}, \end{aligned} \quad (4)$$

C_{fi} and C_{ri} represent front and rear lateral tyre stiffnesses, they are difficult to estimate accurately and also exhibits large variations due to the road adhesion μ . To take into these variations, we assume that these coefficients vary as follows

$$\begin{cases} C_{fi} = C_{fi0}(1 + d_i f_i) \\ C_{ri} = C_{ri0}(1 + d_i f_i) \end{cases} \quad (5)$$

with $\|f_i(t)\| \leq 1$ where d_i indicates the deviation magnitude of the stiffnesses coefficients from their nominal values C_{fi0} and C_{ri0} . By considering (1, 2, 4, 5), the uncertain T-S fuzzy model of the lateral vehicle dynamics is obtained as

$$\begin{aligned} \dot{x}(t) &= \sum_{i=1}^2 h_i(\alpha_f) ((A_i + \Delta A_i)x(t) + B M_z(t) + B_{fi} \delta_f(t)), \\ z(t) &= \sum_{i=1}^2 h_i(\alpha_f) C_{1i} x(t), \\ y(t) &= \sum_{i=1}^2 h_i(\alpha_f) ((C_{2i} + \Delta C_i)x(t) + D_i \delta_f(t)) \end{aligned} \quad (6)$$

where $x = [v \ r]^T$, $y = [a_y \ r]^T$, $z = r$

$z(t)$ is the controlled output vector and $y(t)$ is the output vector of the system, ΔA_i and ΔC_i represent parametric uncertainties with appropriate dimensions.

$$A_i = \begin{bmatrix} -2 \frac{C_{fi} + C_{ri}}{mu} & -2 \frac{C_{fi} a_f - C_{ri} a_r}{J} - u \\ -2 \frac{C_{fi} a_f - C_{ri} a_r}{J} & -2 \frac{C_{fi} a_f^2 + C_{ri} a_r^2}{J} \end{bmatrix},$$

$$B_{fi} = \begin{bmatrix} 2 \frac{C_{fi}}{mu} \\ 2 \frac{a_f C_{fi}}{J} \end{bmatrix}, B = \begin{bmatrix} 0 \\ 1 \\ J \end{bmatrix}, D_i = \begin{bmatrix} 2 \frac{C_{fi}}{m} \\ 0 \end{bmatrix},$$

$$C_{1i} = [0 \ 1], C_{2i} = \begin{bmatrix} -2 \frac{C_{fi} + C_{ri}}{mu} & -2 \frac{C_{fi} a_f - C_{ri} a_r}{mu} \\ 0 & 1 \end{bmatrix},$$

we assume that the uncertainties can be formulated as follows

$$\Delta A_i = D_{Ai} F_i(t) E_{Ai}, \quad \Delta C_i = D_{Ci} F_i(t) E_{Ci} \quad (7)$$

where $F_i(t), i = 1, 2$ are matrices uncertain parameters such that $F_i(t)^T F_i(t) < I, i = 1, 2$. I is the identity matrix of appropriate dimension. E_{Ai}, E_{Ci}, D_{Ai} and D_{Ci} are known real matrices of appropriate dimensions that characterize the structures of uncertainties.

3. H_∞ FUZZY OBSERVER BASED CONTROLLER DESIGN

In this section, stability conditions formulated in LMI constraints that guarantee the stability of the uncertain T-S fuzzy model (6) with H_∞ disturbance attenuation γ are presented.

The structure of the fuzzy output feedback controller is given as

$$M_z(t) = \sum_{i=1}^2 h_i(\alpha_f) K_i \hat{x}(t), \quad (8)$$

where $\hat{x}(t) \in \mathbb{R}^2$ is the estimated state and $K_i \in \mathbb{R}^{1 \times 2} (i = 1, 2)$ are the controller gains to be determined. The proposed fuzzy observers for the uncertain T-S fuzzy system (6) is as follows (9)

$$\begin{aligned}\dot{\hat{x}}(t) &= \sum_{i=1}^2 h_i(\alpha_f)(A_i \hat{x}(t) + B M_z(t) + B_{f_i} \delta_f(t) \\ &\quad - G_i(y(t) - \hat{y}(t))), \\ \hat{y}(t) &= \sum_{i=1}^2 h_i(\alpha_f)(C_{2i} \hat{x}(t) + D_i \delta_f(t))\end{aligned}\quad (9)$$

where $\hat{y}(t) \in \mathbb{R}^{2 \times 1}$ is the estimated output. $G_i \in \mathbb{R}^{2 \times 2}$ ($i = 1, 2$) are the observer gains to be determined to satisfy $x(t) - \hat{x}(t) \rightarrow 0$ exponentially as $t \rightarrow \infty$.

The global asymptotic stability of the uncertain T-S fuzzy model (6) is summarized in the following theorem :

Theorem 1. For a given positive number $\gamma > 0$, some positive scalars $\alpha, \epsilon_{2ij}, \epsilon_{3ij}, \epsilon_{4ij}, \epsilon_{5ij}$. If there exist matrices $Z > 0, Y > 0, M_i, J_i, Z_{ij}$ and a positive scalars $\epsilon_{1ij}, \epsilon_{6ij}$ with $Z_{ji} = Z_{ij}^T$ satisfying the following LMI

$$\begin{pmatrix} \Theta_{ii} & \Lambda_{ii} \\ * & \Psi_{ii} \end{pmatrix} < Z_{ii} \quad i = 1, 2 \quad (10)$$

$$\begin{pmatrix} \Theta_{ij} + \Theta_{ji} & \Lambda_{ij} + \Lambda_{ji} \\ * & \Psi_{ij} + \Psi_{ji} \end{pmatrix} < Z_{ij} + Z_{ji} \quad i < j \quad (11)$$

$$\begin{pmatrix} Z_{11} & \cdots & Z_{1r} & V_{1k}^T \\ \vdots & \ddots & \vdots & \vdots \\ Z_{r1} & \cdots & Z_{rr} & V_{rk}^T \\ V_{1k} & \cdots & V_{rk} & -I \end{pmatrix} < 0, \quad k = 1, 2 \quad (12)$$

$$\text{with} \quad V_{ik} = (C_{1i} \ 0) \quad (13)$$

where $\Theta_{ij}, \Lambda_{ij}$ and Ψ_{ij} are given in 17, 18 and 19 respectively.

Then H_∞ control performance is guaranteed for the fuzzy model (6) via the fuzzy observer-based controller (8) where $K_i = M_i Z^{-1}$ and $G_i = Y^{-1} J_i$

Proof : See Oudghiri et al (2007a). These conditions allow to determine in one step the controller and the observers gains Oudghiri et al (2007a).

4. THE FTC SCHEME

The method of Fault Tolerant Control (FTC) that we propose is based on a FDI functional block which uses a bank of two observers each utilizing a different output measurement to estimate the vehicle states (figure 1). Before giving the control strategy, let us considering the following assumptions

- Let C_i^l ($i, l = 1, 2$) denotes the l^{th} row of matrix C_i .
- Sensor failures are modeled as additive signals to sensors outputs

$$y(t) = \sum_{i=1}^2 h_i(\alpha_f)((C_{2i} + \Delta C_i)x(t) + D_i \delta_f(t)) + Ff(t) \quad (14)$$

where F represent a distribution matrix and $f(t)$ represents (additive) sensor faults and indicates which of the sensor providing measurements are prone to possible faults. It is defined as follows

$$\begin{aligned}\text{For failure of sensor 1} \quad F &= (1 \ 0)^T \\ \text{For failure of sensor 2} \quad F &= (0 \ 1)^T\end{aligned}$$

- we also assume that at any time at most one sensor fails. This assumption is guaranteed by the two possible values of the matrix F .

4.1 Observer Bank Design

The observer design scheme presented in the previous section is applied to the design of two observers. Observer 1 uses the lateral acceleration a_y and the observer 2 uses the yaw rate r . Both observers estimate the two states of the model.

The schematic of the FTC strategy is given in figure 1. Here, note that the ' $\hat{\cdot}$ ' denotes estimate and '1' or '2' subscript denotes the estimate from the first or the second observer.

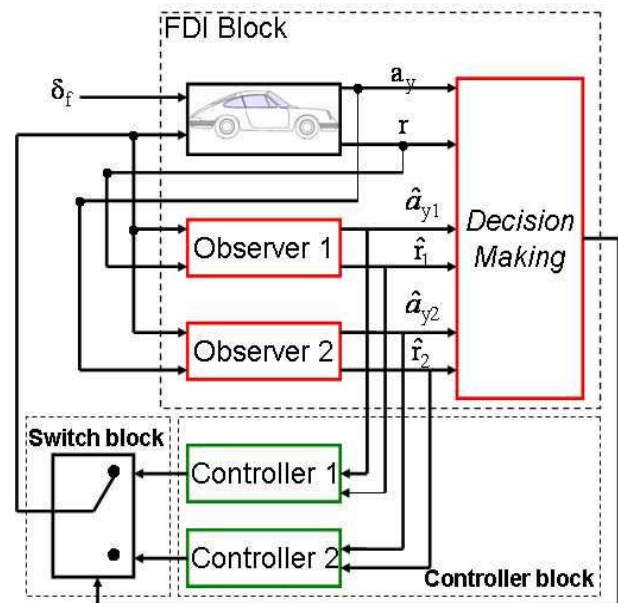

Fig. 1. Block diagram of the observer-based FTC

The structure of the observer 1 is given as :

$$\begin{aligned}\dot{\hat{x}}_1(t) &= \sum_{i=1}^2 h_i(\alpha_f)(A_i \hat{x}_1(t) + B M_z(t) + B_{f_i} \delta_f(t) \\ &\quad - G_i^1(a_y(t) - \hat{a}_{y1}(t))), \\ \hat{a}_{y1}(t) &= \sum_{i=1}^2 h_i(\alpha_f)(C_{2i}^1 \hat{x}_1(t) + D_i^1 \delta_f(t))\end{aligned}\quad (15)$$

The structure of the observer 2 is given as :

$$\begin{aligned}\dot{\hat{x}}_2(t) &= \sum_{i=1}^2 h_i(\alpha_f)(A_i \hat{x}_2(t) + B M_z(t) + B_{f_i} \delta_f(t) \\ &\quad - G_i^2(r(t) - \hat{r}_2(t))), \\ \hat{r}_2(t) &= \sum_{i=1}^2 h_i(\alpha_f)(C_{2i}^2 \hat{x}_2(t) + D_i^2 \delta_f(t))\end{aligned}\quad (16)$$

where C_{2i}^l and D_i^l are the l^{th} rows of the matrices C_{2i} and D_i respectively and G_i^l ($i, l=1, 2$) are the constant observers gains to be determined.

We assume that all pairs $(A_i, C_i^{1,2})$ are observable, which are necessary conditions to estimate the state through either the first output a_y or the second one r .

4.2 FDI Block Design

Residuals are generated by comparing the estimates with the measured values for the sensor outputs. Table 1 lists the generated residuals.

Variable	Residual 1	Residual 2
Lateral acceleration	$R_{1,ay} = \hat{a}_{y1} - a_y$	$R_{2,ay} = \hat{a}_{y2} - a_y$
Yaw rate	$R_{1,r} = \hat{r}_1 - r$	$R_{2,r} = \hat{r}_2 - r$

Table 1. List of generated residuals

From these residuals, the presence or absence of a particular fault can be deduced using the following rules.

- (i) Only one fault is present at any time.
- (ii) If a sensor is faulty all estimates from the observer using the same sensor are affected.

From the above rules the following logic table (Table 2) is constructed to identify the fault. Note that in the second column of the table, elements values of the residual vector are denoted by '1' and '0's; the ones denoting non-zero elements and the zeros denoting elements whose value is zero.

Fault	$[R_{1,ay} \ R_{2,ay} \ R_{1,r} \ R_{2,r}]$
Lateral acceleration sensor	[1 1 1 0]
Yaw rate sensor	[0 1 1 1]

Table 2. Logic Table for Fault Isolation

After detecting the faulty sensor, we use a switcher to choose the good controller by applying the following rules :

if sensor 1 fails then

$$M_z(t) = \sum_{i=1}^2 h_i(\alpha_f) K_i^1 \hat{x}_1(t)$$

if sensor 2 fails then

$$M_z(t) = \sum_{i=1}^2 h_i(\alpha_f) K_i^2 \hat{x}_2(t)$$

where $\hat{x}_1(t)$ and $\hat{x}_2(t)$ are given by (15) and (16). The bloc diagram of the observer-based FTC is given in figure 1.

5. NUMERICAL ILLUSTRATIONS

To show the effectiveness of the vehicle sensor FTC designed in this study, we have carried out some simulations. In the design, the nominal stiffness coefficients and the parameters of the vehicle considered are given in the following tables :

Nominal stiffness coefficients	C_{f1}	C_{f2}	C_{r1}	C_{r2}
Values	60712	4812	60088	4555

Table 3. Nominal stiffness coefficients

Parameters	J	m	a_f	a_r	u
Values	3000	1500	1.3	1.2	20

Table 4. Vehicle parameters

By solving the LMIs given in theorem 1 , we obtain the following controller and observer gains

$$K_1^1 = 10^3 \begin{bmatrix} -0.5483 & -6.4169 \end{bmatrix}, K_2^1 = 10^3 \begin{bmatrix} 0.7802 & -6.4249 \end{bmatrix}$$

$$K_1^2 = 10^3 \begin{bmatrix} -0.5535 & -6.4097 \end{bmatrix}, K_2^2 = 10^3 \begin{bmatrix} 0.7832 & -6.4280 \end{bmatrix}$$

$$G_1^1 = \begin{bmatrix} -6.4547 \\ -16.3823 \end{bmatrix}, G_2^1 = \begin{bmatrix} -6.5373 \\ -19.5597 \end{bmatrix}$$

$$G_1^2 = \begin{bmatrix} 15.2767 \\ 7.6614 \end{bmatrix}, G_2^2 = \begin{bmatrix} 20.4305 \\ -0.0279 \end{bmatrix}$$

All the simulations are realized on the nonlinear model given in (1) with the following consideration:

- Vehicle speed: $20 \text{ ms}^{-1} \leq u \leq 30 \text{ ms}^{-1}$
- Adhesion coefficient: $0.4 \leq \mu \leq 1$
- Front wheel steer angle (rad): $-0.06 \leq \delta_f \leq 0.06$

The additive signals representing failures, added to output sensors, have the following expression

$$f(t) = \begin{bmatrix} f_1(t) \\ f_2(t) \end{bmatrix} = \eta \begin{bmatrix} a_y(t) \\ r(t) \end{bmatrix}$$

From figure 2 to figure 5, we can note that without application of the proposed FTC strategy, when sensors faults occur (in sensor 1 between 2s and 8s, in sensor 2 between 12s and 18s), the vehicle lost their performances. In figure 6 and figure 7, with the same steering pad maneuvers (upper curve), by using the proposed FTC strategy, we can remark that not only the vehicle remains stable but also the real and the estimated vehicle state variables are superposed. These simulation results (figure

6 and figure 7) prove the effectiveness of the proposed FTC strategy and the robustness of the designed law control.

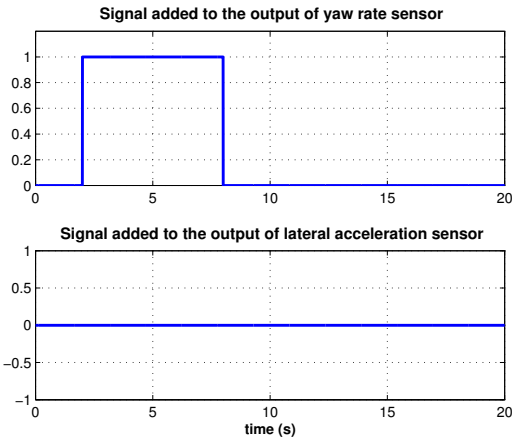

Fig. 2. Failures of sensors

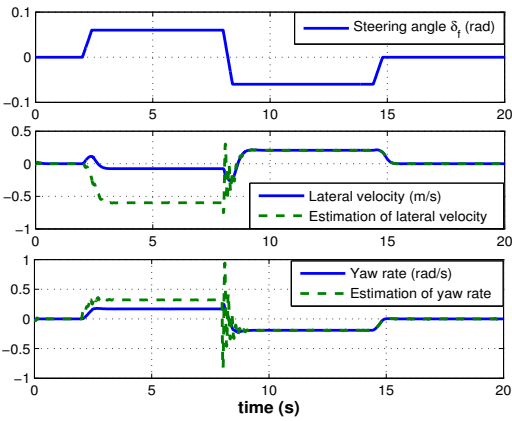

Fig. 3. Vehicle response without FTC strategy when sensor 1 is faulty and sensor 2 is healthy

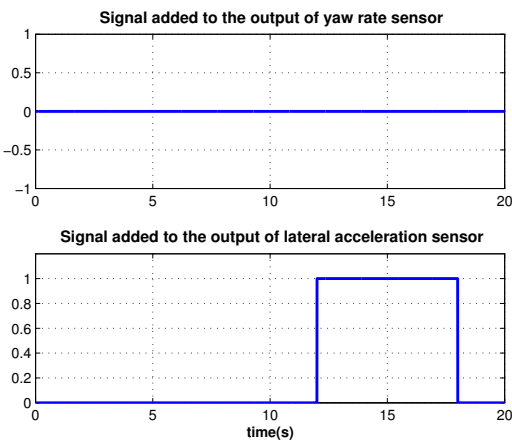

Fig. 4. Failures of sensors

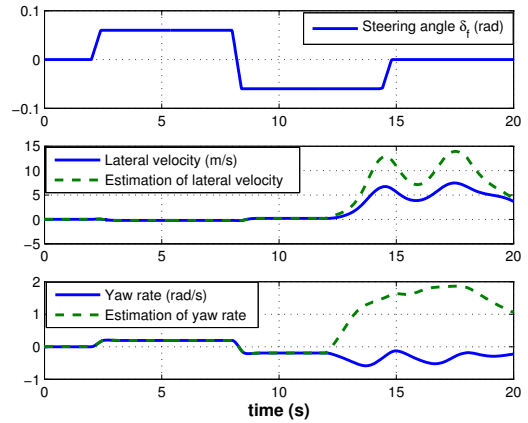

Fig. 5. Vehicle response without FTC strategy when sensor 1 is healthy and sensor 2 is faulty

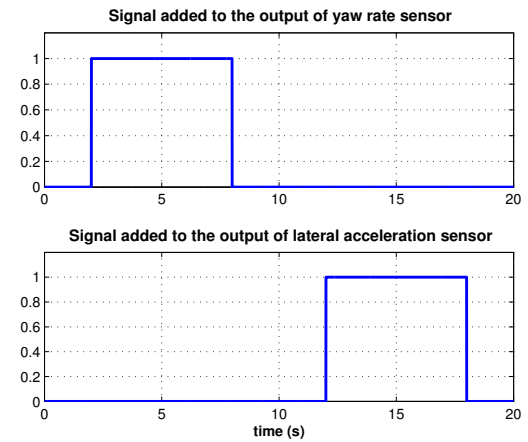

Fig. 6. Failures of sensors

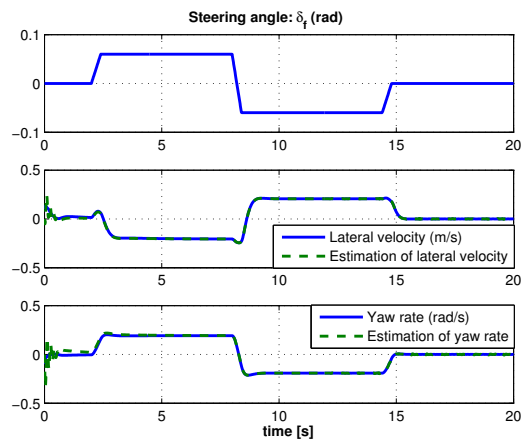

Fig. 7. Vehicle response with FTC strategy when sensor 1 and sensor 2 are faulty. Initial conditions: $x(0) = (0.1 \ -0.1)^T$, $\hat{x}(0) = (0 \ 0)^T$

$$\Theta_{ij} = \begin{pmatrix} (ZA_i^T + M_j^T B_i^T) + (*)^T + \rho^{-2} B_{1i} B_{1i}^T & ZE_{Ai}^T & M_j^T E_{Bi}^T & ZD_{Bi} & ZE_{Ai}^T & M_j^T E_{Bi}^T & ZE_c^T \\ +\epsilon_{1ii} D_{Ai} D_{Ai}^T + \epsilon_{6ij} D_{Bi} D_{Bi}^T & -\epsilon_{1ii} I & 0 & 0 & 0 & 0 & 0 \\ E_{Ai} Z & 0 & -\epsilon_{2ij}^{-1} I & 0 & 0 & 0 & 0 \\ E_{Bi} M_j & 0 & 0 & -\epsilon_{2ij} I & 0 & 0 & 0 \\ D_{Bi}^T Z & 0 & 0 & 0 & -\epsilon_{4ii}^{-1} I & 0 & 0 \\ E_{Ai} Z & 0 & 0 & 0 & 0 & -\epsilon_{3ij}^{-1} I & 0 \\ E_{Bi} M_j & 0 & 0 & 0 & 0 & 0 & -\epsilon_{5ii}^{-1} I \\ E_C Z & 0 & 0 & 0 & 0 & 0 & -\epsilon_{5ii}^{-1} I \end{pmatrix} \quad (17)$$

$$\Lambda_{ij} = \begin{pmatrix} B_{2i} M_j & 0 \\ 0 & 0 \end{pmatrix} \quad (18)$$

$$\Psi_{ij} = \begin{pmatrix} -2\alpha Z & M_j^T E_{Bi}^T & \alpha I & 0 & 0 & 0 & 0 & 0 \\ E_{Bi} M_j & -\epsilon_{3ij}^{-1} I & 0 & 0 & 0 & 0 & 0 & 0 \\ E_{Bi} M_j & 0 & -\epsilon_{6ij} & 0 & 0 & 0 & 0 & 0 \\ \alpha I & 0 & 0 & A_i^T Y + C_{2j}^T J_i^T + Y A_i + J_i C_{2j} & Y D_{Bi} & Y D_{Ai} & Y D_{Bi} & J_i D_c \\ 0 & 0 & 0 & D_{Bi}^T Y & -\epsilon_{3ij} I & 0 & 0 & 0 \\ 0 & 0 & 0 & D_{Ai}^T Y & 0 & -\epsilon_{4ii} I & 0 & 0 \\ 0 & 0 & 0 & D_{Bi}^T Y & 0 & 0 & -\epsilon_{3ij} I & 0 \\ 0 & 0 & 0 & D_c^T J_i^T & 0 & 0 & 0 & -\epsilon_{5ii} I \end{pmatrix} \quad (19)$$

6. CONCLUSIONS

This paper proposes a method based on a bank of two observers for fault-tolerant control of vehicle lateral dynamics. The chosen vehicle model is a frontwheel steered bicycle model with tire cornering stiffness assumed to be uncertain. Two robust fuzzy H_∞ observer-based controllers are developed based on two measurements output. Based on a FDI block, which analyzes different residuals, sensors failures are detected and isolated. By using a switch block, we select the good controller for maintaining the stability and nominal performances in spite of presence of sensors faults. The FTC scheme is validated using vehicle nonlinear model and taking account uncertainties (for example variation of road adhesion conditions and longitudinal velocity).

REFERENCES

E. Bakkern L. Linder, H. B. Pacejka. A new tyre model with an application in vehicle dynamics studies. *SAE*, vol.98, N.6, pp.101-113, 1989.
 M. Chadli, A. Elhajjaji. Observer-based robust fuzzy control of nonlinear systems with parametric uncertainties. *Fuzzy Sets and Systems Journal*, vol.157(9), pp.1276-1281, 2006.
 M. Chadli, A. Elhajjaji, M. Oudghiri. Robust Output Fuzzy Control for Vehicle Lateral Dynamic Stability Improvement. *International Journal of Modelling, Identification and Control*, vol.3, 2006, in press.
 M. Oudghiri, M. Chadli, A. Elhajjaji. One-Step Procedure for Robust Output H_∞ Fuzzy Control. *The 15th Mediterranean Conference on Control and Automation-MED'07*, pp.1-6, June 27-29, 2007.
 M. Oudghiri, M. Chadli, A. Elhajjaji. Observer-based fault tolerant control for vehicle lateral dynamics. *European Control Conference*, pp.632-637, Kos, Greece 2-5 July 2007, 2007.

S. Boyd. L. El Ghaoui. E. Feron and V. Balakrishnan. Linear matrix inequalities in systems and control theory. *Philadelphia, PA: SIAM*, 1994.
 K. Tanaka and O. Wang. Fuzzy Regulators and Fuzzy observers: A linear Matrix Inequality Approach. *Proceeding of 36 th IEEE CDC*, pp.1315-1320, 1998.
 P. Korba, R. Babuska, H. B. Verbruggen and P. M. Frank. Fuzzy Gain Scheduling: Controller and Observer Design Based on Lyapunov Method and Convex Optimization. *IEEE Transactions on Fuzzy Systems*, Vol.11, N.3, pp.285-298, June 2003.
 K. Kim, J. Joh, R. Langri and K. Kwon. LMI-Based Design of Takagi-Sugeno Fuzzy Controllers for Nonlinear Dynamic systems using fuzzy estimators. *Inter. Jour. of Fuzzy Systems*, vol. 1(2), pp.133-144, 1999.
 R. Isermann. Diagnosis methods for electronic controlled vehicles. *Vehicle System Dynamics*, vol. 36, N. 2-3, pp. 77-117, 2001.
 S. X. Ding, S. Schneider, E. L. Ding, and A. Rehm. Advanced model-based diagnosis of sensor faults in vehicle dynamics control systems. *IFAC, 16th Triennial World Congress*, Prague, Czech Republic, 2005.
 M. Blanke, M. Kinnaert, J. Lunze, and M. Staroswiecki. Diagnosis and Fault tolerant Control. *Springer*, 2003.