

## Influence of the time step in ANN modelling of thermal stratification of solar storage

P. Géczy-Víg and I. Farkas

*Department of Physics and Process Control, Szent István University  
Gödöllő, Páter K. u. 1., H-2103 Hungary,  
Tel.: +36 28 522055, Email: Farkas.Istvan@gek.szie.hu*

---

**Abstract:** In the present work an artificial neural network (ANN) model is introduced which was elaborated for modelling the layer temperatures in a storage tank of a solar thermal system. The model calculates the temperatures of 8 equal layers of the storage tank in several time interval from the average time interval data of the solar radiation, the water consumption, the ambient temperature, the mass flow rate of collector loop and the temperature of the layers in the previous time-step. The used time intervals are one hour, 30, 10, 5, 2 and 1 minutes. The introduced ANN model is convenient for describing the system in every case, and the identified models give acceptable results inside the training interval. The average deviation was 0.53 °C during the training and 0.76 °C during the validation in case of hourly data and these data were 0.07 °C and 0.08 in case of 1 minute time interval. The optimal time interval was found at 5 minutes.

---

### 1. INTRODUCTION

To use of solar energy by flat plate collectors is spread in a fairly wide range in agriculture as hot water water supply, heating of animal buildings and crop drying. Additionally, it is also a common use for the domestic hot water supply along with some storage possibility. The knowledge about the solar thermal systems can be taken into consideration for the design, operation and control processes of the further systems.

Recently the examination of such systems by neural networks is happened too. Kalogirou et al. (1999) determined an ANN model, which gives prediction of the average temperature of stored water in the solar storage tank. Data of 30 solar systems were used during the modelling.

Kalogirou and Panteliou (2000) gave the long-term performance prediction of the thermosiphon solar domestic water systems with ANN. The results of their models give acceptable accuracy prediction for design and sizing of these systems.

The well working physically based model gives simply data in several time intervals. The aim of the present work is to examine what is the behavior of the developed ANN of the system in case of several time intervals in the base of the data measured at the same time as the modeling. These intervals are 1 hour, 30, 10 and 1 minutes.

The conclusions about the behavior of the validated artificial neural network models are deduct from the values of the measured and ANN generated data in case of the same validation sets.

From the ANN it was expected to give prediction to the layer temperatures of the storage tank in every time interval from the average time interval data of the water consumption, the solar radiation, the ambient temperature, the mass flow rate of the collector loop and the previous temperature of the layers.

The heat storage tank of the solar heating systems is usually not stratified although it would be ideal from the point of view of energy storage and use. In our case for achieving perfect stratification for the storage of the domestic system a special inside heat exchanger was developed. Therefore this storage is considered to be stratified.

From the data of the layer temperatures conclusions may be drawn for the available energy, so this data are usable for sizing of the solar thermal system.

### 2. DESCRIPTION OF THE SYSTEM

The studied system was installed at the Department of Physics and Process Control, Szent István University, Gödöllő, Hungary. This domestic sized system serves for the needs of the hot water consumption. The main parameters of the system are as follows:

The flat plate collector (see in Fig. 1) absorber area is 1.65 m<sup>2</sup>, along with south orientation and 45° inclination angle. The solar fluid is mixture of polypropylen-glicol and water in 50-50%.



Fig. 1. The collector part of the system

Solar storage (see in Fig. 2) has no electrical heater, the volume is 0.15 m<sup>3</sup>.



Fig. 2. The solar storage tank

For more efficient realization of the stratification a special internal heat exchanger was installed inside the tank. The parameters of the heat exchanger are detailed in Fig. 3.

The warm water flows to the upper layer of the storage tank across a bottle-neck which was insulated inside.

The working pump produces the volume flow rate of 0.216 m<sup>3</sup>/h in the collector loop if the difference between the outlet temperature of the collector and the bottom of the tank is larger than 5 °C.

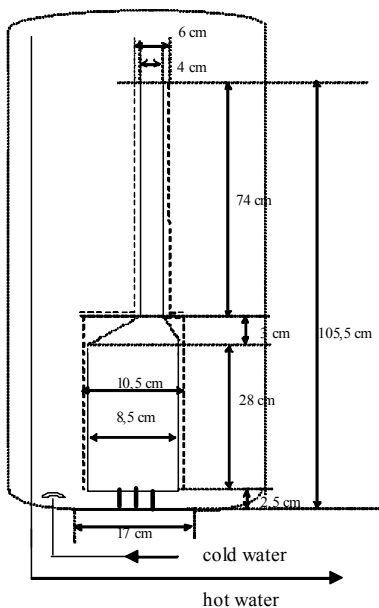

Fig. 3. Scheme of the internal heat exchanger

### 3. DATA USED FOR MODELLING

For the ANN modeling adequate quantity of data rows are necessary as the behavior of the system is trained by these data. The data gathering was happened from July 5 to December 22 in 2006. For the modeling the following data were used:

Meteorological data: solar radiation and ambient temperature were measured by the meteorological station installed on the spots every minute. Average time interval data were calculated from these data.

The pyranometer which measure the total radiation is installed in the plane of the collector, above it. The ambient temperature is measured behind of collector with PT100 resistance thermometer.

Water consumption: hourly data, mainly daytime between 0 and 60 liters.. The water consumption is happened with 10 liter/min volume flow rate manually.

The temperatures of the used hot water and the cold water coming to the storage were measured during the consumption.

The measurements of the temperature distribution in the stored water were realized in eight locations along the height of the tank in equal distribution with thermocouples.

The ambient temperature of storage tank, the temperature of solar fluid entering and leaving the collector were measured every minute, too.

The measurement layer temperatures are shown in Figs 4, 5 and 6 in one day period, where *m1* is the bottom layer and *m8* is the upper layer temperature.

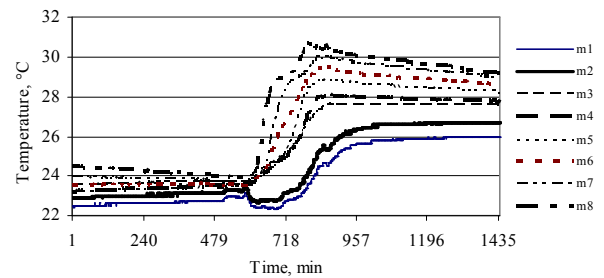

Fig. 4. Layer temperatures on November 18, 2006, without water consumption

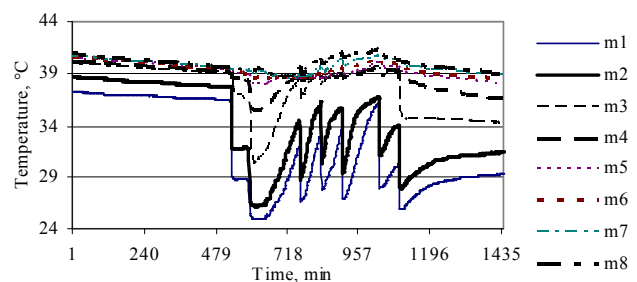

Fig. 5. Layer temperatures on August 17, 2006, with 7x20 l water consumption

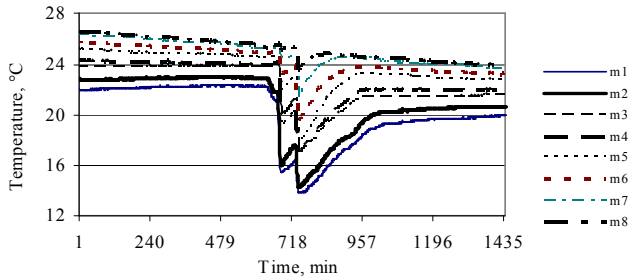

Fig. 6. Layer temperatures on October 20, 2006, cloudy day, with 2x50 l water consumption

#### 4. ANN MODELLING

The aim was to give an ANN model, which describes the thermal stratification in the solar storage with good accordance and simple way. The steps of the ANN modeling are structure design, training and validation (Farkas 2003).

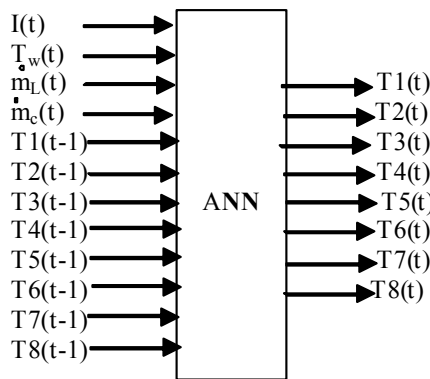

Fig. 7. Inputs and outputs of the ANN model

The temperatures of the cold water and the ambient of the storage tank do not change essentially therefore these are not used as inputs.

The inputs and outputs of the model can be seen in Fig. 7 where  $I(t)$  is the solar radiation,  $T_w(t)$  the ambient temperature,  $\dot{m}_L(t)$  and  $\dot{m}_c(t)$  the mass flow rate of the water consumption (load) and collector.  $T1(t), \dots, T8(t)$  are the average layer temperatures in the  $t$ -th time interval, and  $T1(t-1), \dots, T8(t-1)$  average layer temperatures in the previous,  $(t-1)$ -th time interval.

##### 4.1. Structure design

The ANN model was determined (Géczy-Víg and Farkas, 2006) by the MATLAB Neural Network Toolbox (MathWorks, 2001).

Among several ANN models a two layer network model, which contains 8 tansig neurons in the hidden layer and 8 linear neurons in the output layer gave good accordance and was simple enough. The described structure for the thermal stratification of solar tank is shown in Fig. 8. The notation is the same as the notation of Fig. 7.

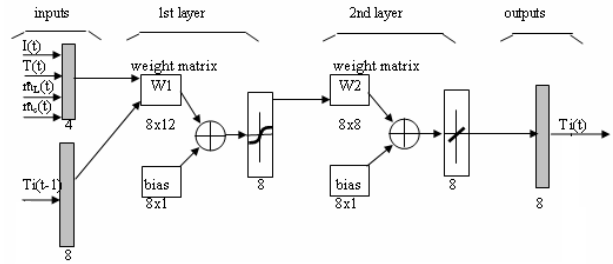

Fig. 8. The descriptor ANN structure

##### 4.2. Trainings

During the trainings the Levenberg-Marquardt training algorithm was used for every case. At the identification processes the random weight and bias values were changed to minimize the error between the measured layer temperatures and generated by ANN by the method of least squares.

At the training measured data of 116 days were used. In the first column of Table 1 give sizes of training set and the second column gives the average deviation between the measured layer temperatures and generated with ANN during the training in case of several time interval.

Table 1. Average deviation values

time interval	training set [data rows]	training result [°C]	validation result [°C]
1 hour	2526	0.53	0.76
30 minutes	5084	0.46	0.63
10 minutes	15215	0.29	0.39
5 minutes	30934	0.22	0.26
2 minutes	77180	0.13	0.14
1 minute	153859	0.07	0.08

In Fig. 9 the results of training in a four days interval are shown.

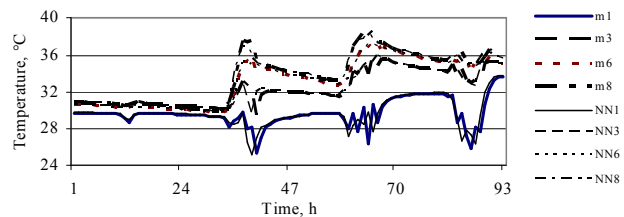

Fig. 9. Results during the training for August 7-10, 2006 in case of 1 hour time interval

##### 4.3. Validation

During the validation 8 days data were used. The results of validation are presented in the 3th column of Table 1. The results in a 2 days period are shown in Fig. 10 in case of one hour time interval.

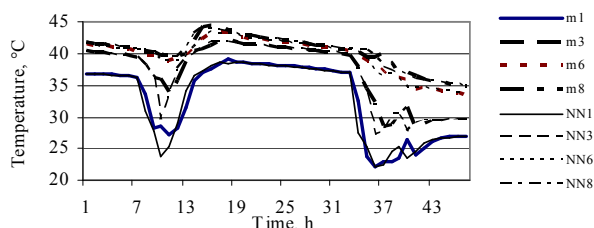

Fig. 10. The result of validation for September 26-27, 2006

The conditions are shown in Fig. 11.

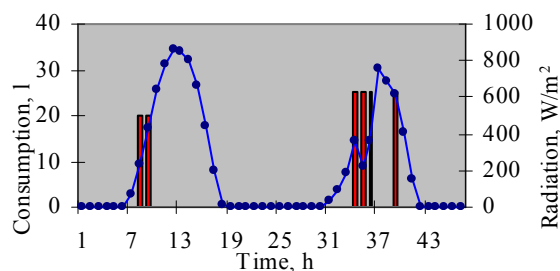

Fig. 11. Conditions of the validation

The data of the solar radiation (solid-line) and temperature were measured, the consumption data (column) are similar to that were used during the training. For the better visualization only the upper top and two middle layers are graphed for the results. *NN1*, *NN3*, *NN6* and *NN8* are the ANN generated layer temperatures in the top a two middle and bottom layers *m1*, *m3* *m6* and *m8* are the measured layer temperatures in the adequate layers.

## 5. RESULTS AND CONCLUSIONS

- The introduced ANN model is convenient for describing the thermal stratification of the system.
- The results of the training and the validation (square root of the average square deviation), are presented in Table 1.
- The optimal time interval was identified at 5 minutes. This time is sufficient for follow the change of the weather. The time constant of the collector and heat inertia of the thermocouples were also taken into account in describing the thermal stratification.
- The identified models give acceptable results from the point of view of engineering practice inside the training interval.
- A well worked ANN model is also able to give predictions of data-rows in several time steps if it was trained that.
- The next task is to simulate the layer temperatures with the validated ANN models in case of real consumption data. Comparing the measured, the ANN generated and the physically based model generated data is also an important task.

- The use of measured data of further months during the training gives the possibility of generalization of the model.
- As the consumptions until now were rarely, only in the daytime and in hourly rate, measured data gathering from more frequent and precise consumption are necessary to collect for the refinement of the model.

## ACKNOWLEDGEMENTS

The work was carried out within the project of OTKA K 69094.

## REFERENCES

- Farkas, I. and Géczy-Víg, P. (2003): Neural network modelling of flat-plate solar collectors, *Computers and Electronics in Agriculture*, Vol. 40., No. 1-3. pp. 87-102.
- Géczy-Víg, P. and Farkas, I. (2006): Modelling of heat storage of solar thermal system with neural network, *Hungarian Agricultural Engineering*, 19/2006, pp. 71-73.
- Kalogirou, S.A. et al. (1999): Modeling of solar domestic water heating system using artificial neural networks. *Solar Energy*, 65 (6), pp. 335-342.
- Kalogirou, S.A. and Panteliou, S. (2000): Termosiphon solar domestic water heating systems: long-term performance prediction using artificial neural networks. *Solar Energy*, 69 (2), pp. 163-174.
- MathWorks (2001), Neural Network Toolbox for use with MATLAB, User's Guide, MathWorks, Inc.