

## TARASHT POWER PLANT PC-BASED SIMULATOR IMPLEMENTATION TURBINE CASE STUDY

**Alireza Yazdizadeh**

*Power and Water University of Technology  
P. O. Box 16765-1719  
Tehran, Iran  
alireza@pwut.ac.ir*

**Abstract:** Economical operation of large scale systems like a power plant depends on the plant operators and their skills. There are some specific training courses which are presented by experts for the operators, but the operators need to experience in their own way. A methodology for increasing skills of the operators with less cost is to use power system simulators. The TARASHT power plant simulator has been designed and manufactured by Mitsubishi Heavy Industry Group based on a DEC VAX 4000 mini-computer. In a research work supported by the industry, a pc-based simulator was redesigned by Power and Water University of Technology (PWUT). In this paper the result of the project is presented. *Copyright © 2002 IFAC*

**Keywords:** Modelling, Simulation, Operation and Control of Power Systems

### 1. WHY SIMULATOR?

Economical operation of power systems (power plants, transmission lines and equipments, distribution systems) is very important. Quality performance and operation is highly dependent on operators in industry. Although operators are trained at the beginning of hiring and during career by on job training, they also need to achieve some experiences that can not be conveyed to them by traditional methods. In other words, operators need to know how to operate the plant under different conditions especially in emergency cases. There are some specific training courses which are presented by experts for the operators, but the operators need to experience in their own way. These experiences are achieved either by experiencing in a real fault or trip or by working with simulators in a virtual environment [Yazdizadeh, 1990]. The cost of two above mentioned methods are not comparable. By training the operators over a simulator, power plant manager can be sure that his personnel are ready for any emergency condition and they can manoeuvre and operate the plant in a very safe and cost-less manner. Power system simulators can simulate different circumstances and show the effects of any action during operation. By working with simulators, operators can achieve different experience without

affecting the main system. Operators, themselves, like to work with power plant simulator so that they can experience what they have never seen in real operation during their career. Therefore, there is an intention to send the personnel for training simulator short courses in industry but due to the cost of these courses, these programs are ignored in most of the time. This kind of simulators (large scale systems simulator) are usually designed and manufactured by the large companies that supply the main systems. Due to the complexity of different mechanical, electrical, control and other processes in power plants, a mini-computer is usually used as the platform for implementation of the simulators. The main idea of the research work done by PWUT is to redesign and implement a similar advance simulator manufactured by Mitsubishi Heavy Industry Group for TARASHT Power Plant. In this work different parts of the main simulator is analyzed and the equivalent part based on a Pentium-PC capability is redesigned and implemented. Analysis and realization of different equipments transfer function are among the other part of the project. The TARASHT power plant simulator has been designed and manufactured by Mitsubishi Heavy Industry Group based on a DEC VAX 4000 mini-computer with VMS operating system.

The main purpose of simulators is to simulate dynamic response of the system to different inputs. In reality it is very hard to produce the same response as the main system, therefore, in modelling and simulation, the goal is to minimize the identification error. A wide range of methods is used to identify and simulate a power plant, including analytical and intelligent methods [Yazdizadeh and Khorasani, 2001], [Yazdizadeh and et al., 2000], [Yazdizadeh and Khorasani, 1998]. Different phases of simulation done in this work are as follows:

- a) Goal definition,
- b) Data gathering and parameters estimation,
- c) Modelling (based on the physical characteristics of different part of the system and gathered data),
- d) Validation of the simulation results, and
- e) Result analysis for training or other purposes.

The main features of the designed simulators are as follows:

- a) Time extension and compression,
- b) Time pause and play,
- c) Safety in training,
- d) Self confidence in trainers.

The content of the paper is as follows: in section 2, TARASHT Power Plant Simulator is introduced, in section 3, the designed pc-based simulator is discussed and the conclusion is given in section 4.

## 2. TARASHT POWER PLANT SIMULATOR

There are just a few simulators in different industries in Iran. The only unique simulator in power industry in Iran has been designed and installed in TARASHT power plant. The simulator is made by Mitsubishi Heavy Industry Group according to a general and some specific characteristics of a steam power plant. Physical equipments and processes of the simulated power plant as well as Hardware/Software of the simulator are given in this section.

### 2.1 Physical Equipments and Processes of the Simulated Power Plant

The simulator is designed to simulate a 250 MW steam power plant that includes a boiler, a turbine and a wet cooling tower. For auxiliary steam, it is possible to extract steam from the main boiler or other units' boilers. Commissioning of the plant is undertaken by electricity which is supplied by the transmission lines connected to the power plant. The turbine is a condensate with re-heater working in 3000 rpm speed.

The main simulated processes are: make up water system, condensate water system, low and high pressure heater, vacuum system, de-aerating system, boiler valves, feed water system, boiler combustion system, boiler air and fuel system, auxiliary steam supply system.

Combustion control, air and fuel control, feed water pump speed control, main steam temperature control, re-heater and by-pass steam temperature control,

supervisory systems and alarm systems are among the simulated control loops and systems.

### 2.2 Simulator Hardware/Software

The simulator is consisted of five interconnected computers for performing the following tasks [MITSUBISHI, 2004]:

#### 2.2.1 Central Processing Unit

A DEC VAX 4000 mini-computer (model 300) supported with 32 MB main memory using VMS operating system is used as the main processor. The dynamic models of the above mentioned equipments, processes and control systems are run by the main processor. Other tasks like interrupt control and address translation are also done by the main processor.

#### 2.2.2 Instructor System

Instructor system is run via VT340 CRT console under DOS (Disk Operating System). Setting of the power plant parameters, setting of the critical and emergency situation data and other similar tasks are performed by this system.

#### 2.2.3 Data Acquisition System (DAS)

An operating station (240I) supported with 32 MB of memory under UNIX operating system is used for data acquisition. The main tasks of DAS are: supervision of the system, data gathering and recording the last changes in the parameters set, supervision of parameters changes trend and supervision of alarms.

#### 2.2.4 Maintenance Tools System

Similar to DAS, the maintenance tools system is simulated with an operating station (240I) supported with 32 MB of memory working under UNIX operating system. This section is used for dynamic model definition, control loops definition and correction of the models and control loops.

#### 2.2.5 DIASYS Control System

The DIASYS control system includes two separate modules. Each module performs as a node on the Ethernet network. The core system of each part is a 80386 pc supported with 1MB memory. The main task of this system is to communicate (Input and Output) with the field.

#### 2.2.6 Main Operation Desk (MOD)

Main desk of the simulator is consisted with different keys, displays, buttons, keyboards and monitors, all very similar to those of the main power plant. Main operation of the system like commissioning and handling of trips are simulated and controlled by the equipments installed on this desk. Different control loops and their function, electric and hydraulic control system, unit control system, furnaces control system, supervisory and alarm systems are simulated on this desk.

### 2.2.7 Sub-Operation Panel (SOP)

Monitoring of the power plant equipments as well as process diagrams are performed by SOP. The depicted diagrams on SOP are: water and steam cycle diagrams, air and exhaust gas diagrams, fuel diagram, cooling system diagram, vacuum equipments diagram, electricity and internal power supply diagram, make-up water system diagram and lubricating system of turbine diagram.

Data communication between input and output is locally performed by DIASYS-UP via a bus system and in a higher level is performed via an optical fibber ring. Figure-1 shows main parts of TARASHT power plant simulator. The figure also depicts how different parts are internally connected.

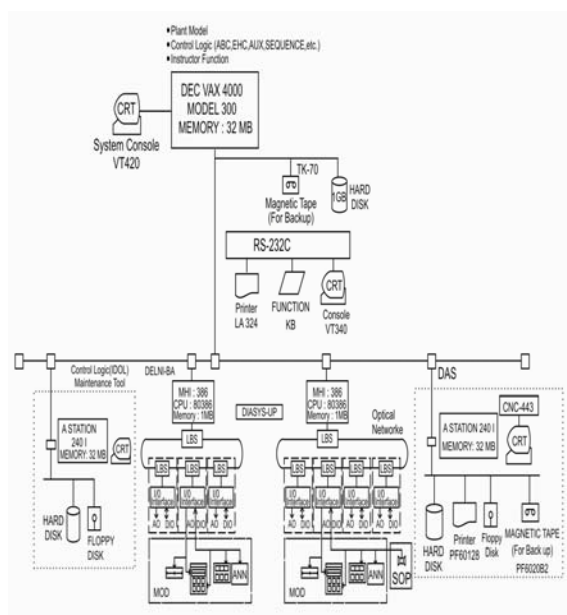

Figure-1 Main parts of TARASHT Power Plant Simulator

## 3. PC-BASED POWER PLANT SIMULATOR

TARASHT power plant simulator is manufactured based on a Mainframe network. In the designed simulator, we proposed a pc-based local area network. The network, of course, can be used over the internet for distant learning too. It is possible for the personnel of other plants to use the proposed simulator for training. In case of multi-user network, the system can be modified and developed by using several servers. Different aspects and features of the designed simulator is discussed in this section.

### 3.1 Simulator Hardware

To select a computer platform for simulating the steam power plant, the capabilities of a commercial Pentium IV pc is compared with the capabilities of the mini-computer used in TARASHT power plant, namely, a VAX 400-300. The comparison is performed under a standard test in a full star network

topology. Whetstone benchmark test [Web-DEC, 2005] is used and the result is shown in Table-1.

As shown in the table, different indices are introduced in order to fully compare different systems. A commercial Pentium IV system has the same computational capabilities as a VAX system for our application. It is worth noting that the price of a VAX 4000 (model 300) is much higher than a commercial Pentium IV pc.

A network of Pentium IV pc is used for different tasks including input output, modelling and other aforementioned part in the main system.

Manufacturer	System Models	Clock MHz	M WIPS	Meg. FLOPS	M WIPS	DP
Digital	VAX 4000-300	33.7	8.93	-	6.25	
Compaq	Pentium pro	200	144	53.8	-	
HP	Pentium	166	112	51.6	-	
HP	Pentium II	233	169	62.7	-	
Commercial PC	Pentium	120	79.5	20.2	81.6	
Commercial PC	Pentium II	266	218	55.3	226	
Commercial PC	Pentium III	450	367	93.5	379	
Commercial PC	Pentium IV	1900	671	168	670	

Table-1: Whetstone benchmark test

### 3.2 Simulator Software

Two main software were to be selected for realization of the designed simulator, namely, operating system and application software. These two parts are discussed in the following subsections.

#### 3.2.1 Operating System

A number of indices are considered while selecting an operating system for a specific application. Price, hardware support, simplicity of set up, reliability, failure recovery, security, being user friendly, maintenance issues, capability of development, system utilities and so on are among the different aspects to be taken into account. Having investigated the mentioned indices, Linux and Windows 2000 can be used for our application. Windows is selected as the operating system.

#### 3.2.2 Application Software

For the sake of simplicity and availability and also due to other suitable characteristics of MATLAB, this programming language was used for simulator

implementation. MATLAB as a total solution provides different facilities so that it can be considered as a candidate for simulator realization and other kind of engineering applications. Toolboxes, block sets, libraries and modification and development capabilities along with possibility of combinational use of MATLAB with C Language, Fortran, Java and other existing packages are among the other issues that ensures us about the capabilities of the MATLAB for our application. Therefore, MATLAB version 6.5, edition 13 under Windows 2000 server was selected as the application software in the project. Some capabilities of the designed simulator (based on MATLAB) are as follows:

- Graphic User Interface: GUI consists of combination of different objects such as windows, icons, key boards, menus and texts. By using GUI, one can create a very similar operation desk as the main simulator or the real plant, namely steam power plant.
- Switchyard Programming: By using this feature of MATLAB, it is possible to have access to all of the tools and data. One can also organize programming codes in M-files functions and scripts.
- Simulink: Simulink is a powerful software for modelling and simulating different dynamic blocks (transfer function or any other representation form of a dynamic system). Sources, sinks, linear and nonlinear blocks, differentiator and integrators in Simulink, provides a very useful environment for solving differential and difference equations. Simulink version 5 is used for modelling and simulating different equipments, processes and control loops of the steam power plant.
- Real Time Systems: In real time systems and simulations, it is very important to undertake the computational loops in a real time manner. Toward this, Real Time Windows Target is used for the simulator implementation. Having defined the analytical (mathematics) model of the main equipments of the power plant, different diagrams are produced by using state flow software. Application programs codes are generated by Real Time Workshop with a C-Language compiler.
- Run Time Server: By using the Run Time Server, there is no need for user to have access to the programs sources and therefore, the security of the system, to a considerable level, is guaranteed. Users do not need to know about different command and it is possible to produce stand-alone application programs. The server also provides an environment for establishing a computational engine that may use other languages like C, Visual Basic which is very useful for our application.
- Data Base Toolbox: Simulation of a large scale system such as a power plant requires a powerful data base, as there is a large amount of generated simulation data as well as information related to the topology of the plant and the measured or estimated parameters. By using this toolbox, one can realize the

Import/Export part of the simulator in a very well organized manner.

### 3.3 SIMULATOR MODELS

A variety of steam power plants models have been introduced in the literature [ORDYS, et al., 1994], [ANSI, 1993]. The models developed in previous work [MOKABERI, 2001] are used in this work. The models are suitable for realization by MATLAB and Simulink. It is impossible to represent schematics, block diagrams and dynamic equations of different parts of a steam power plant in this paper, however, a case study can show the proposed method for simulation of a power plant. We start with schematics of a turbine belonging to a steam power plant as shown in Figure-2.

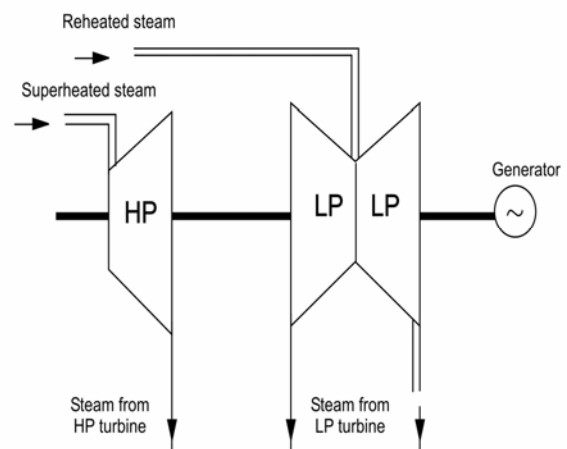

Figure-2 Turbine Schematic of a Power Plant.

The block diagram of the above schematic can be introduced based on the analysis of each main equipment. The block diagram is shown in Figure-3.

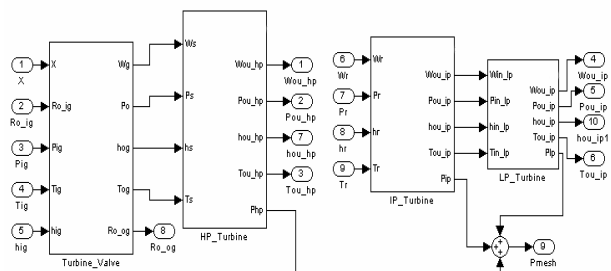

Figure-3 Block diagram of the turbine

As shown in the figure, there are four main parts, namely, Turbine Valve, HP-Turbine, IP-Turbine and LP-Turbine. In this section the governing equations of the HP-Turbine are given as follows:

$$\varphi = \frac{C_{php}}{C_{php} - R_{shst}}$$

$$h_o = \frac{X_o}{\rho_o}$$

$$T_{o-hp} = \frac{h_o - h_{in}}{C_{php}} + T_{in}$$

$$P_o = R \rho_o T_{o-hp}$$

$$M = \frac{\phi}{\phi - \eta_\infty (\phi - 1)}$$

$$r_{hp} \left( \frac{2}{m} \right) - r_{hp} \left( \frac{m+1}{m} \right) = \frac{W_{ou-hp}^2}{A_{hp}^2 P_o} \left[ \frac{m-1}{2\eta_\infty m} \right]$$

$$P_{ou-hp} = r_{hp}$$

$$T_{ou-hp} = T_{o-hp} r^{\left( \eta_\infty \frac{y-1}{y} \right)}$$

$$\Delta h_I = C_{php} T_{o-hp} \left[ r_{hp}^{R/C_{php}} - 1 \right]$$

$$\eta = \frac{1 - r_{hp} \left( \eta_\infty \frac{\phi-1}{\phi} \right)}{1 - r_{hp} \left( \frac{\phi-1}{\phi} \right)}$$

$$P_{hp} = \eta \Delta h_I W_{ou-hp}$$

$$h_{ou-hp} = h_o + C_{php} (T_{ou-hp} - T_{o-hp})$$

$$\frac{d}{dt} (\rho_{ou-hp}) = \frac{1}{V_{hp}} (W_{in} - W_{ou-hp})$$

$$\frac{d}{dt} (W_{ou-hp}) = \frac{1}{\tau_s} (W_{in} - W_{ou-hp})$$

$$\frac{d}{dt} (x_o) = \frac{1}{V_{hp}} (W_{in} h_{in} - W_{ou-hp} h_o)$$

Where the outputs are:

$W_{ou-hp}$ ,  $P_{ou-hp}$ ,  $h_{ou-hp}$ ,  $P_{hp}$ ,  $T_{ou-hp}$

For further information we refer the readers to [MOKABERI, 2001] and [MEHRIZI, 2004]. The realized model for the above mentioned dynamic and static equations is depicted in Figure-4.

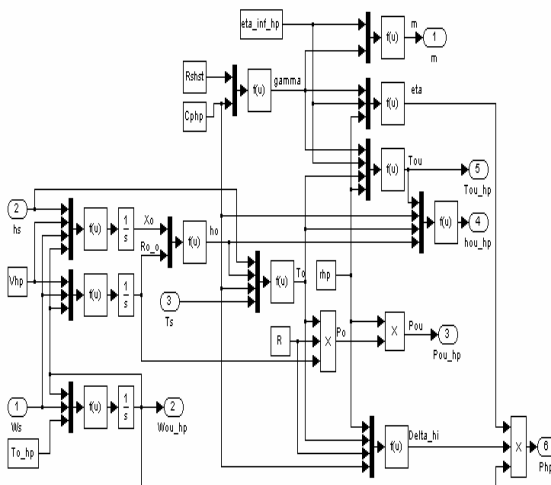
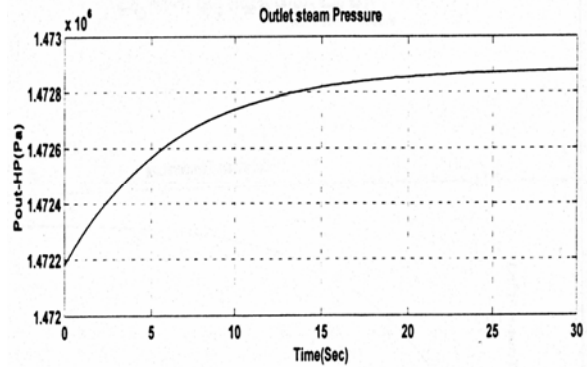
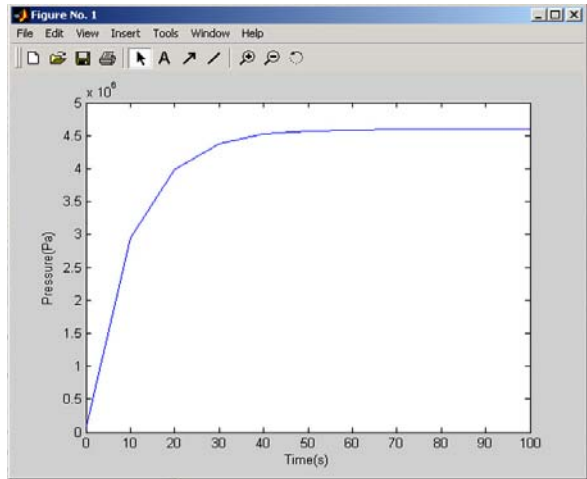

Figure-4 Realization of the HP-Turbine

By simulating the provided model with setting parameters as physical system, the following simulation results are given as shown in Figure-5(a and b) in two presentation formats. It is worth noting that a number of simulation results for different outputs are available in [MOKABERI, 2001] and [MEHRIZI, 2004].



(a)



(b)

Figure-5 Some Simulation Results for the HP-Turbine in two formats

### 3.5. Simulator Features

The designed simulator is equipped with different facilities.

- Instructor Control System: as a very useful facility, helps the instructors to better control progress of each individual instructor.

- Data Acquisition System: Similar to the main simulator, this system allows the instructor and trainees to gather all of the information and data which are needed for system analysis.

- Electric and Hydraulic Control System: This system along with other similar system allows the user to simulate different processes and control loops for training and research purposes.

- Automatic Process Control: This facility allows simulation of different processes and control simulation.

Other facilities are also available in the designed pc-based simulator. These facilities are shown in the following figures. Figure-6 shows the main page of the simulator. In the DAS part we can show plant schematics, different charts, trip review, alarm display and other options that exist in the main simulator.

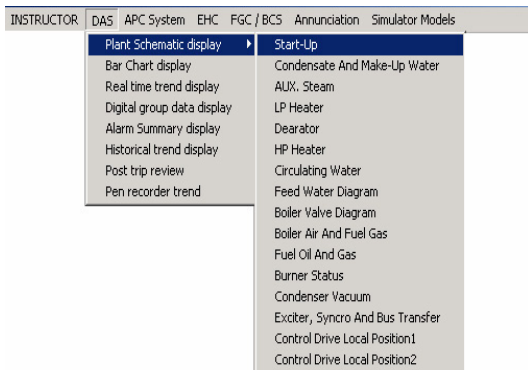

Figure-6 Main page of the simulator

Other facilities of the simulator like parameters change is shown in Figure-7.

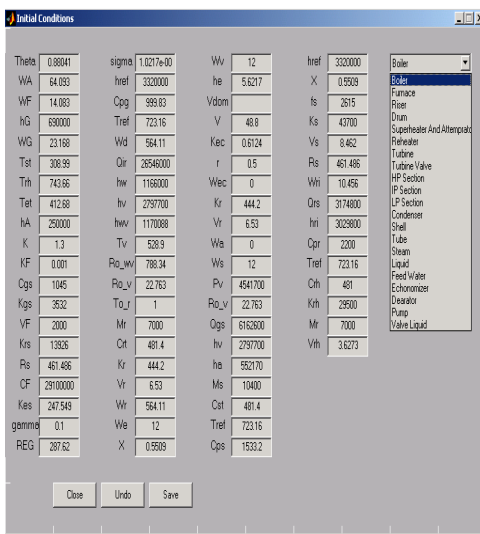

Figure-7 Parameters change facility in the simulator

#### 4. Conclusion

A pc-based simulator is introduced in this paper. The simulator has the same features as the TARASHT power plant simulator. The main simulator is manufactured by a network of VAX 4000-300 mini-computer, but the proposed simulator uses commercial Pentium IV PC. The simulator can be used for training and research work. Having modified the developed models, it would be possible to manufacture a special purpose simulator for each power plant in Iran great power network.

#### Acknowledgements

Author would like to express his sincere thanks to Power and Water University of Technology (PWUT) for the supports. Sincere appreciation also goes to managers of TARASHT power plant especially simulator section.

#### REFERENCES

ANSI Standard, Fossil Fuel Power Plants Simulators Requirements(1993). *ISA S77-20*.

Mitsubishi Heavy Industry Group, TARASHT Power Plant Simulator Technical Documents (2004), *TARASHT, Tehran, Iran*.

Mehrizi, M. F., (under supervision of A. Yazdizadeh, 2004)), Design and Implementation of a PC-Based Power Plant Simulator, *Master of Science Thesis, Power and Water University of Technology, Tehran, Iran*

Mokabberi H., (under supervision of A. Yazdizadeh, 2001)), Power Systems Modelling and Simulation. *Master of Science Thesis, Power and Water University of Technology, Tehran, Iran*.

Ordys A.W., A.W. Pike, M. A. Johnson, M. R. Katebi and M. J. Grimble(1994), In: Modeling and Simulation of Generation Power Plants. *Spring-Verlag, London Limited*.

Website of DEC and Intel Company, *www.digital.com and www.intel.com*, 2005

Yazdizadeh A., K. Khorasani (2001), Adaptive time delay neural network structure for nonlinear system identification. In: *Neurocomputing Journal, PD 1-19*

Yazdizadeh A., K. Khorasani, R.V. Patel (2000), Identification of a two-link flexible manipulator using adaptive time delay neural networks. In: *IEEE Transaction on System, Man. And Cybernetics, Part B 30(1)*.

Yazdizadeh A., K. Khorasani (1998), Identification of a turbo-generator using adaptive time delay neural networks. In: *The IEEE Conference on Control Applications, Trieste, Italy*.

Yazdizadeh A. (1990), Power Plant Training Simulators. In: *The first Conference on Electrical Engineering Training, 100-106, 1990, Shiraz, Iran*.