

## Improving iGS Ultrasonic Receiver Circuit of Low Cost Positioning Sensor for Ubiquitous Robotic Companion:

Jin, Jo Cheol\*, Lee, In Ock \*\*, Lim, Hyung Joon\*\*\*  
Shin, Joon Gyou\*\*\*\*, Lee, Won Bok\*\*\*\*\*, Lee, Chang Jin\*\*\*\*\*

\*Robot R&D Center, Ninety System Co., Ltd , Seoul, Korea(Tel: 02-2082-1261; e-mail: [jinjoch@ninety.co.kr](mailto:jinjoch@ninety.co.kr))

\*\*Ninety System Co., Ltd, Seoul, Korea(e-mail: [iolee@ninety.co.kr](mailto:iolee@ninety.co.kr))

\*\*\*Robot R&D Center, Ninety System Co., Ltd , Seoul, Korea(e-mail: [limhyjun@ninety.co.kr](mailto:limhyjun@ninety.co.kr))

\*\*\*\*Shin, Joon Gyou; Robot R&D Center, Ninety System Co., Ltd , Seoul, Korea(e-mail: [zit77@ninety.co.kr](mailto:zit77@ninety.co.kr))

\*\*\*\*\*Lee, Won Bok; Robot R&D Center, Ninety System Co., Ltd , Seoul, Korea(e-mail: [wblee@ninety.co.kr](mailto:wblee@ninety.co.kr))

\*\*\*\*\*Lee, Chang Jin; Robot R&D Center, Ninety System Co., Ltd , Seoul, Korea(e-mail: [royalgate@ninety.co.kr](mailto:royalgate@ninety.co.kr))

**Abstract:** The localization system, iGS has three kinds of medium to detect the distance of a mobile object. As the medium of distance detection, iGS uses ultrasonic wave, RF signal, and Infra-Red vision. iGS using ultrasonic signal has the target market for reasonable price. If the ultrasonic signal can be used with a lower performance digital signal processor(DSP), the price of the ultrasonic receiver will be more reasonable. For reasonable price, the ultrasonic receiver has the circuitry to change the fast signal into the slow signal. Even if the DSP has low speed, the slowly transformed signal can be sampled at a slow rate. The positioning accuracy of the slowly transformed signal is proven with the comparison test. If the ultrasonic receiver has the circuitry to transform the fast signal into the slow signal, iGS using ultrasonic signal can be a cost effective solution for the ubiquitous robot companion.

### 1. INTRODUCTION

The localization system, iGS using ultrasonic signal, has been developed by Ninety system co. and Pusan National University Intelligent Robot Lab. iGS is composed with one digital signal processor(DSP) board and several beacons. Beacons are posted at pre-determined position, and the DSP board is installed on a mobile robot. If you measure the distances from beacons to a robot, the position of the robot can be calculated by triangulation technique.

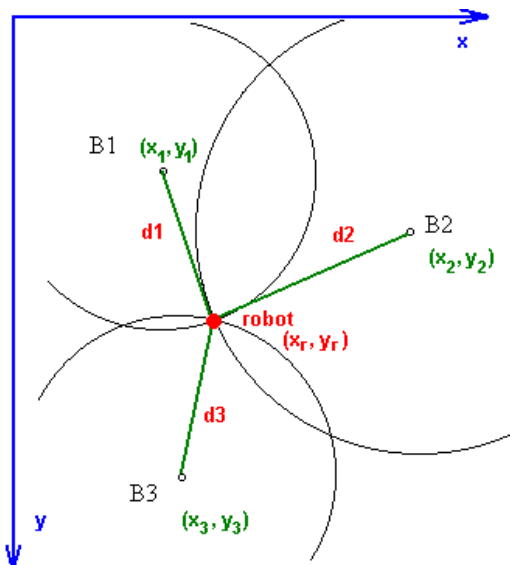

Fig. 1. Robot localization with 3 beacons

There are one robot and three beacons in Fig. 1. Beacons B1, B2 and B3 are located at  $(x_1, y_1)$ ,  $(x_2, y_2)$ , and  $(x_3, y_3)$  respectively. If the distances,  $d_1$ ,  $d_2$  and  $d_3$  are measured, the position of the robot  $(x_r, y_r)$  can be calculated with “(1)”.

$$\begin{bmatrix} (x_r - x_1)^2 + (y_r - y_1)^2 \\ (x_r - x_2)^2 + (y_r - y_2)^2 \\ (x_r - x_3)^2 + (y_r - y_3)^2 \end{bmatrix} = \begin{bmatrix} d_1^2 \\ d_2^2 \\ d_3^2 \end{bmatrix} \quad (1)$$

To measure the distance from a landmark called “Beacon”, you can measure the time of flight of ultrasonic waves.

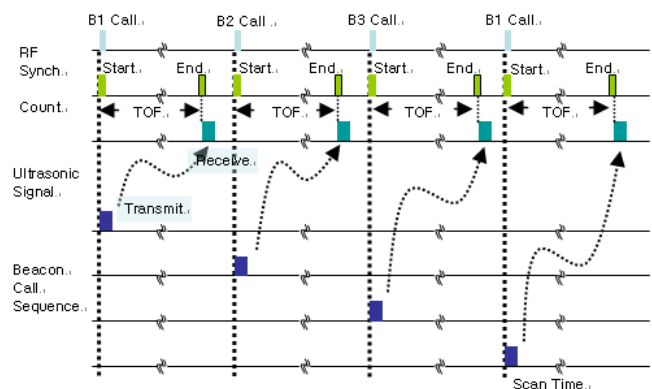

Fig. 2. RF synchronization and beacon calling sequence

To measure the time of flight(TOF), it is very important to detect the arrival time of ultrasonic waves.

The transmitter sends out RF signal and ultrasonic wave simultaneously. If the receiver gets the RF signal, the receiver starts counting the time till the ultrasonic wave arrives. Because the velocity of the RF signal is far faster than that of the ultrasonic wave, the count at the arrival of the ultrasonic wave can be considered as the time of flight. Beacon calling sequence is illustrated in Fig. 2.

iGS is intended to be applied to various applications. iGS is designed to be so flexible for platform transportation that iGS programming of DSP is C language based. The digital signal processor(DSP) of iGS samples the ultrasonic signal to detect the arrival time. To get accurate timing, the DSP chip should be busy to reduce the sampling interval. In this case, The DSP chip should have very high performance, and the cost of the chip should be relatively high.

In this paper, you see that the relatively slow sampling rate of ultrasonic signal can lead you to get the accurate arrival time, if you transform the ultrasonic signal. Therefore you can get the good time of flight with reasonable DSP price.

2. LOCALIZATION OF A MOBILE ROBOT

2.1 Measuring the distance from a landmark called "Beacon"

The velocity of the ultrasonic wave, v, is dependent on the air temperature, T. The relationship between the velocity and the air temperature is represented as "(2)".

$$v \approx 331.5 + 0.6 * T \tag{2}$$

where v is Velocity of ultrasonic wave [m/s],  
 and T is air Temperature [°C].

If it takes t seconds for the ultrasonic wave to travel from a beacon to a mobile robot, the distance, d, can be calculated as "(3)".

$$d = v * t [m] \tag{3}$$

d is the Distance from the ultrasonic transmitter to the receiver [m]., and t is the Time of ultrasonic flying from the transmitter to the receiver [sec].

2.2. Measuring the time of flight

The time of flight, t, of the ultrasonic wave can be measured as follows. As in Fig. 3, ultrasonic pulses are sent through a transmitter to a receiver. RF signal is also sent for the synchronization between the transmitter and the receiver.

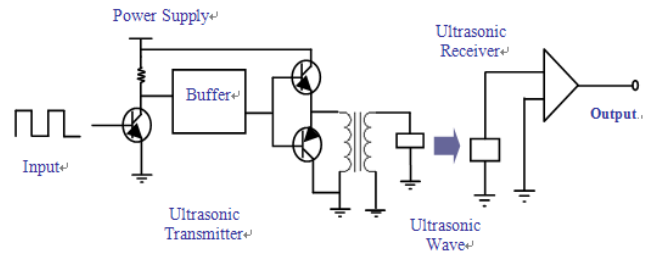

Fig. 3. The ultrasonic transmitter and the receiver

In Fig. 4, you can see the time difference between RF and ultrasonic wave arrival. If the transmitter send RF and ultrasonic wave at the time Tt, the receiver gets the RF signal almost at the same time, because the RF signal travels at the light velocity.

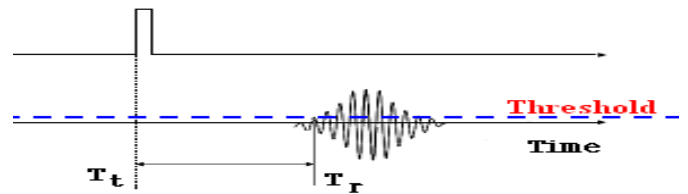

Fig. 4. The time difference between RF and ultrasonic arrival

If the receive gets the ultrasonic wave at the time Tr, the time of ultrasonic flight will be nearly the time difference between RF and ultrasonic wave arrival. The time difference t, can be expressed as "(4)".

$$t = Tr - Tt \tag{4}$$

3. DETECTING THE ARRIVAL TIME OF ULTRASONIC WAVE

You can see the scheme of ultrasonic wave detection in Fig. 5. After the ultrasonic signal is processed through bandpass filter and amplifier, it is A/D converted for the digital signal processor.

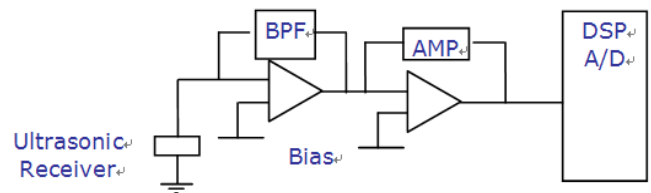

Fig. 5. The ultrasonic wave arrival detection

If the AD converted value is below the given threshold, the receiver ignores the signal, and waits more for the arrival of the ultrasonic wave. In Fig. 6, the sampled values at T1, T2, T3, and T4 will be ignored. At time Tr, the AD converted value exceeds the threshold, and the receiver thinks that the ultrasonic wave arrived at time Tr. If you use 25KHz ultrasonic wave, one cycle time Tc is 40µS.

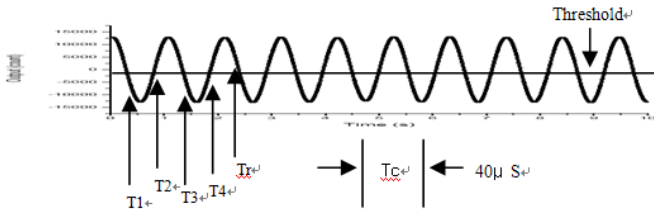

Fig. 6. The arrival time detection above the threshold

If you lose two cycles of the signal due to the sampling rate as in Fig. 6, the distance measurement will be different by “(5)”.

$$e = 2 * T_c * v \tag{5}$$

where e is due to sampled values below the threshold.

Let's assume that  $v = 340$  [m/s], and the distance error will be about 3cm.

To reduce this kind of error, the digital signal processor(DSP) should sample the ultrasonic signal very busily. The DSP chip should have very high performance. The DSP chip normally samples 3~4 μS for the negligible error of sampling time. This high performance requires that the cost of the chip be relatively high.

#### 4. IMPROVING iGS ULTRASONIC RECEIVER CIRCUIT

If you use the fullwave rectifier and the low pass filter as in Fig. 7, you can get the slow signal.

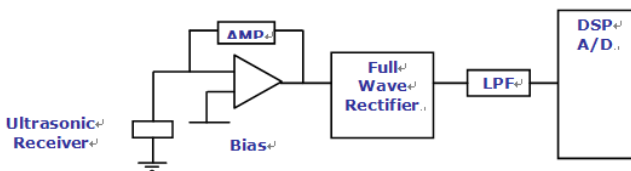

Fig. 7. The improved receiver circuit

The transformation process is as follows.

After the receiver gets the ultrasonic signal, the signal is amplified. Through the fullwave rectifier, the ultrasonic signal is transformed into the signal as in Fig. 8.



Fig. 8. The fullwave-rectified signal

This fullwave-rectified signal is processed with the lowpass filter. With these steps, the ultrasonic signal is transformed into slowly changing signal..

The slowly transformed signal is illustrated in Fig. 9.

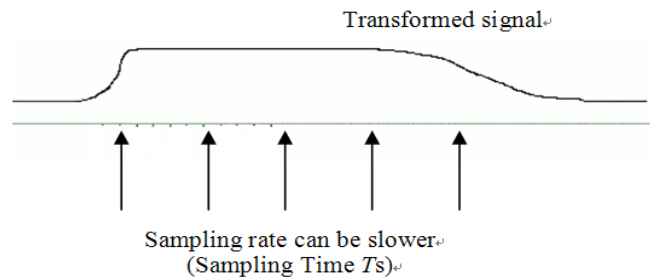

Fig. 9. The transformed signal with the improved receiver

In Fig. 9, the arrival time may differ only by one sampling time,  $T_s$ . The distance measurement will be different by “(6)”.

$$e = T_s * v \tag{6}$$

If  $T_s = 15$  [μS], and  $v = 340$  [m/s], the distance error will be about 5 [mm]. Therefore, even if you use a 15 μS DSP chip with the improved circuitry, instead of the high performance chip with 3~4 μS sampling rate, the position error will be negligible.

With the improved receiver circuit, the DSP chip has the choice to process the ultrasonic signal slowly, and good calculation of distance can be maintained.

Slow chips have more reasonable price than high performance chips. Cost effective design is essential to ubiquitous robots, and the improved receiver circuit of slowly transformed signal is helpful for ubiquitousness.

#### 5. EXPERIMENTS AND RESULTS

The ex-receiver samples the ultrasonic signal very fast, while the improved receiver samples the transformed signal relatively slow.

To compare the distance error of the improved receiver with that of the ex-receiver, the experiment procedure is as follows.

- 1) There stand four beacons arranged in the room, 3m x 3m x 2.7m.
- 2) Measure the position of nine locations.
- 3) Calculate the difference between the real location( $x_1, y_1$ ) and the measured location( $x_2, y_2$ ).
- 4) Check the maximum error of the localization.
- 5) According to the above procedure, proceed the experiments with an ex-receiver.
- 6) After the experiments with the ex-receiver, proceed the experiments with an improved receiver.

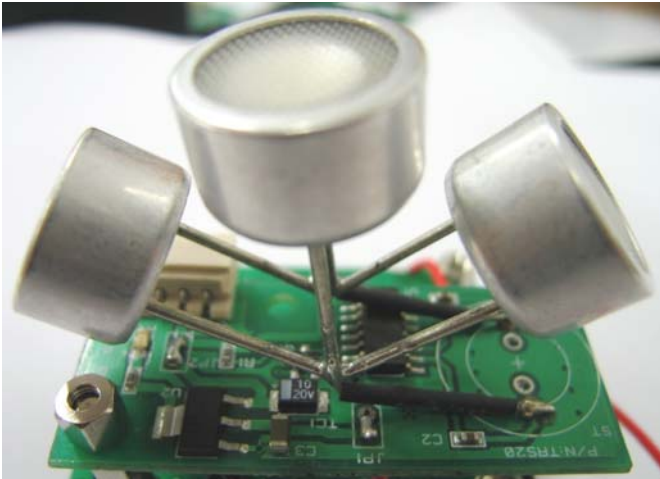

Fig. 10. The ultrasonic transmitter

The ultrasonic transmitter is illustrated in Fig. 10. For omnidirectional transmission of ultrasonic waves, three heads of the ultrasonic transmitter are used. Immediately after RF signal is sent for synchronization, the ultrasonic signal is sent to the receiver. RF signal is handled with the below board, which is illustrated in Fig. 11. RF signal is also used to address the beacon which should interact with the DSP.

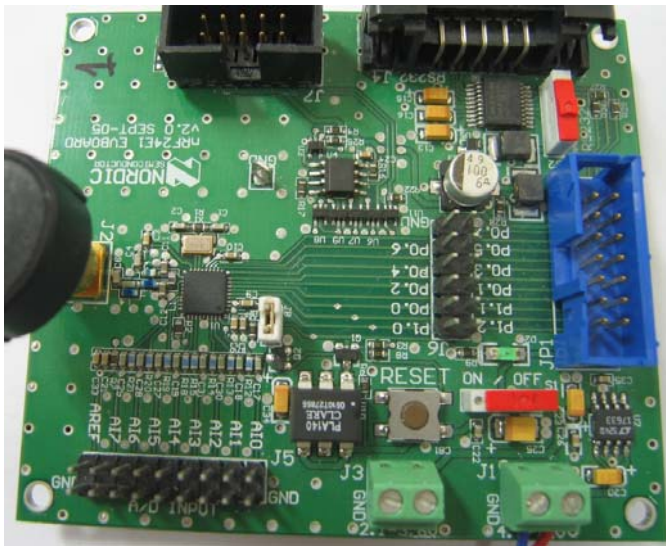

Fig.11. The RF signal board for synchronization

The ultrasonic signal from the transmitter is received to the receiver through the receiving board as in Fig. 12. Through the head of ultrasonic wave, the ultrasonic signal is transferred to the receiver circuitry. The receiver circuitry samples the incoming ultrasonic signal.

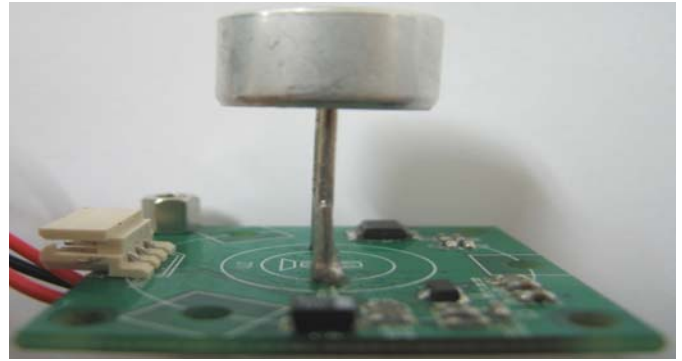

Fig.12. The ultrasonic receiving board

As illustrated in Fig. 13, the indicator signal toggles to notify when the sampling occurs in the receiver circuitry. It shows about 15  $\mu$ S sampling interval.

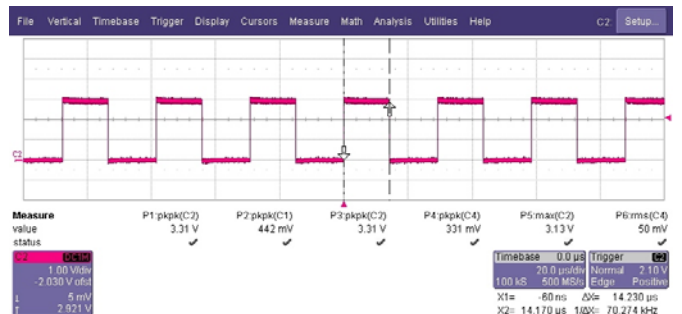

Fig. 13. The indicator signal toggling at sample time

The transformed signal of the ultrasonic wave is illustrated in Fig. 14. It shows the fullwave-rectified and low-pass-filtered signal. It includes the reflected signal at the tailing. This signal is sampled at 15  $\mu$ S sampling interval, and AD converted

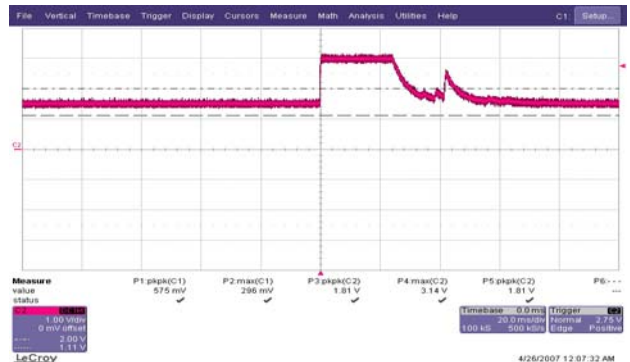

Fig. 14. The transformed signal of ultrasonic waves

In the room sized with 3 m x 3 m x 2.7 m, there are nine points pre-determined

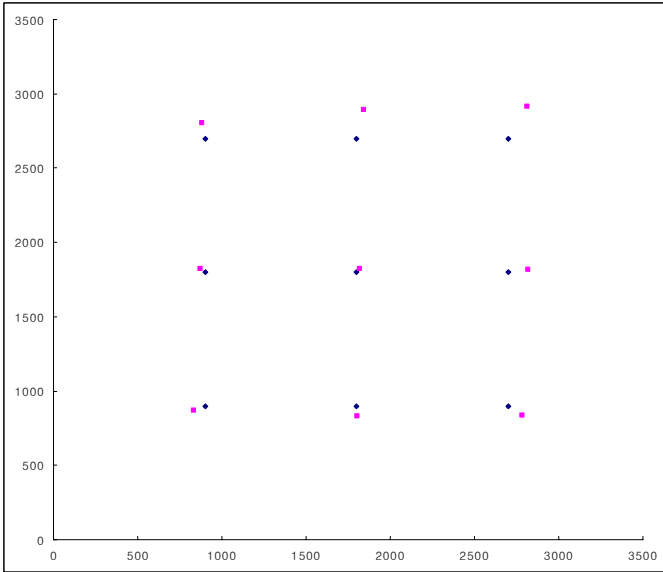

Fig.15. Big differences with an ex-receiver

In Fig. 15, the real position and the measured position are pointed as each point is compared with the other. There are big differences in some points with the ex-receiver.

With the ex-receiver, the errors of nine positions show to be 217 [mm] as a maximum, and 83[mm] as an average.

In Fig. 16, the reduced differences are illustrated with the improved receiver.

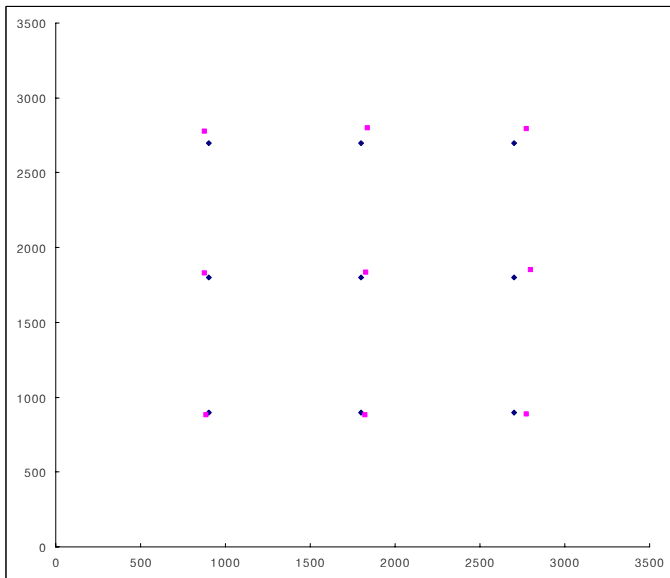

Fig.16. Reduced differences with an improved receiver

Due to the transformed signal, the differences between the real positions and the measured positions are reduced even if the sampling rate is relatively slow.

If you use the improved receiver, you will get the error results as follows. The maximum error is improved to 98[mm] from 217 [mm]. The average error is 47[mm].

## 6. CONCLUSIONS

Nowadays, we cannot work in the office without computers. As well, personal computers spread to our houses. We can see computing capabilities everywhere. Computing facilities of our societies are connected like a web with internet networks, etc. Ubiquitous computing and ubiquitous networking will lead to the ubiquitous revolution.

Now, major roles of robots are to work with simple and repetitive jobs in the factory. In the near future, paradigm of robots will shift to ubiquitous robotic companions. The companion will live in your life. He should be smart and kind. He should move by himself, and he should have his own intelligence to help you with enough kindness. For the smartness and kindness of ubiquitous robotic companions, there should be a prerequisite, so-called, the ubiquitous infrastructure.

If a robot intends to move by itself, at first it should know where it is. After localization of its position, it should know where to go. Autonomous moving means positioning and localization. The localization system is primarily included in the ubiquitous infrastructure.

The localization system is not only for ubiquitous robotic companions, but also for uCity, ubiquitous home, smart tag, ubiquitous life, etc. After all, the ubiquitous infrastructure raises localization issues.

Concerned with the localization system of the ubiquitous robot, there are many types of method to detect the distance, such as RF signal, ultrasonic signal, infrared vision, etc.

In Fig.17, the detection distance and the accuracy are illustrated depending on the measuring means.

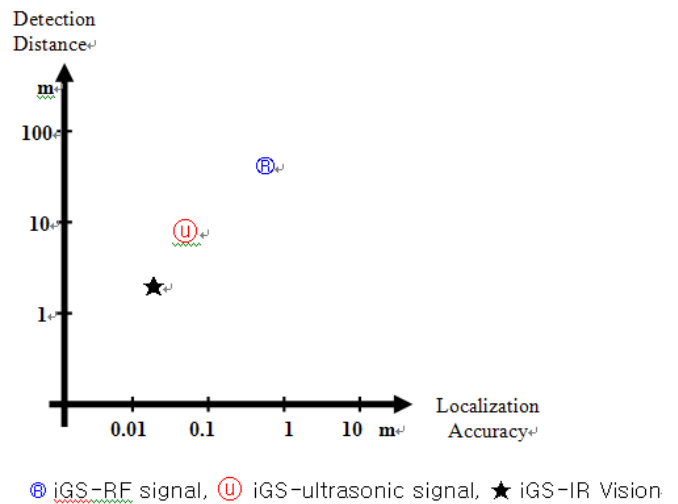

Fig.17. Localization distance and accuracy depending on the detection media

iGS using ultrasonic signal has the good accuracy and the good reach for the localization of ubiquitous robots.

Generally speaking, people do not want to pay much money to a little benefit. Only when people like to be served from robotic companions in real life, the robots will deserve their ubiquitousness. You are required to choose cost effective solutions with good performance for ubiquitous robots.

Ultrasonic sensors are relatively cheap, and easy to control with processors. The improved position sensor of iGS using ultrasonic waves, which transforms the fast signal into the slow signal, will provide robotic localization with reasonable price.

If you sample the ultrasonic signal slowly, it may result to the rough accuracy. But if you use the improved ultrasonic receiver and a little calibration, you can get the good accuracy as the experimental data shows.

If you choose improved iGS positioning sensors, you will find cost effective solutions with good performance for ubiquitous robotic companions.

## 7. ACKNOWLEDGEMENTS

"This work was partly supported by the IT R&D program of MIC/IITA[2005-S-111-02, intelligent robot sensor]".

## REFERENCES

- DaeGeun Seo and JangMyung Lee(2007). Localization Algorithm for a Mobile Robot using iGS. Pusan National University.
- SeungHo Cho and JangMyung Lee(2006). Localization System of a Mobile Robot using iGS. Pusan National University.
- JaeMu Yun and JangMyung Lee(2006). Robust Positioning of a Mobile Robot with Active Beacon Sensors. Pusan National University.
- Bum Jae You(2005). IT based Intelligent Service Robot 'URC'. Korea Institute of Science and Technology