

## Passive Correction of Position Error in Internet-Based Teleoperation<sup>\*</sup>

Alejandro Fernández Villaverde<sup>\*</sup> Antonio Barreiro Blas<sup>\*</sup>  
Cesáreo Raimúndez Álvarez<sup>\*</sup>

<sup>\*</sup> *Department of Automation & Control Engineering, University of  
Vigo, Spain (Tel: 0034-986-812222; e-mail:  
afernandez,abarreiro,cesareo@uvigo.es).*

---

**Abstract:** During the last two decades, important advances have been made in the field of bilateral teleoperation. Different techniques for performing stable teleoperation under difficult circumstances have been developed, specially in the passivity field. However, there is not one definitive method for correcting the position error, and no robust solutions for addressing this problem with variable delay communications (internet-based, for example) have been developed. In this paper an arrangement is proposed which is capable of achieving good position tracking while maintaining passivity. The resulting controller is suitable for unreliable, internet-like communications channels and its stability is independent of the plant.

---

### 1. INTRODUCTION

Teleoperated systems enable human operators to perform tasks on a remote plant. They follow a master-slave scheme, in which a slave manipulator (typically a robot) reproduces the movements of a master manipulator that is commanded by an operator. Specifically, we will refer here to bilateral teleoperation, where some force feedback is provided to the master side. As a result, the operator not only provides velocity commands, but is also part of the control loop. Thus, the human operator shares the control responsibility with the controllers that may be implemented. A great advantage of this setup arises when there is a contact between the slave and the environment. Force feedback can then provide the operator with a sense of telepresence, making him able to feel this contact and to modify his commands as a consequence.

Modern bilateral teleoperation stems from the classical result of Anderson and Spong (1989) and Niemeyer and Slotine (1991), who showed that, in presence of time delays, the communications channel can become unstable if master and slave exchange power variables (force and velocity). Consequently, they proposed to transmit a new pair of variables (*wave variables*) which can be obtained via the scattering transformation as follows. Let's consider a network element with a port where velocity ( $\dot{x}$ ) is taken as an input and force ( $F$ ) as an output. The total power flow through the port can be separated into two parts, one entering the system ( $u = \frac{1}{\sqrt{2b}}(F + b\dot{x})$ ) and one leaving it ( $v = \frac{1}{\sqrt{2b}}(F - b\dot{x})$ ), where  $b$  is a strictly positive parameter representing an impedance.  $u$  is then called *input wave*, as it increases the power flow into the system, and  $v$  is conversely the *output wave*. Essentially, each of these wave variable signals contains its own power, independent of its dual wave. This is not the case with the power variables ( $F, \dot{x}$ ), as both of them are required in order to

calculate a power flow. This is the reason why transmitting wave variables guarantees passivity of the communications channel for constant time delays, while transmitting power variables does not. Passivity, meaning that there is no generation of energy, is a useful concept as it guarantees (it is a sufficient condition) the stability of a system.

In recent years it has become common to use a digital, packet-switched network such as internet as the communications channel. This implies working in discrete time and having the information delivered in data packets with time-varying delays. Furthermore, it has been stated that the UDP protocol performs better than TCP/IP for teleoperation purposes, but its use causes data packets to arrive in disorder and eventually to be lost on the way. These complications can lead to a loss of passivity, unless an additional arrangement is made. A solution to maintain passivity of the channel under these circumstances was presented by Berestesky, Chopra and Spong (2004).

Position error in teleoperation may arise due to different reasons: for example, the master and slave devices may have an initial position mismatch. As only the master velocity, and not its position, is transmitted, there is no way to recover from this error. Additionally, if the slave has some contact (be it permanent or intermittent) with the environment, it can also cause a position displacement, which will result in position drift after some environmental contacts. The use of the scattering transformation itself contributes to a loss of tracking, specially for high delays: transmitting wave variables instead of power variables assures stability at the cost of decreasing position tracking performance. Yet another possible cause is the presence of numerical errors, originated from sampling and rounding operations or from data losses.

Several improvements have been proposed to overcome these problems. Niemeyer and Slotine (1997a) suggested transmitting the integrals of the wave variables (which encode position and momentum information). They also

<sup>\*</sup> This work was supported by the Spanish Ministry of Science and Technology (Research Project DPI2004-07670-C02-01).

proposed to modify the wave commands, see Niemeyer and Slotine (1997b). Yokokohji, Tsujioka and Yoshikawa (2002) presented a similar method, and introduced the idea of using the energy margin produced by this solution to reduce the position error that appears after a communication blackout. Chopra, Spong, Ortega and Barabanov (2004) presented a modified architecture in which additional position signals were transmitted and additional proportional controllers were added on each side. A condition for stability of these controllers was given, being valid only for constant time delays. As far as we know, there are no general methods capable of correcting position error in internet-based teleoperation while guaranteeing passivity. Some assumptions that are commonly made, such as considering constant time delays, or that the data arrives in the same order it is transmitted, limit the application of these techniques. On the other hand, it should be noted that the above mentioned arrangement proposed by Berestesky, Chopra and Spong (2004) not only passifies the communications channel when internet is used, but also allows for a better reconstruction of the signal and therefore improves position tracking. The two methods proposed here are built upon that arrangement.

The paper is organized as follows. In the next section we present a new method which is based on profiting from the energy margin that is being generated in the network when the solution proposed by Berestesky *et al.* is used. In section 3 we propose a modification of the wave variable correction method of Niemeyer and Slotine (1997b) that makes it more suitable for internet-like communications and for large delays. Then, both methods are integrated in a teleoperation scheme that maintains passivity of the overall system (see section 4). Additionally, some simulation results are shown, showing that the proposed control scheme provides good tracking performance in presence of unreliable communications. Finally, the conclusions are presented in section 5.

## 2. CORRECTION OF POSITION ERROR BASED ON THE ENERGY MARGIN

Firstly, we will recall the solution presented by Berestesky, Chopra and Spong (2004) for passively managing the communications with UDP-like protocols. Then, we will present a controller that uses the energy margin generated by this solution to correct the position error.

### 2.1 Passive management of UDP communication

The use of a packet-switched network as the communication channel, instead of traditional dedicated lines, is nowadays very widespread. This implies that the delay is no longer constant and therefore it is not straightforward to assume passivity. Furthermore, additional undesirable effects can appear depending on which protocol is selected to send the information. Munir and Book (2002) showed that the UDP protocol, although not confirmation based, is more suitable for control purposes than TCP/IP, as it preserves the shape of the sent wave with more accuracy. Its main disadvantage, however, is that it fails to guarantee the order of arrival of the data packets, which can also be lost on the way. These problems -variable time delay, disordered packets and data losses- can destabilize the system

if not properly treated. Therefore an arrangement capable of overcoming these pitfalls is needed. Berestesky, Chopra and Spong (2004) proposed a solution for managing the communications under these circumstances, guaranteeing passivity and improving tracking performance. The basic idea of this arrangement is as follows:

When a packet is lost due to unreliability of the network, it results in an empty sampling instance. Notice that the transmitted wave variables  $u(t), v(t)$  are such that  $u^2, v^2$  have units of power. Consequently, if  $h$  is the fixed sampling interval, then  $u^2h, v^2h$  represent energy packets. Hence, if in the event of an empty sampling instance, a "null packet strategy" is adopted (this is, considering that a new, zero-valued packet has arrived), there is no chance that any additional energy is injected into the system, and thus passivity is preserved. Also, even if there is no loss of packets, an empty sampling instance can appear due to increasing delay. In this case the same strategy must be adopted. The drawback of this choice, compared with its alternative (using the value of the previous packet for the new one), is that more energy is eliminated and consequently performance can be degraded.

In order to overcome this, the setup pictured at Fig. 1, where *Comm* stands for the communication channel, can be applied. The main idea is, basically, to send through the network, at every sampling instance, the sum of all the samples produced up to that time,  $\sum u_m$ , along with the time at which the information was sent,  $t$ . Sending the time means that, when a packet is received, it can be detected whether it is arriving in the correct order or not. Sending the sum of all samples instead of every sample alone allows for data recovery in case of loss of packets.

When a new packet arrives, the subtractor subtracts the values of the previous packet from it, obtaining the number of samples corresponding to the newly arrived data, and a quantity related to the energy contained in them. Then the interpolator distributes the new energy among the number of new samples, producing  $num$  samples of value  $\hat{u} = \frac{\sum u - (\sum u)_{previous}}{t - t_{previous}}$ . In this way, if a packet is lost, the interpolator will produce a "null packet" instance, but the data contained in the lost packet will be recovered as soon as the next one arrives. If a packet arrives in the wrong order, this is, after another one which was originally sent later, it is treated as a lost packet. Thus, no information is lost even if the communication is unreliable, although the shape of the originally sent signal is not perfectly recovered (this will be partially corrected in the next stage). The way the interpolator creates the new samples guarantees that the energy corresponding to them is not higher than that of the original samples, which preserves passivity.

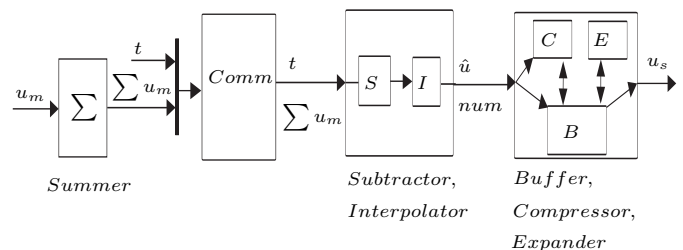

Fig. 1. Passivity-maintaining scheme for UDP

Finally, the samples are placed in a Receive Buffer before they are sent to the scattering transformation. This buffer provides samples at a constant rate and includes two additional elements, the Compressor and the Expander, that prevent it from overflowing or running empty, and allow for a better reconstruction of the signal.

This method guarantees passivity of the communications channel for arbitrary delays and losses: even in the case of infinite delays or 100% packet loss (communication blackout) the performance is degraded but stability is maintained.

## 2.2 A new energy margin controller

It must be noticed that the above mentioned arrangement is energy-dissipating: in order to assure passivity, the energy coming out of the interpolator is equal or less than the incoming energy. Thus, an *Energy Margin* (EM) is being generated and can be measured. The correction proposed here consists basically of reusing this energy margin, injecting it back to the system. This recovered energy is transformed into a correction of the wave variable that is proportional to the position error. The energy of the resulting term is carefully monitored so that it is not increased in a quantity larger than the available EM. In this way, the passivity of the system -and therefore its stability- is strictly guaranteed. A diagram of this correction is shown in Fig. 2, while the general configuration of the teleoperation setup, including this controller, is depicted in Fig. 6. The correcting algorithm is as follows:

- At each sampling instance, the measure of the energy of all the wave variables which have been previously sent through the network is also sent in the same data packet that the current wave variable. This value, which represents the total amount of energy injected into the network, is read ( $E$  in Figs. 2 and 6) at the other side of the network (slave side). As the energy is always increasing, any delay or data loss will lead to the assumption that the energy is less than the actually sent one. As the value of the originally sent energy is used to calculate the available energy margin, this is a conservative assumption and does not threat passivity.
- The value of the position command ( $x_m$  in Fig. 6) is also sent, in order to calculate the position error at the slave side ( $d$  in Figs. 2 and 6). A control term, proportional ( $K_{em}$ ) to the position error is calculated (provisional wave correction,  $u'_s$ ). This term will be added to the value of the wave variable  $u_{s3}$ , provided that the required energy is not larger than the originally sent energy (which means that there is still some energy margin available). In order to perform this calculation, the value of the wave variable  $u_{s3}$  is needed.
- In order to assure passivity of the communications channel, its outgoing energy must be equal or less than the incoming energy. Thus, the energy that the modified wave variable injects ( $E'$ ) is calculated. If it does not exceed the available energy margin  $EM$ , the wave variable correction is accepted (definitive wave correction,  $u_{s4}$ ), and the value of the energy margin is

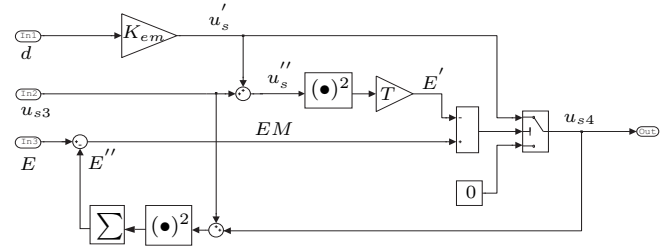

Fig. 2. Energy Margin correction

updated. If not, no modification of the wave variable is permitted.

This can be summed up in the following pseudo-code, representing the procedure since a wave variable is calculated at the master side:

At the Master Side:

$$Energy(t) = Energy(t - T_s) + Wave(t)^2 \cdot T_s$$

$$SendPacket(t, Energy, Wave, MasterPosition)$$

At the Slave Side:

$$ReadPacket$$

$$PositionError = MasterPosition - SlavePosition$$

$$ProvisionalCorrection = K_{em} \cdot PositionError$$

$$InstantEnergy = (Wave + ProvisionalCorrection)^2 \cdot T_s$$

$$IF (EnergyMargin \geq InstantEnergy) THEN$$

$$DefinitiveCorrection = ProvisionalCorrection$$

$$ELSE DefinitiveCorrection = 0$$

$$END IF$$

$$EnergyMargin =$$

$$= Energy - (Wave + DefinitiveCorrection)^2 \cdot T_s$$

The performance of this controller is shown in section 4.

## 3. CORRECTION OF POSITION ERROR BASED ON TRIMMED WAVES

We will refer to the standard teleoperation scheme depicted in Fig. 3. This architecture is focused on passivity: force and velocity are exchanged, except through the communications channel, where wave variables are used instead. We will first review a correction to this architecture presented by Niemeyer and Slotine (1997b), and then we will propose a modification of it.

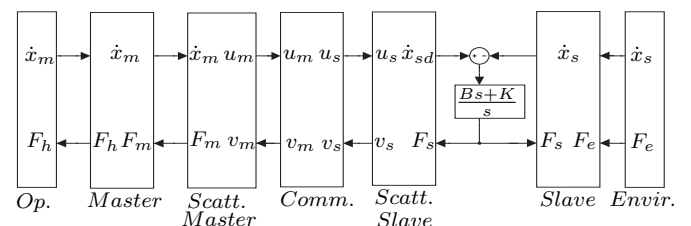

Fig. 3. Standard teleoperation scheme

### 3.1 The original correction

Niemeyer and Slotine (1997b) proposed the arrangement depicted in Fig. 4. The main idea is to add a corrective term ( $u_{m2}$  in the diagram) to the wave command in response to any mismatch between  $x_m$  and  $x_{sd}$ . In order to maintain passivity, this correction can not introduce any power into the system. As wave variables represent the square root of power, this condition is satisfied if the magnitude of the corrected wave command is bounded by the original uncorrected version. What the correction is doing is in fact “trimming” the wave variables, this is, taking power off them. This places an important limitation on the control action, as generally only small corrections will be allowed.

### 3.2 Our modification

We propose to use a similar idea, but with two differences:

- The correction is placed at the slave side, instead of the master side. This means that, once it is calculated, it is immediately applied, instead of being transmitted through the communications channel. This seems to be the logical option, specially in presence of large delays. In the next section it is shown that it provides better performance under these circumstances.
- A more general correction can be carried out if the position error is considered as  $x_m - x_s$  instead of  $x_m - x_{sd}$ , with  $x_s$  being the position of the slave and  $x_{sd}$  the integrated velocity resulting for the slave scattering transformation. In fact, errors are very similar and only small differences can be noticed, but there is a slight improvement in performance for large delays.

This method (see fig. 5) can be adapted for internet-like communications, once we have used the signal reconstruction technique reviewed in section 2.1. Besides, as the idea of this method is to “take power off the system”, it creates an additional energy margin that can be used for the Energy Margin controller. In the next section both controllers are combined and simulation results are presented.

## 4. OVERALL SETUP AND EXPERIMENTS

The two controllers can be integrated in a teleoperation setup as in Fig. 6, where S-I-B-C-E stands for Subtractor-Interpolator-Buffer-Compressor-Expander. The wave variable obtained after the network transmission ( $u_{s1}$ ) is modified according to the “Trimmed Wave controller” (TW) described in the previous section. Then the energy margin generated at the network (and also at the TW) is used in the “Energy Margin controller” (EM) to add another corrective term ( $u_{s4}$ ) and obtain the finally applied wave variable ( $u_s$ ). This is transformed into a velocity command  $\dot{x}_{sd}$ , and a PI control action (or other) is produced:  $F_s = (B + \frac{K}{s})(\dot{x}_{sd} - \dot{x}_s)$ .

In order to test the performance of the proposed scheme, several simulations were carried out in a Matlab/Simulink environment. Communications via UDP were simulated with the Handshake ProSense Virtual Touch Toolbox (Network Option). This allowed us to specify different conditions for the network, and two possible scenarios were considered: a “small delay” one, representing normal

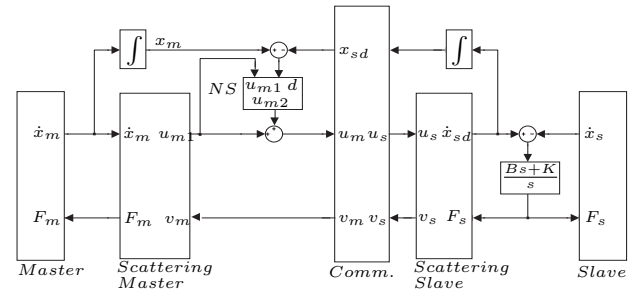

Fig. 4. Overview of the Niemeyer & Slotine arrangement

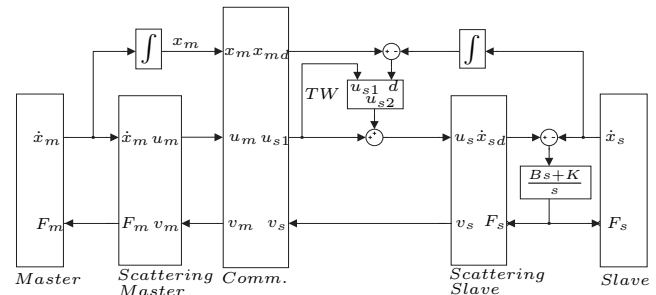

Fig. 5. Wave “trimmer” on the slave side

communications via internet/UDP, and a “large delay” case with more extreme conditions, that was used to test possible applications in fields with very high delays such as, for example, space teleoperation. In the “small delay” case, an average delay of 0.2 seconds, with a standard deviation of 0.07 and a 5% packet loss was forced for each channel (master to slave and slave to master). In the “large delay” case these values were 3, 0.2 and 10%, respectively. A typical second order plant with transfer function  $\frac{1}{M \cdot s^2 + B \cdot s}$  was used at the master and slave sides. The master exerted a sinusoidal force, and an initial offset between master and slave devices was forced. The desired position is plotted as it arrives at the slave side (not as it is originally sent), thus having a warped look -instead of a purely sinusoidal wave shape- due to the variable time delays.

First of all we will analyze the difference between the two controllers described in Section 3: the original arrangement by Niemeyer and Slotine (which we will refer to as NS) and our modification (TW). Recall that the differences of TW with respect to NS are that TW is placed at the slave side of the teleoperation setup and uses the position of the slave device ( $x_s$ , see Fig. 5) in the position error calculations, while NS is placed at the master side and uses another value for the position ( $x_{sd}$ , see Fig. 4).

In figs. 7 and 8 the influence of the master or slave location is reflected for small and large delays, respectively. In order to reflect this difference more accurately the slave side controller used  $x_{sd}$  instead of  $x_s$  as the position measure. While no significant differences are noticed for small delays, in the large delay case it can be clearly noticed that the slave location performs substantially better than the master one.

The difference between the choice of  $x_s$  or  $x_{sd}$  for the calculation of the position error when using TW is shown

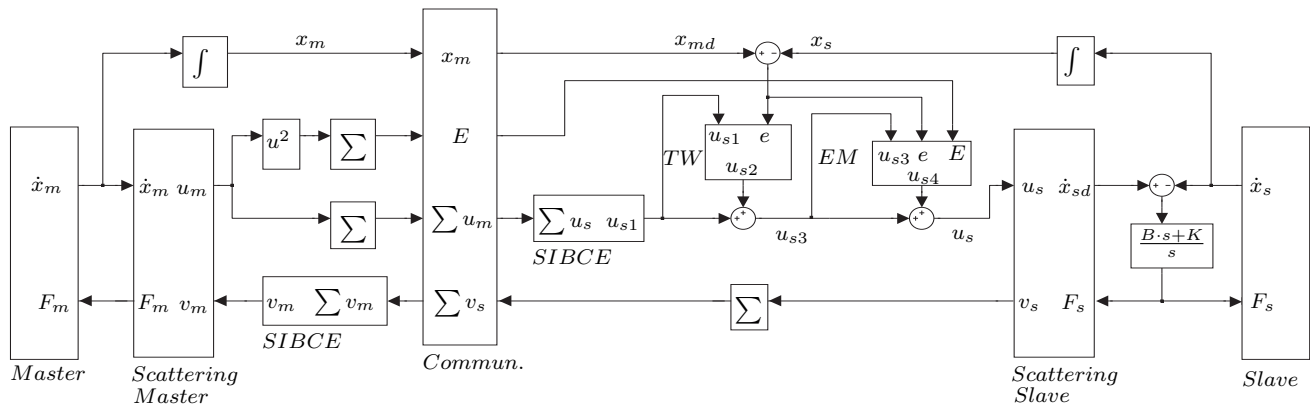

Fig. 6. Overall setup

in figs. 9 and 10. Again, for small delays there are no important differences, but for large delays the choice of  $x_s$  achieves 90% of the desired amplitude instead of the 80% of the  $x_{sd}$  choice.

Therefore, the choice of the TW setup is shown to be more suitable for large, varying delays than the NS on which it is based.

Next we will evaluate the energy margin controller (EM). As its action depends on the available energy margin, and this increases with the delay and its variations, this type of controller is more effective for large delays and this is the scenario we will consider. Of course, this does not mean that it is desirable to have large delays, as they always decrease the performance of the system. But, the more important the delays, the more important will be the action that the EM controller is allowed to exert in order to correct the position error. Therefore, we will consider the “large delay” case. The energy margin generated in the network (which is the only element capable of generating and energy margin, as we are not using the TW in this simulation) under these circumstances is shown in Fig. 11.

The EM calculates a wave variable correction which is proportional to the position error (see Fig. 12). This correction, however, can only be applied if the passivity of the communications channel is not violated. With this restriction, the resulting wave correction is the one shown in Fig. 13. The performance of the EM is shown in Fig. 14, where it can be noticed that the EM corrects the position error more effectively than the TW (see Fig. 10) under these circumstances. However, it is possible to combine both controllers (see Fig. 6), which, as shown in Fig. 15,

allows for a faster correction of the initial offset and improves the accuracy of the position tracking. The performance of the standard teleoperation setup -without correction of the position error- is also plotted in this figure, showing that the system does not recover from the initial offset and the movement of the slave does not achieve the desired amplitude.

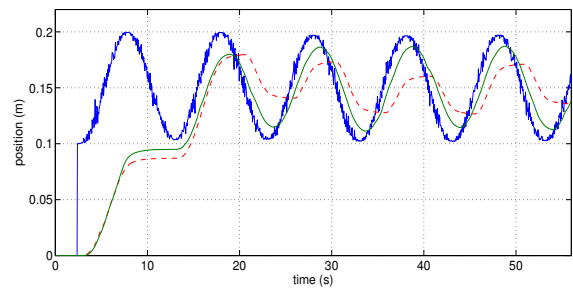

Fig. 8. Master (dashed) vs. Slave (solid) for large delays

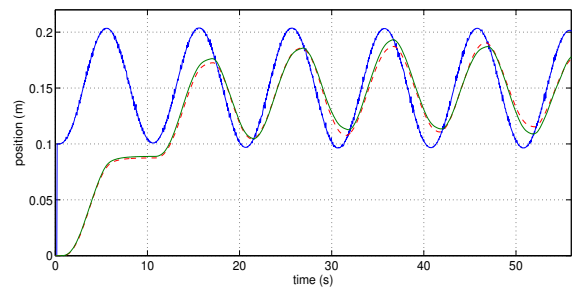

Fig. 9.  $x_{sd}$  (dashed) vs.  $x_s$  (solid) for small delays

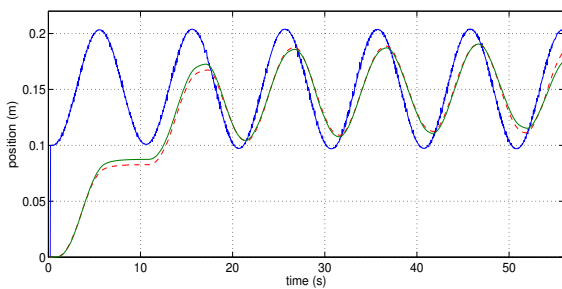

Fig. 7. Master (dashed) vs. Slave (solid) for small delays

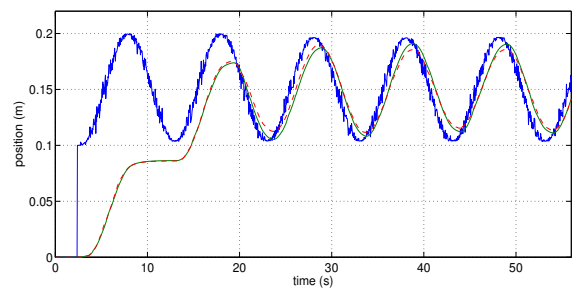

Fig. 10.  $x_{sd}$  (dashed) vs.  $x_s$  (solid) for large delays

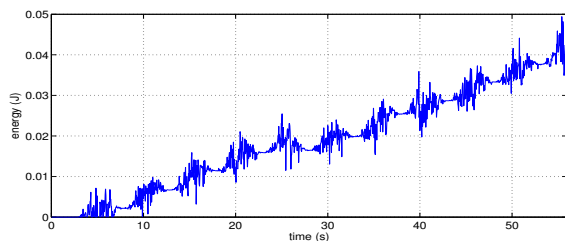

Fig. 11. Energy Margin generated in the communications channel

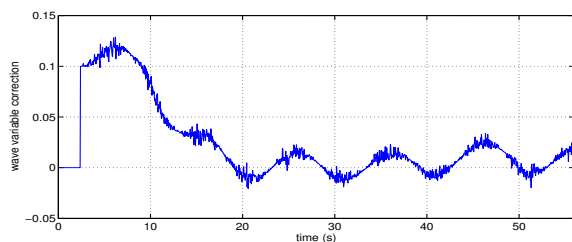

Fig. 12. Ideal wave variable correction

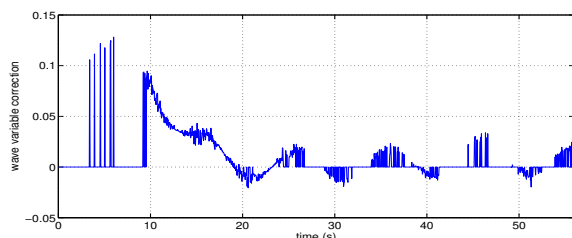

Fig. 13. Effective wave variable correction

It must be pointed out that very demanding conditions were chosen for these simulations. Currently, some experiments with real plants and under real conditions are being carried out. Fernández, Barreiro and Raimúndez (2008) applied the proposed correction to a teleoperated gantry crane, reporting good results.

## 5. CONCLUSIONS

In this paper we have presented two methods for improving position tracking in internet-based teleoperation in a passivity-conserving way. The first method is based on a previous one presented by Niemeyer and Slotine (1997b) and adds some modifications which improve tracking for large time delays. The second method stems from the idea of profiting from the energy margin generated when passifying the communications channel. Its main advantage is its validity for internet-based teleoperation and, generally speaking, time-varying delays. As the available energy margin increases with the unreliability of the network, the method is specially suitable for communications with large, unpredictably varying delays and loss of data. It is shown that both methods can be combined to improve the tracking performance.

## ACKNOWLEDGEMENTS

Supported by the Spanish Ministry of Science and Technology (Research Project DPI2004-07670-C02-01).

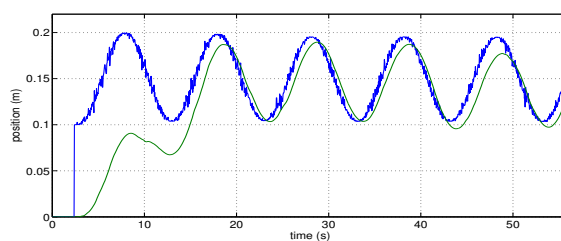

Fig. 14. Position Tracking with the EM controller

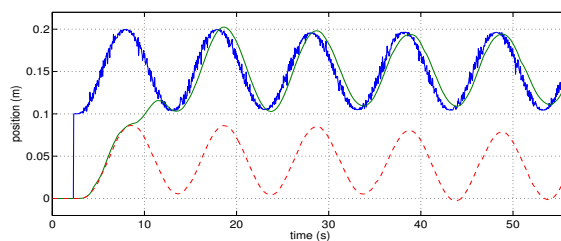

Fig. 15. EM + TW (solid) vs. standard setup (dashed)

## REFERENCES

- R. Anderson and M.W. Spong. Bilateral control of teleoperators with time delay. *IEEE Trans. on Automatic Control*, vol. 34, no. 5:494-501, 1989.
- P. Berestesky, N. Chopra and M.W. Spong. Discrete time passivity in bilateral teleoperation over the internet. *Proceedings of the 2004 IEEE Int. Conf. on Robotics and Automation*, vol. 5, 4557-4564.
- N. Chopra, M.W. Spong, R. Ortega and N. Barabanov. On position tracking in bilateral teleoperation. *Proceedings of the 2004 American Control Conf.*, vol. 6, 5244-5249.
- A. Fernández, M.R. Díaz-Cacho, A. Barreiro and C. Raimúndez. Haptic interface for crane teleoperation. (*unpublished*), 2008.
- S. Munir and W.J. Book. Internet-Based Teleoperation Using Wave Variables With Prediction. *IEEE/ASME Transactions in Mechatronics*, vol. 7, no. 2:124-133, 2002.
- G. Niemeyer and J.J. Slotine. Stable Adaptive Teleoperation. *IEEE Journal of Oceanic Engineering*, vol. 16, no. 1:1619-1625, 1991.
- G. Niemeyer and J.J. Slotine. Using wave variables for system analysis and robot control. *Proceedings of the 1997 IEEE Int. Conf. on Robotics and Automation*, vol. 2, 1619-1625.
- G. Niemeyer and J.J. Slotine. Designing force reflecting teleoperators with large time delays to appear as virtual tools. *Proceedings of the 1997 IEEE Int. Conf. on Robotics and Automation*, vol. 3, 2212-2218.
- Y. Yokokohji, T. Tsujioka and T. Yoshikawa. Bilateral control with time-varying delay including communication blackout. *Proceedings of the 10th Symp. on Haptic Interfaces for Virtual Envir. & Teleoperator Sys.*, 285-292.