

STEERING STABILITY BASED ON FUZZY-LOGIC

Beatriz L. Boada, María Jesús L. Boada,
Belén Muñoz and Vicente Díaz

*Mechanical Engineering Department. Carlos III University.
Avd. de la Universidad, 30. 28911.
Leganés-Madrid-SPAIN.*

Abstract: This paper presents a controller based on fuzzy-logic to ensure simultaneously vehicle handling and stability. The developed controller generates the suitable yaw moment which is obtained from the difference of the brake forces between the front wheels so that the vehicle follows the target values of the yaw rate and the side slip angle. The simulations results show the effectiveness of the proposed control method when the vehicle is subjected to different cornering steering maneuvers such as change line and J-turn. *Copyright*© 2005 IFAC.

Keywords: Fuzzy Logic, Yaw Moment Control, Vehicle Dynamics

1. INTRODUCTION

In the last years, one of the main challenges in vehicle design is to improve the vehicle handling and stability. Recently, the yaw moment control has proved its effectiveness to improve the vehicle handling and stability.

The transverse distribution of the vehicle driving or braking forces between the wheels is the most common approach to generate the required yaw moment. Several authors have proposed different methods to achieve the specified control performance. In (Park and Ahn, 1999) a design method based upon an H_∞ optimal yaw-moment control for controlling brake torque is proposed. (Furukawa and Abe, 1998) introduce the algorithm DYC with estimated side-slip angle using on-board-tyre-model. (Shino *et al.*, 2000) propose a control system based on optimal control theories to improve the handling and stability of electric vehicles by direct yaw moment generated from the driving or braking forces. In (Esmailzadeh *et al.*, 2003) a new optimal control law for direct yaw

moment control, to improve the vehicle handling, is developed.

In this paper, we propose a fuzzy logic controller based on the control of the yaw moment. The advantages of fuzzy methods are their simplicity and the controller is described in vague linguistic terms that suits the subjective nature of vehicle stability and handling. On the other hand, the fuzzy logic control allows to control non-linear systems with a good performance. The main advantages of using non-linear design methodologies are that they are more likely to achieve the desired vehicle behavior because they are based on more realistic models.

2. THE VEHICLE MODEL

The eight-degree-of-freedom (8DOF) vehicle model is the model used in this research and includes both the lateral and longitudinal dynamics as well as the nonlinearities in the system (Smith and Starkey, 1995; Ray, 1997; Esmailzadeh *et*

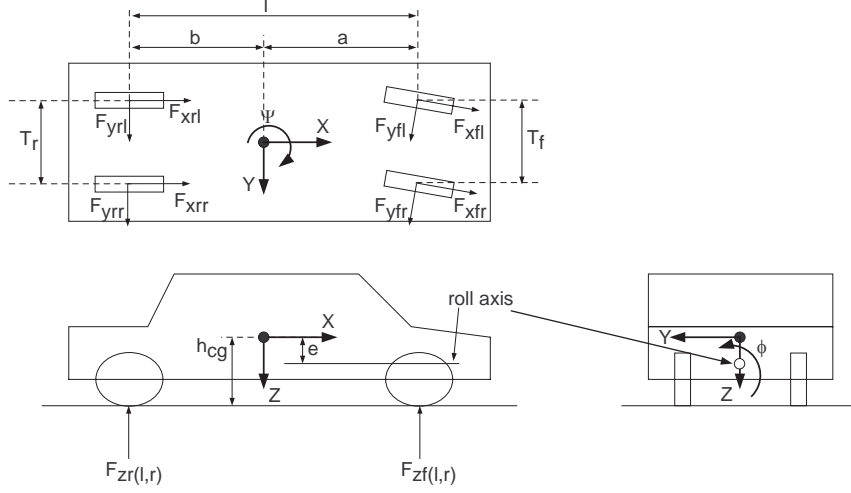

Fig. 1. Parameter definitions for the eight-degree-of-freedom vehicle model

al., 2001). The equations of motion for the 8DOF (Degree Of Freedom) model are derived from figure 1:

$$m\dot{U} = mVr + F_{xfl} + F_{xfr} + F_{xrl} + F_{xrr} \quad (1)$$

$$m\dot{V} = -mUr - m_s e \dot{p} + F_{yfl} + F_{yfr} + F_{yrl} + F_{yrr} \quad (2)$$

$$I_x \dot{r} = I_{xxs} \dot{p} + a(F_{yfl} + F_{yfr}) - b(F_{yrl} + F_{yrr}) + \frac{T_f}{2}(F_{xfl} - F_{xfr}) + \frac{T_r}{2}(F_{xrl} - F_{xrr}) \quad (3)$$

$$I_{xzs} \dot{p} = -m_s e \dot{V} + I_{xzs} \dot{r} - m_s e Ur + m_s g e \sin \phi - K_\phi \phi - C_\phi \dot{\phi} \quad (4)$$

$$\dot{\phi} = p \quad (5)$$

$$I_w \dot{\omega}_i = -R_w F_{xi} + T_i \quad \text{for } i = fl, fr, rl, rr \quad (6)$$

where T_i is the difference between the driving torque (T_d) and the brake torque (T_b) applied to i -wheel: $T_i = T_d i - T_b i$

The terms F_{xi} and F_{yi} are the respective tyre forces in the X and Y direction, which can be related to the tractive and the lateral tyre forces:

$$F_{xi} = F_{ti} \cos \delta_i - F_{si} \sin \delta_i \quad \text{with } i = fl, fr, rl, rr \quad (7)$$

$$F_{yi} = F_{ti} \sin \delta_i + F_{si} \cos \delta_i \quad \text{with } i = fl, fr, rl, rr \quad (8)$$

where δ_i is the steering angle including roll steer:

$$\delta_{fl} = \delta_{fr} = \delta + K_{rf} \phi \quad (9)$$

$$\delta_{rl} = \delta_{rr} = K_{rr} \phi \quad (10)$$

The Dugoff model (Dugoff *et al.*, 1970) is introduced to simulate the lateral and longitudinal forces generated by tyres.

3. CONTROLLER DESIGN

In order to improve the handling and stability of the vehicle, the yaw rate (the yaw velocity of

the chassis) and the side slip angle (the angle between the directions of the vehicle's velocity and the vehicle's chassis) of the vehicle are controlled to follow their target values. The yaw rate can be measurable by a gyroscope but the side slip angle can not be measurable directly and has to be estimated by an observer. The two-degree-of-freedom (2DOF) vehicle model with constant speed is adopted to estimate the side slip angle.

The control system proposed in this study it is shown in figure 2. The block labelled "reference model" generates the reference of the yaw rate and the side slip angle to the steering input. The desired yaw rate has been computed by eq. 11 as a function of the drivers steering wheel angle input and the vehicle speed by considering a constant forward speed (Horiuchi *et al.*, 1999) (Esmailzadeh *et al.*, 2003):

$$r_d = \frac{U}{l(1 + AU^2)} \delta \quad (11)$$

where A is the stability factor. The desired side slip angle of vehicle is equal to zero:

$$\beta_d = 0 \quad (12)$$

Both reference values are considered to improve the handling and stability of the vehicle.

4. FUZZY-LOGIC CONTROLLER

The control system proposed in this article uses a fuzzy logic controller. Fuzzy control is a non-linear control method and it can be used to deal with complicated non-linear dynamic control problems. The use of fuzzy logic enables the heuristic rule-based techniques commonly applied to discretely variable to be extended for use in the continuously variable situation, without significantly increasing the size of the rule-based. The fuzzy

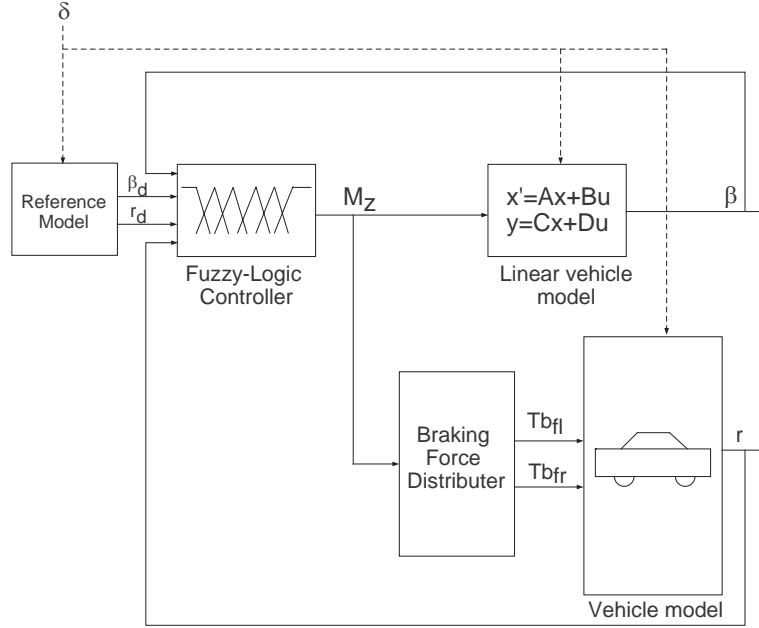

Fig. 2. Block diagram of the proposed control system

control has been applied with success in many fields like decision support, system identification, control, etc. In this last context, the number of applications of fuzzy logic to vehicle control has increased significantly over the last years with good results (Yoshimura and Emoto, 2003; Hajjaji *et al.*, 2004; Boada *et al.*, 2005).

The input variables in fuzzy controller are the vehicle side slip angle β and the difference between the yaw rate reference and the yaw rate $r - r_d$, and the output variable is the yaw moment M_z . The yaw moment is generated from the difference of the brake force between the left and right front wheels.

The architecture of fuzzy logic controller consists of four steps:

- (1) **Fuzzification:** it makes the measured controller inputs dimensionally compatible with the condition of the knowledge-based rules using suitable linguistic variables. In table 1 the linguistic terms are shown.
- (2) **Fuzzy decision process:** it processes a list of rules from the knowledge base using fuzzy input from the previous step to produce the fuzzy output. The fuzzy controller uses the Mamdani fuzzy inference system.
- (3) **Defuzzification:** it scales and maps the fuzzy output from fuzzy decision process to produce an output value which is the input to the system being controlled, in our case, the yaw moment. The defuzzification method used in this project is the *center of area*.
- (4) **Output scaling:** The controller output \hat{M}_z is scaling to map the yaw moment M_z from the normalized interval:

$$M_z = 10000 \cdot \hat{M}_z \quad (13)$$

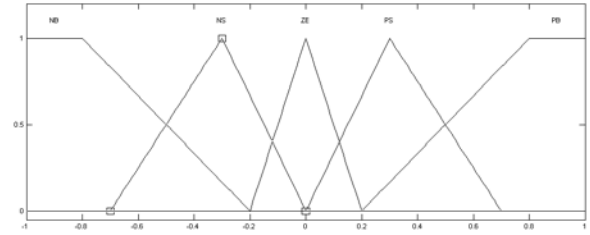

Fig. 3. Membership function for β

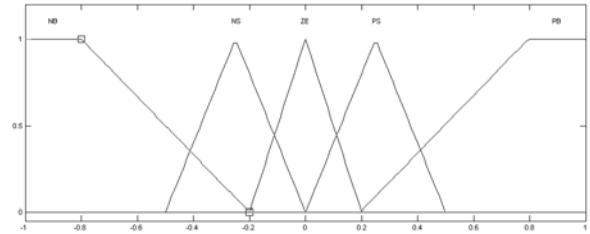

Fig. 4. Membership function for $r - r_d$

Table 1. Linguistic terms

NB	Negative Big
NM	Negative Medium
NS	Negative Small
ZE	Zero
PS	Positive Small
PM	Positive Medium
PB	Positive Big

Table 2 shows rules for the proposed fuzzy logic controller. These rules are introduced based on the expert knowledge about the system and the extensive simulations performed in this study. Figures 3, 4 and 5 show the membership functions and ranges of values of β , $r - r_d$, and \hat{M}_z respectively.

Table 2. Rule base

β	$r - r_d$	\hat{M}_z	weight	β	$r - r_d$	\hat{M}_z	weight
NB	PB	NB	1	NB	NB	PB	1
NS	PB	NB	1	NS	NB	PB	1
ZE	PB	NM	1	ZE	NB	PM	1
PS	PB	NB	1	PS	NB	PB	1
PB	PB	NB	1	PB	NB	PB	1
NB	PS	NB	1	NB	NS	PB	1
NS	PS	NM	1	NS	NS	PM	0.5
ZE	PS	NS	1	ZE	NS	PS	0.5
PS	PS	NM	1	PS	NS	PM	0.5
PB	PS	NS	1	PB	NS	PS	1
NB	ZE	NS	1				
NS	ZE	NS	1				
ZE	ZE	ZE	1				
PS	ZE	PS	1				
PB	ZE	PS	1				

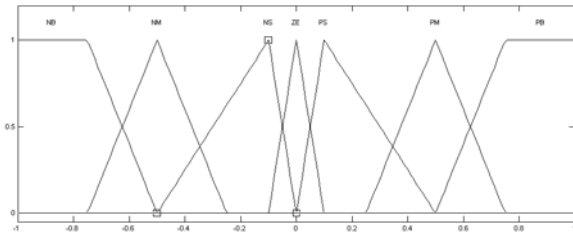
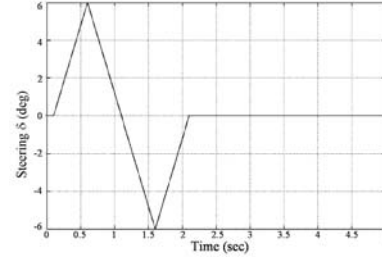

Fig. 5. Membership function for \hat{M}_z

5. SIMULATIONS RESULTS

Simulation results are carry out using an eight-degree-freedom vehicle model and a simulation software based on MATLAB and SIMULINK. The parameters characterizing the vehicle model are shown in table 3. These parameters correspond to a typical vehicle model. The fuzzy logic controller was designed using MATLAB's Fuzzy Logic Toolbox. To clarify the effects of the proposed controller, both the vehicle dynamics with and without controller are shown.

The effectiveness of our controller is shown considering two different steering angle inputs (see figure 6). Figures 7 and 8 show the simulation results for a change line maneuver at a velocity of 20 m/s and a velocity of 30 m/s with a nominal friction coefficient of 0.9, value deemed to be generally representative of dry pavement. Figures 7(a) and 8(a) give the time response of sideslip angle for a controlled and uncontrolled vehicle model at a velocity of 20 m/s and a velocity of 30 m/s respectively. Figures 7(b) and 8(b) give the time response of yaw rate for a controlled and uncontrolled vehicle model at a velocity of 20 m/s and a velocity of 30 m/s respectively. To track the references, the controller generates a yaw moment M_z . In the above figures we can observe that the yaw rate and the sideslip angle of the controlled system almost exactly track to the reference values compared with the response of no control. In figures 9(a) and 9(b) the paths followed by the



(a) Change line maneuver

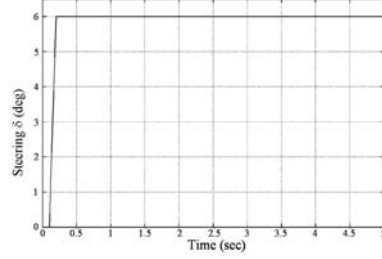

(b) J-turn maneuver

Fig. 6. Steering input

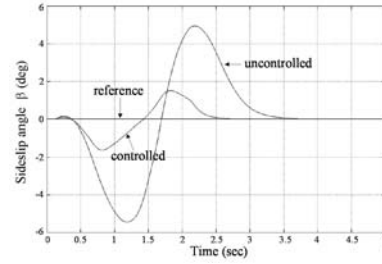

(a) Comparison between β value with and without controller, and β reference value

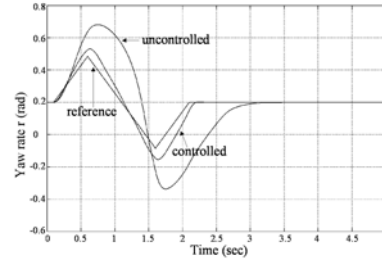

(b) Comparison between r value with and without controller, and r reference value

Fig. 7. Simulation results for a change line maneuver with a initial speed of 20 m/s on a dry surface

vehicle with and without controller are shown for 20 m/s and 30 m/s respectively.

Figures 10 and 11 show others simulation for a J-turn steer maneuver for a velocity of 20 m/s and a velocity of 30 m/s respectively. In these simulations, the responses of sideslip angle and yaw rate for the controlled vehicle track the desired values how in the previous experiment. As demonstrated by the simulation results, the proposed fuzzy logic controller enables stability control.

Table 3. Parameters of vehicle

m	Vehicle total mass	1298.9 kg
m_s	Vehicle sprung mass	1167.5 kg
a	Distance of c.g. from the front axle	1 m
b	Distance of c.g. from the rear axle	1.454 m
T_f	Front track width	1.436 m
T_r	Rear track width	1.436 m
h_{cg}	Height of the sprung mass c.g.	0.533 m
e	Distance of the sprung mass c.g. from the roll axes	0.4572 m
I_z	Vehicle moment of inertia about yaw axis	1627 kgm^2
I_{xxs}	Vehicle moment of inertia about roll axis	498.9 kgm^2
I_{xzs}	Sprung mass product of inertia	0 kgm^2
R_w	Wheel radius	0.35 m
I_w	Wheel moment of inertia	2.1 kgm^2
C_α	Cornering stiffness of one tyre	30000 N/rad
C_s	Longitudinal stiffness of one tyre	50000 N/unit slip
$K_{r,sf}$	Front roll steer coefficient	-0.2 rad/rad
$K_{r,sr}$	Rear roll steer coefficient	0.2 rad/rad
K_{RSF}	Ratios of front roll stiffness to the total roll stiffness	0.552
C_ϕ	Roll axis torsional damping	3511.6 Nm/rad/sec
K_ϕ	Roll axis torsional stiffness	66185.8 Nm/rad
ε_r	Road adhesion reduction factor	0.015 s/m
g	Acceleration of gravity	9.81 m/s^2
A	Stability factor	0.005
μ	Nominal friction coefficient between tyre and ground	0.9 and 0.5

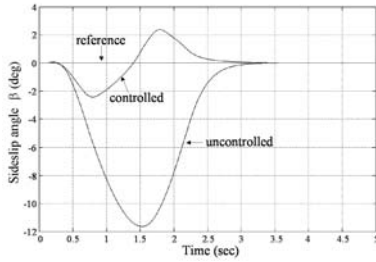

(a) Comparison between β value with and without controller, and β reference value

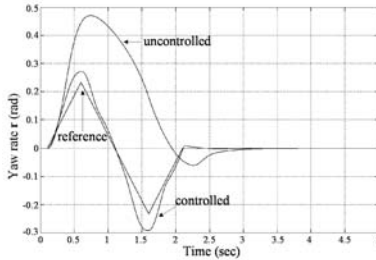

(b) Comparison between r value with and without controller, and r reference value

Fig. 8. Simulation results for a change line maneuver with a initial speed of 30 m/s on a dry surface

6. EPILOGUE

This paper presents a controller based on fuzzy-logic to ensure simultaneously vehicle handling and stability. This controller generates the brake torque necessary to control the yaw moment considering the performed steering maneuver. This is achieved by making the vehicle's yaw rate and sideslip angle trace their desired values. The fuzzy control has been selected because of its simplicity and its good performance to control non-linear systems.

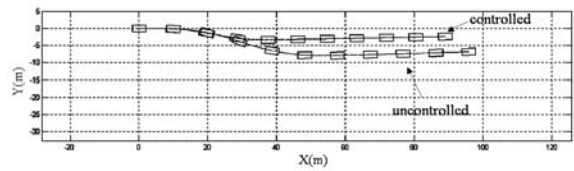

(a) Initial speed of 20m/s

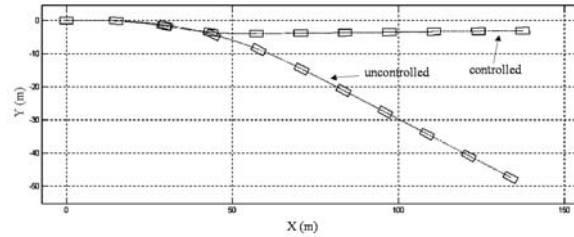

(b) Initial speed of 30m/s

Fig. 9. Vehicle trajectory for a change line maneuver on a dry surface

A number of simulations are carried out to evaluate the robustness of the proposed fuzzy logic controller for different steering maneuvers (change line and J-turn). Simulations results show that the controlled vehicle has a better performance when it is compared with the uncontrolled vehicle due to the system can be traced the desired response to a satisfactory degree. From the simulations we can observe that the controller has a better effect on the yaw rate than on the sideslip angle caused by non-linearities of tyres.

REFERENCES

- Boada, M.J.L., B.L. Boada, C. Castejon and V. Diaz (2005). A fuzzy-based suspension vehicle depending on terrain. *International*

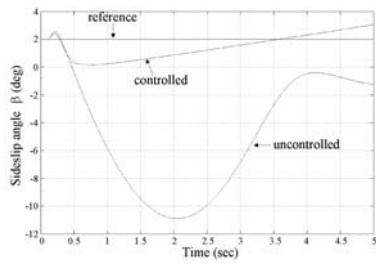

(a) Comparison between β value with and without controller, and β reference value

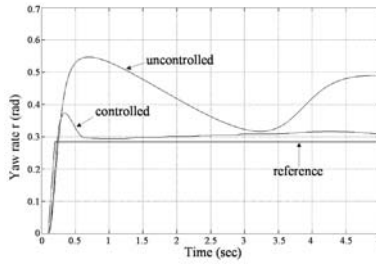

(b) Comparison between r value with and without controller, and r reference value

Fig. 10. Simulation results in a J-turn steer maneuver with a initial speed of 20 m/s on a dry surface

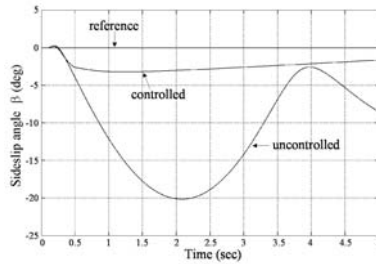

(a) Comparison between β value with and without controller, and β reference value

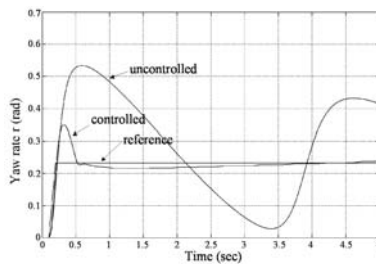

(b) Comparison between r value with and without controller, and r reference value

Fig. 11. Simulation results in a J-turn steer maneuver with a initial speed of 30 m/s on a dry surface

Journal of Vehicle Design. Accepted in June of 2004. In press.

Dugoff, Howard, P.S. Fancher and Leonard Segel (1970). An analysis of tire traction properties and their influence on vehicle dynamic performance. *SAE 700377* pp. 1219–1243.

Esmailzadeh, E., A. Goodarzi and G.R. Vossoughi (2003). Optimal yaw moment control law for improving vehicle handling. *Mechatronics*.

Esmailzadeh, E., G.R. Vossoughi and A. Goodarzi (2001). Dynamic modeling and analysis of a four motorized wheels electric vehicle. *Vehicle System Dynamics* **35**(3), 163–194.

Furukawa, Yoshimi and Masato Abe (1998). Direct yaw moment control with estimating side-slip angle by using on-board-tire-model. In: *AVEC'98*.

Hajjaji, A. El, A. Ciocan and D. Hamad (2004). Four wheel steering control by fuzzy approach. *Journal of Intelligent and Robotic Systems* **41**, 141–156.

Horiuchi, Shinichiro, Kazuyuki Okada and Shinya Nohtomi (1999). Improvement of vehicle handling by nonlinear integrated control of four wheel steering and four wheel torque. *JSAE Review* **20**, 459–464.

Park, Jong Hyeon and Woo Sung Ahn (1999). H-infinity yaw-moment control with brakes for improving driving performance and stability. In: *Proceedings of the 1999 IEEE/ASME International Conference on Advanced Intelligent Mechatronics*.

Ray, Laura R. (1997). Nonlinear tire force estimation and road friction identification: Simulation and experiments. *Automatica* **33**(10), 1819–1833.

Shino, Motoki, Naoya Miyamoto, YuQing Wang and Masao Nagai (2000). Traction control of electric vehicles considering vehicle stability. In: *AMC 2000-NAGOYA*. pp. pp.311 – 316.

Smith, Dirk E. and John M. Starkey (1995). Effects of model complexity on the performance of automated vehicle steering controllers: Model development, validation and comparison. *Vehicle System Dynamics* **24**, 163–181.

Yoshimura, T. and Y. Emoto (2003). Steering and suspension system of a full car model using fuzzy reasoning based on single input rule modules. *International Journal of Vehicle Autonomous Systems* **1**(2), 237–255.