

DECENTRALISED CONTROL OF A HIGH VOLTAGE DC SYSTEM USING GENETIC ALGORITHMS

Adel Farag* Herbert Werner* Martin Aten**

* *UMIST, Control Systems Centre
PO Box 88, Manchester M60 1QD, UK*

** *ALSTOM T&D PES Ltd. PO Box 27, Stafford, UK*

Abstract:

A procedure for the design and tuning of two control loops of a High Voltage DC system is presented. The controlled variables are direct current on the rectifier side and direct voltage on the inverter side. The dynamics of both control loops interact with each other and are determined by the overall properties of the combined AC/DC system. Constraints on the information available for feedback in each loop require a decentralised controller structure. Genetic Algorithms are demonstrated to be an efficient tool for the design and tuning of such a decentralised control system.

Keywords:

Decentralised control, power transmission, genetic algorithms

1. INTRODUCTION

This paper presents a procedure for the design and tuning of two control loops in a High Voltage DC transmission link using Genetic Algorithms. In the case of long transmission lines or cables, only local information is available for feedback control on each side of the link. In practice, the two controllers are usually tuned manually as lead-lag compensators using classical frequency response methods. This is an iterative trial-and-error procedure due to the dynamic interaction between the two sides, and it can be time-consuming to achieve good responses. An automated design and tuning procedure would result in faster project execution and lower engineering costs for tender and contract customisation.

Two features that make it difficult to employ modern optimal and robust control techniques for a systematic design procedure are the above mentioned constraint that only local information is available, and the high dynamic order of the physical plant model. The latter results in controllers of high order. For implementation purposes, this requires model or controller order reduction, and it may be difficult to achieve acceptable order reductions. The constraint on the use of information in a multivariable controller leads to the problem of decentralised feedback control. The optimal solution to this problem is known to be difficult and in general requires solving an infinite dimensional optimisation problem (Sourlas and Manousiouthakis, 1995).

In this paper, an alternative approach is taken to develop an automated design and tuning procedure: the use of Genetic Algorithms (GA). The strength of GA applied to this problem is that it can cope with high order models; moreover,

¹ The authors wish to thank *ALSTOM T&D PES* (Stafford, UK) for giving permission to publish this paper

constraints on the controller information structure can be easily incorporated.

This paper is organised as follows. Section 2 gives a brief description of HVDC systems and the control problem considered here. An automated design and tuning procedure using GA is presented in section 3. Simulation results are shown and compared with results achieved by manual design. Conclusions are drawn in section 4.

2. HIGH VOLTAGE DC SYSTEMS

High Voltage Direct Current (HVDC) systems are used in electrical power grids as a supplement to AC transmission. Power transfer by means of HVDC is used in case of (i) interconnecting asynchronous AC systems with different power frequencies, (ii) high voltage cables longer than about 30-80km and (iii) long overhead lines with lengths in excess of about 600km (Kundur, 1994). The system comprises two AC/DC power electronic converters separated by an equivalent impedance (Z_{DC}). On the AC side there are AC filters, while the AC grids can be represented by an equivalent impedance (Z_{AC}), as shown in Figure 1.

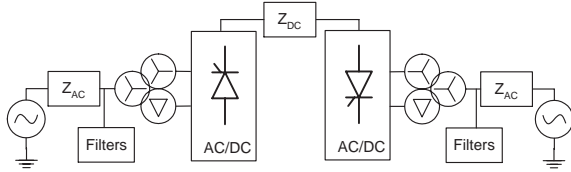

Fig. 1. High Voltage DC scheme

A linearised model for this plant is presented in (Aten *et al.*, 2001); the high dynamic order (35 state variables) reflects the large number of passive elements. This model has been linearised for nominal AC voltages (1pu) and nominal firing angles (rectifier firing angle $\alpha = 21^\circ$, inverter extinction angle $\gamma = 25.6^\circ$) and extensively validated against nonlinear EMTDC simulation for small changes. The uncertain time delays due to the firing of the valves are ignored, since they are small relative to the control bandwidth, which is typically up to about 30Hz. As a result of the AC/DC interactions, the linearised model has zeros in the right half plane.

The DC side impedance is determined by the properties of a transmission line or cable, if present. In the case of a back-to-back scheme, where the two converters are physically close, the DC side impedance is just a conductor. The equivalent inductance of the converter transformers is modelled within the DC impedance. For a given HVDC scheme the DC impedance is normally accurately known, however this is not the case

with the AC system impedance. The latter is determined by the transmission lines, generators and loads present at a certain time. In relation to this the Short Circuit Ratio (SCR) is defined as the ratio between Short Circuit Level ($V^2/|Z_{AC}|$) and the DC power transmitted (Kundur, 1994). This parameter is uncertain within specified bounds and can suddenly change significantly when, for example, a transmission line is switched out to clear a fault. In the present work a short circuit ratio of 2.5 was assumed on both sides.

HVDC Control Strategies

Conventional HVDC control strategies consist of a hierarchy of different control functions. Two inner control loops are designed for control of direct current (I_{DC}) on the rectifier side and direct voltage (V_{DC}) on the inverter side. Depending on AC operating conditions, it may be necessary to enforce firing angle limit control instead of the default V_{DC} and I_{DC} control loops. Slower high level controllers co-ordinate the references of the inner control loops to change active and reactive power flow, in order to assist the AC systems. Figure 2 shows the structure of the control system, where K_{11} , K_{12} , K_{23} and K_{24} represent transfer functions of dynamic compensators, and g_1 and g_2 are constant gains. The proposed GA design procedure is based on the same controller configuration.

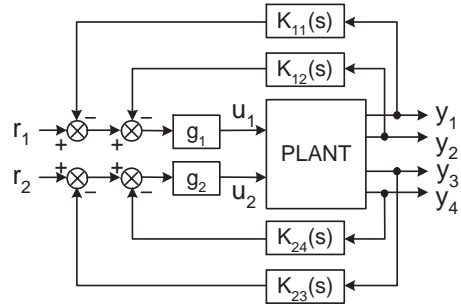

Fig. 2. Structure of decentralised controller

As indicated in Figure 2, controlled outputs are y_1 (direct current I_{DC1}) and y_3 (direct voltage V_{DC2}), and control inputs are u_1 (ϵ_1 , the input controlling the phase-locked oscillator on side 1) and u_2 (ϵ_2 on side 2). Additional measurements available for feedback are y_2 (high-pass filtered V_{DC1}) on side 1 and y_4 (high-pass filtered I_{DC2}) on side 2. The output y_1 should track r_1 (the current order I_{ord}) and y_3 should track r_2 (the voltage order V_{ord}).

On each side the outputs of the constant gain blocks labelled g_1 and g_2 are passed to phase locked oscillators, which send firing pulses to the thyristor valves in the converter bridges. The

resulting firing angles determine the amount of direct voltage and direct current flowing through the link. The measured signals y_2 and y_4 are generated by passing V_{DC1} and I_{DC2} , respectively, through so-called wash-out filters, in order to eliminate DC offsets in the response that are present in real-life measurements in steady state. These DC offsets would interfere with the tracking requirements of the controlled outputs.

The phase-locked oscillators act as integrators in the control loop. Even though the decentralised controller structure imposes a constraint, it facilitates the design on the other hand because together with the integral action of the phase-locked oscillator on each side it helps to achieve zero steady-state error after step changes.

The dynamics of both control loops interact with each other and are determined by the overall properties of the combined AC/DC system. It is common practice to design the inner control loops for HVDC sequentially by trial and error, using classical methods. Applications of modern control techniques have been reported recently. (Daneshpooy *et al.*, 1997) describes how Fuzzy Logic principles can be applied to the HVDC control problem. H_∞ controller design was used on the inverter side only in (Jovcic *et al.*, 1999). Genetic algorithms have been proposed for the design of a PID controller for a HVDC system in (Wang *et al.*, 2000), where a regulator problem is considered. The combination of GA with EMTDC as a tool for multi-variable controller design is studied in (Reformat *et al.*, 1998). Further applications of GA to the controller design for power transmission systems are reported in (Leung and Chung, 2000), (Chung and Li, 2001) and (Mantovani *et al.*, 2001). GA have also been applied to design a decentralised controller for power system damping (Taranto and Falcao, 1998), where regulation of a pre-stabilised system is considered. The aim of the present work was to investigate whether GA provide an efficient way of designing and tuning decentralised controllers for HVDC systems.

3. DECENTRALISED CONTROL USING GENETIC ALGORITHMS

Genetic algorithms have recently found extensive application in solving global optimisation problems. They are parallel, global search techniques that emulate natural genetic operators. Because GA simultaneously evaluate many points in the parameter space, they are more likely to converge toward the global solution.

The structure of the standard GA that has been used in this work is shown in Figure 3. Crossover and mutation operations have been carried out on

binary mapped numbers. For details on how the basic three operation of GA *Selection*, *Crossover*, *Mutation* are performed, the reader should refer to (Holland, 1992). The fitness evaluation process that translates design specifications into controller parameters, is the main contribution of this paper and is described below.

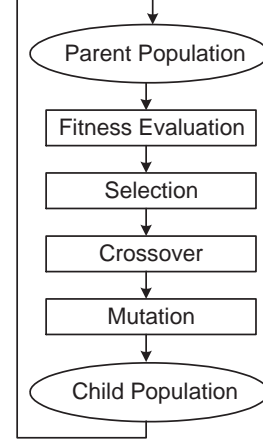

Fig. 3. Genetic algorithm

The plant to be controlled has two inputs and four outputs; the first and the third output are required to track a reference signal. Figure 4 shows a step response. (The response is normalised on a step value that is 5% of nominal rated I_{DC} and V_{DC} , which means that the plant can still be considered linear.) The closed-loop system has to satisfy the following requirements:

- Settling time less than 100 msec from reference r_1 and r_2 to y_1 and y_3 , respectively.
- Rise time less than 30 msec from reference r_1 and r_2 to y_1 and y_3 , respectively.
- Maximum overshoot of 20% on output y_1 and y_3 .
- Maximum disturbance peak of 30% on output y_1 or y_3 when a step input is applied on r_2 or r_1 , respectively.

According to Figure 2, the controller transfer function matrix from the output vector $[y_1 \ y_2 \ y_3 \ y_4]^T$ to the input vector $[u_1 \ u_2]^T$ can be written as

$$K(s) = \begin{bmatrix} g_1 K_{11}(s) & g_1 K_{12}(s) & 0 & 0 \\ 0 & 0 & g_2 K_{23}(s) & g_2 K_{24}(s) \end{bmatrix}$$

Here the following choices were made

$$\begin{aligned} K_{11}(s) &= \frac{T_1 s + 1}{\alpha_1 T_1 s + 1} \\ K_{12}(s) &= k_{12} \\ K_{23}(s) &= \frac{T_3 s + 1}{\alpha_3 T_3 s + 1} \\ K_{24}(s) &= k_{24} \end{aligned} \quad (1)$$

thus eight parameters are used to characterise the fitness of a given controller $K(s)$, namely k_{12} , T_1 , α_1 , k_{24} , T_3 , α_3 , and the two gains g_1 and g_2 . The fitness evaluation scheme is given below.

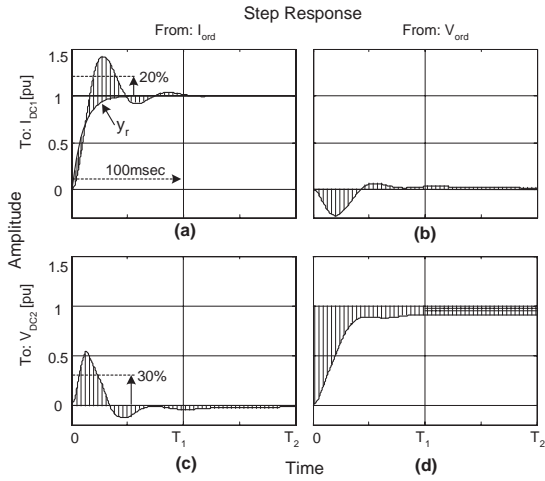

Fig. 4. Tuning the controller parameters

Fitness Evaluation Scheme

Assume that a unit step is applied as reference input r_1 (i.e. $r_1 = 1, r_2 = 0$), and y_r is the desired response of y_1 . As performance measure, the integral absolute error over a specified time horizon is used

$$J_{u_1} = \int_0^{T_1} |y_r - y_1| dt + W \int_{T_1}^{T_2} |y_r - y_1| dt$$

The time horizon has been divided into two sub-intervals $0 \rightarrow T_1$ and $T_1 \rightarrow T_2$, see Figure 4. T_1 is selected to be the required settling time. By introducing a weight $W > 1$, it is possible to penalise the period $T_1 \rightarrow T_2$ separately, which can be used to suppress steady-state error.

In Figure 4.a the area between desired and actual output is marked. The signal y_r can be generated by applying a step input to a pre-selected system such as

$$G_r = \frac{1}{\tau_r s + 1}$$

This approach allows to control the rise time of the closed-loop system by varying τ_r .

So far, this fitness evaluation scheme neglects the cross-coupling effects from input u_1 (u_2) on output y_3 (y_1). However, as indicated in Figures 4.b and 4.c, cross-coupling can be taken into account by introducing another term into the penalty function

$$J_{u_1} = \int_0^{T_1} |y_r - y_1| dt + W \int_{T_1}^{T_2} |y_r - y_1| dt + \int_0^{T_2} |0 - y_3| dt$$

If the scheme is used in this form, the resulting optimal controller minimises the error area, but still allows overshoot larger than the required bound. To prevent this, the following modification is implemented:

$$\bar{J}_{u_1} = \begin{cases} J_{u_1} & \text{if ok} \\ (1 + n\beta)J_{u_1} & \text{if not ok} \end{cases}$$

where "ok" means that all overshoot requirements are satisfied, and "not ok" means that one or more of the overshoot requirements are not satisfied. The remaining variables are

β : percentage by which the cost \bar{J}_{u_1} is increased, where $0.2 \leq \beta \leq 0.5$.

n : number of unsatisfied overshoot constraints (maximum 4).

In a similar manner, assuming that a step input is applied as reference r_2 (i.e. $r_1 = 0, r_2 = 1$), the performance measure can be written as

$$J_{u_2} = \int_0^{T_1} |y_r - y_3| dt + W \int_{T_1}^{T_2} |y_r - y_3| dt + \int_0^{T_2} |0 - y_1| dt$$

The designer has to specify which objective function is used to represent the fitness of the controller. One way of doing this is to consider the sum of cost in both channels:

$$J = \bar{J}_{u_1} + \bar{J}_{u_2}$$

An alternative approach is to minimise the worst cost of both channels:

$$J = \max(\bar{J}_{u_1}, \bar{J}_{u_2})$$

This latter approach was implemented in this paper.

Finally, since GA is a cost *maximisation* tool, the cost J_i cannot be used directly to represent the fitness of a given controller $K_i(s)$ in a "controller population". It can however be transformed as follows:

$$f_i = T - J_i$$

where T is the sum of the maximum and minimum fitness of the current population:

$$T = \min_{i \in [1, n]} (J_i) + \max_{i \in [1, n]} (J_i)$$

This linear transformation means the controller which achieves the minimum cost has the maximum fitness and *vice versa*.

A population of 40 controllers was constructed randomly with maximum number of iteration of 300. The probabilities of crossover and mutation were selected as $P_c = 0.65, P_m = 0.005$. The time horizons were chosen as $T_1 = 100$ msec and $T_2 = 200$ msec. For this choice, note that if T_2 is

selected too small (say $T_2 = 120$ msec), the search algorithm is not able to differentiate between a good and a bad controller as far as steady state error is concerned. On the other hand, making T_2 too large will slow down the search procedure. A good compromise between the overshoot and settling time requirements was found to be $W = 10$, $\beta = 0.3$.

With these parameters and the choice $\tau_r = 10$ msec, the GA tuning procedure returns a controller $K(s)$ with parameter values

$$\begin{aligned} k_{12} &= 0.638 & k_{24} &= 2.6147 \\ T_1 &= 0.00797 & T_3 &= 1.0000 \\ \alpha_1 &= 0.1024 & \alpha_3 &= 0.9685 \\ g_1 &= 0.606 & g_2 &= 0.2048 \end{aligned} \quad (2)$$

Figure 6 shows the closed-loop responses of the linearised small-signal model proposed in (Aten *et al.*, 2001) with this controller to unit step changes of I_{ord} and V_{ord} . For comparison, the response achieved with a manually designed lead-lag compensator is shown in the same plot. The controller (2) was also tested in nonlinear simulation on EMTDC. Figure 7 shows the responses to 5% step changes. Note that the I_{DC} and V_{DC} signals contain multiples of 12th harmonics (600Hz, 1200Hz, 1800Hz etc.) due to the switching effect of the thyristor 12 pulse converter valve bridges, which are modelled in detail in EMTDC. The response with the manually designed controller is shown in Figure 8.

Performance measures are listed in the table below; to illustrate the effect of the tuning parameter τ_r , the data for a controller obtained by applying GA with $\tau_r = 20$ msec has been included. As expected the controller (2) results in a closed-loop response faster than the controller obtained with $\tau_r = 20$ msec, but the price paid for a faster response is overshoot. Finally, the table shows that the first controller outperforms the manually designed lead-lag compensator in every aspect.

A final comment on the computational efficiency of the proposed method. A typical average cost variation is shown in Figure 5, where

$$J_{av} = \sum_{i=1}^{n=40} J_i / N$$

The best controller is saved and always updated over coming new generations. It is clear that as the average cost of the whole population improves, the best cost (or fitness) is also improved. It turned

	settling time $u_1 : y_1$	settling time $u_2 : y_3$	rise time $u_1 : y_1$	rise time $u_2 : y_3$	overshoot $u_1 : y_1$	overshoot $u_2 : y_3$	overshoot $u_1 : y_3$	overshoot $u_2 : y_1$
$\tau_r = 10$ msec	24	33	18	15	3.0 %	2.0 %	32.0 %	% 33.0
$\tau_r = 20$ msec	78	74	78	74	1.0 %	1.0 %	29.0 %	% 20.0
manual design	69	74	22	22	14.0 %	11.0 %	39.0 %	% 37.0

Table 1. Performance measures

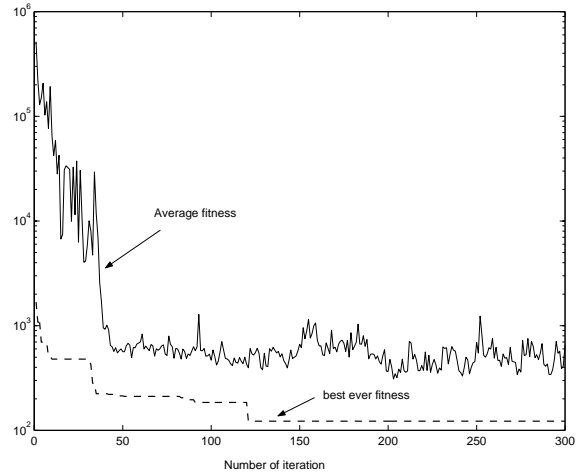

Fig. 5. Fitness over 300 generations, $P_{mut} = 0.003$, $P_{cr} = 0.65$, number of bits = 16

out that 50 iterations are always sufficient to bring the average cost close to its optimal value.

4. CONCLUSIONS

Genetic algorithms have been used for the design of decentralised control of direct current on the rectifier and direct voltage on the inverter side. It has been demonstrated to be an efficient tool to tune the control parameters for good performance. This way the tuning process of a simple first order controller can be automated, while there is flexibility to shape the step responses in a direct manner.

Genetic algorithms are very powerful in cases where modern control techniques such as LQG or H_∞ design are difficult to apply - in the present case due to the high dynamic order and the constraint on the controller structure. On the other hand, a drawback is the computation time required: each generation takes around 10 sec on a 900 MHz AMD Duron; a complete run of 300 iteration takes about 50 min. However, increasing computing power will reduce the significance of this aspect. A further problem with GA is that they are not guaranteed to converge to the optimal solution, even though they will lead to suboptimal controllers close to the optimum.

Current work is directed at extending the design procedure to include robustness against variation in short circuit levels, and different operation conditions with different firing angles.

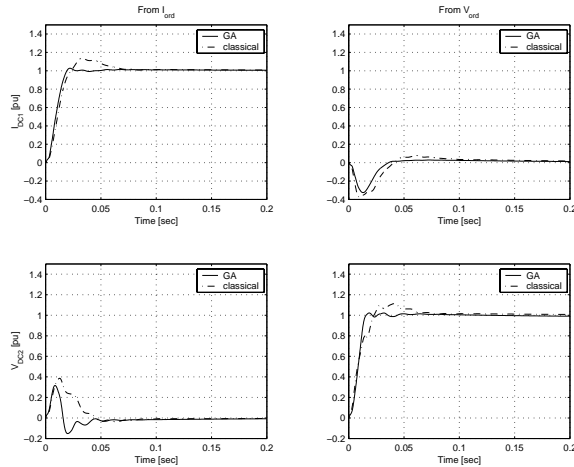

Fig. 6. Step responses with controller (2) and for comparison a manually designed controller in simulation with a linearized small-signal model

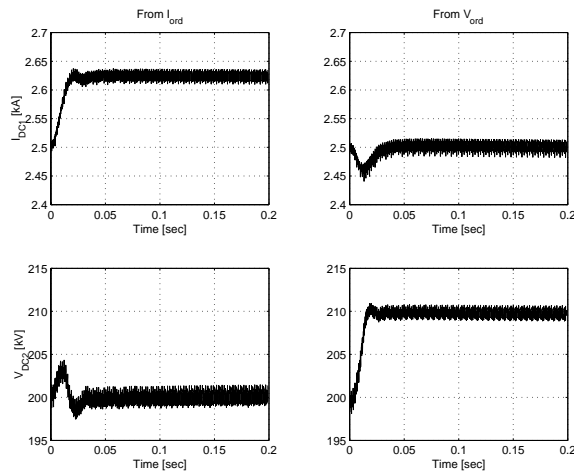

Fig. 7. Response to 5% step changes with controller (2) in nonlinear simulation on EMTDC. The response contains harmonics.

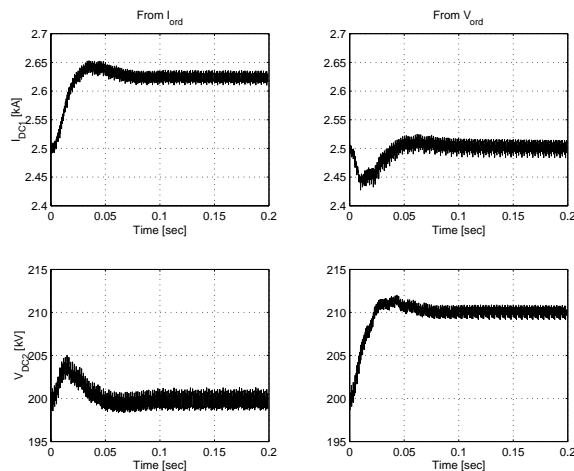

Fig. 8. Response to 5% step changes with manually designed controller in nonlinear simulation on EMTDC. The response contains harmonics.

REFERENCES

- Aten, M., K. Abbott and N. Jenkins (2001). Developments in modelling and analysis of HVDC control systems. In: *EPE 2001 Conference*. Graz, Austria.
- Chung, T.S. and Y.Z. Li (2001). A hybrid approach for OPF with consideration of FACTS devices. *IEEE Power Engineering Review* **21**(2), 47–50.
- Daneshpooy, A., A.M. Gole, A.G. Chapman and J.B. Davies (1997). Fuzzy logic control for HVDC transmission. *IEEE Trans. Power Delivery* **12**(4), 1690–1697.
- Holland, J.H. (1992). *Adaptation in natural and artificial systems. An introductory analysis with applications to biology, control and artificial intelligence*. Advances in Design and Control. MIT Press. Cambridge, MA USA.
- Jovicic, D., N. Pahalawaththa and M. Zavaahir (1999). Inverter controller for very weak receiving AC systems. *IEE Proceedings - Generation, Transmission and Distribution* **146**(3), 235–240.
- Kundur, P. (1994). *Power system stability and control*. McGraw-Hill. New York.
- Leung, H.C. and T.S. Chung (2000). Optimal power flow with a versatile FACTS controller by genetic algorithm approach. In: *IEEE Power Engineering Winter Meeting*. pp. 2806–2811.
- Mantovani, J.R.S., S.A.G. Modesto and A.V. Garcia (2001). VAR planning using genetic algorithm and linear programming. *IEE Proceedings Generation, Transmission and Distribution* **148**(3), 257–262.
- Reformat, M., E. Kuffel, D. Woodford and W. Pedrycz (1998). Application of genetic algorithms for control design in power systems. *IEE Proceedings Generation, Transmission and Distribution* **145**(4), 345–354.
- Sourlas, D. and V. Manousiouthakis (1995). Best achievable decentralized performance. *IEEE Trans. Automatic Control* **40**(11), 1858–1871.
- Taranto, G.M. and D.M. Falcao (1998). Robust decentralised control design using genetic algorithms in power system damping control. *IEE Proceedings Generation, Transmission and Distribution* **145**(1), 1–6.
- Wang, Y.P., D.R. Hur, H.H. Chung, N.R. Watson, J. Arrillaga and S.S. Matar (2000). Design of an optimal PID controller in AC-DC power system using modified genetic algorithm. In: *Proc. Power System Technology*. pp. 1437–1442.