

REAL-TIME IMPLEMENTATION OF MULTIRATE CONTROL TECHNIQUES FOR AN ICCS

V. Casanova, J. Salt

*Department of Systems Engineering and Control (DISA)
 Universidad Politécnic de Valencia.
 Cno de Vera s/n, Valencia 46071, Spain
 e-mail : vcasanov@isa.upv.es , julian@isa.upv.es*

Abstract: Integrated Communication and Control Systems (ICCS) are a special kind of control loops, in which a shared medium is used to perform the communication between controller and controlled plant. The random access delays and the lack of synchronization involved in these systems are a potential cause of instability. The critical treatment of the time management in this kind of systems needs real-time tools to perform the control task. The aim of this paper is the practical implementation of multirate control techniques, to solve the stability problems due to the shared link. *Copyright © 2002 IFAC*

Keywords: Implementation, delay analysis, distributed control, frequency conversion, multirate, real-time tasks.

1. MULTIRATE CONTROL OF AN ICCS

Integrated Communication and Control Systems (ICCS) are characterized by the use of a non-exclusive communication link (e.g. a shared bus). Figure 1 shows a representation of an ICCS. Whenever an interchange of information (samples or control actions) between controller and plant has to be done, the sender device (sensor or controller) demands the use of the shared medium. Depending on the information traffic and the number of devices sharing the link, a certain random delay will appear. See (Halevi and Ray, 1988 ; Casanova and Salt, 1999) for more details on ICCS.

Two of the most important problems on ICCS are caused by the loss of information due to the random access delay (Casanova and Salt, 2000) and by the combination of these delays with the probable lack of synchronization between controller and plant (Salt and Casanova, 2000). One feasible solution to these problems involves using multirate techniques. A dual-rate controller can be used in order to allow different frequencies in the controller-to-actuator link (CA) and in sensor-to-controller one (SC).

The main idea is to employ a high frequency link to apply the control actions and a low frequency one to provide the controller with the necessary information to take its decisions. To allow these different frequencies, the priority of the controller link demands must be higher than the sensor one. These frequencies (and so the access priorities) are selected to be high enough to accomplish desired control specifications and low enough to avoid the loss of information due to the ICCS randomness.

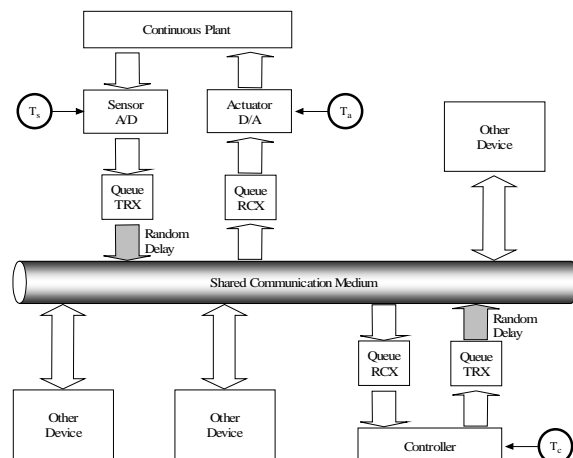

Figure 1 .- ICCS scenario

2. REAL-TIME ENVIRONMENT

Obviously, the best way to test the proposed multirate control techniques is using a real ICCS. In an industrial environment, where any kind of shared communication media (Profibus, CAN networks ...) is used with a lot of sensors and actuators, random access delays and lack of synchronization appears in a natural way. Nevertheless, large industrial systems are not usually available to force situations in which stability is seriously affected.

So, instead of using a real ICCS, the randomness has been generated by the computer playing the role of the controller. In a conventional implementation of a computer control loop, the controlled variable is sampled (AD) at a constant rate and the control algorithm uses this information to calculate a new control action, which is immediately applied to the continuous plant (DA). This conventional control loop becomes an ICCS if a random delay is inserted between the sampling instant and the one in which the sample is available to be used by the controller, and another random delay is inserted between the generation of a new control action and the instant in which is ready to be applied. The time skew problem appears if the sampling and application instants are not synchronized with the control clock. Such kind of control implementation needs a good time management. The bounds of random access delays and the sampling and application instant must be precisely determined to assure ICCS conditions. So, a real-time implementation is strongly recommended.

Usual programming languages, running over conventional operating systems, have certain limitations in time control. The only way to assure that the ICCS events happen in the desired instants is by using a real-time operating system or a real-time tool running over usual systems. The second option has been chosen to get the results presented in this paper. The Real-Time Windows Target (RTWT) is a toolbox of Matlab/Simulink able to generate real-time code that runs over Windows operating systems. The generated code runs in real-time, at ring zero to avoid that any usual Windows task could interrupt the execution. RTWT can generate code to access standard I/O boards, which is needed to implement the control of a continuous plant. The controller transfer function and additional operations to imitate ICCS conditions are implemented with usual Simulink blocks. As real-time run is guaranteed, the bounds of random access delays and the time skews can be precisely determined by model parameters.

Figure 2 shows the Simulink model for a dual-rate controller with random access delay and time skew in both links. Blocks named 'Analog Input' and 'Analog Output' are used to reach analogical world through the I/O board. Blocks named 'Clk_S' and 'Clk_A' generate the sensor and actuator clock signals. A parameter in these blocks allows including a certain time skew. Blocks 'Clk_C1' and 'Clk_C2'

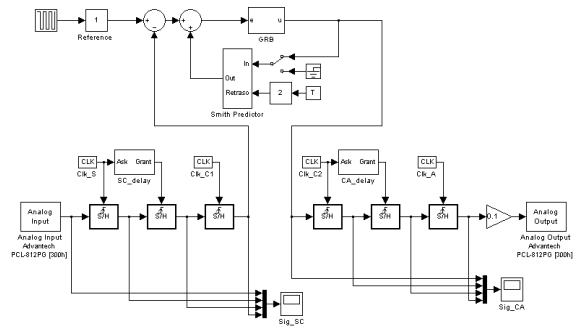

Figure 2.- ICCS implementation in RTWT

generate controller clock signals for the dual_rate controller. Random access delays are generated by blocks named 'SC_delay' and 'CA_delay', in which the upper and lower bounds of randomness can be determined. Block named 'GRB' includes the transfer functions of the dual-rate controller. This controller can be modified with a Smith predictor to compensate the influence of ICCS delays. With this implementation, the influence of both, random access delay and lack of synchronization, can be studied on a real plant without having a real shared link.

3. DUAL-RATE CONTROLLER DESIGN

Multirate techniques implemented in this paper requires a dual-rate controller, able to generate in its output a discrete control signal with different sampling period than the feedback signal in its input. In this case, the output frequency will be higher than the input one. The main goal is that the loop behaviour with the dual-rate controller imitates the one with a single-rate controller, operating at fast frequency. The system output in the fast sampling instants is the following one:

$$Y_{SR}(z) = R(z) \frac{G_R(z) \cdot G_P(z)}{1 + G_R(z) \cdot G_P(z)} = R(z) \cdot M(z)$$

$G_P(z)$ is the discrete equivalent dynamics of the plant to be controlled, $G_R(z)$ is any kind of discrete single-rate controller and $R(z)$ is the loop reference signal. As described in (Salt and Albertos, 2000 ; Albertos *et al.* 1996), the dual-rate controller is composed by a slow part (operating at low frequency) a fast part, (operating at high frequency) and a frequency conversion stage to convert the slow output signal into a fast input one. The easiest way to perform this frequency conversion is by using a *expand* operator between slow and fast parts. Each one of the slow samples is converted a group of N fasts samples (the slow sample and N-1 zeros), being N the multiplicity of the controller. The expanded signal, after being processed by fast part of the controller, is applied to $G_P(z)$ to get the fast output of the plant. This output has to be converted into a slow frequency signal. Only one of each group of N samples can be used as information feedback, as SC link operates in low frequency. This can be modelled with a *skip* operator. More information on *expand* and *skip* operators can be founded in (Coffey and Williams, 1966).

$$Exd\{Y(z)\}_N = \frac{1}{N} \sum_{k=0}^{N-1} Y(e^{j2\pi k/N} \cdot z^{1/N}) \quad ; \quad Skp\{Y(z)\}_N = Y(z^N)$$

The feedback signal of the dual-rate control loop can be modelled as follows:

$$Y_{DR}(z) = Exd\left\{\left\{R(z) - Skp\{Y(z)\}_N\right\}_N\right\} \cdot G_{RB}(z) \cdot G_P(z)$$

This signal must be equal to $Y_{SR}(z)$ to get the same behaviour than with fast single-rate controller, but with slow frequency in the feedback. It can be shown that fast and slow parts (with a *expand* operator between them) of dual-rate controller are as follows:

$$G_{RL}(z) = \left(\frac{1}{R(z)}\right) \frac{R(z)}{R(z) - Skp\{R(z) \cdot M(z)\}_N}$$

$$G_{RR}(z) = (R(z)) \frac{G_R(z)}{1 + G_R(z) \cdot G_P(z)}$$

Assuming that the reference is a step, the part in brackets in the previous expressions can be removed if the *expand* operator is replaced by a *repeat* operator, which replicates N times each slow sample, instead of filling with zeros, to get a fast signal.

$$Rpt\{Y(z)\}_N = Exd\left\{\left\{\frac{Y(z)}{z-1}\right\}_N\right\} \frac{z}{z-1}$$

4. SYSTEM DESCRIPTION

The previously described implementation of an ICCS control system has been applied to a real plant. The results presented in the following sections have been obtained using a DC motor as continuous plant. The motor shaft position, measured with a sensor, is the variable to control. In order to design an appropriated controller, the plant dynamics has been identified. The transfer function that models the plant behaviour is the following one (time constant in seconds):

$$G_p(s) = \frac{603.7}{s(s+33.5)}$$

A conventional PID controller has been designed to reach certain closed-loop specifications (0.707 damping ratio and 0.2 seconds settling time). This PID is going to be digitally implemented, so it must be converted into a discrete system. A sampling period of at least 10 msec is needed to get a good achievement of continuous behaviour. With this period the discrete transfer function of controller is:

$$G_R(z) = \frac{3.045 \cdot z^2 - 4.515 \cdot z + 1.5}{z^2 - z}$$

Figure 3 shows the system behaviour with ideal conditions (absence of access delays and perfect synchronization), using a single rate controller. To solve the stability problems caused by ICCS randomness, multirate techniques has been proposed. From the discrete equivalent dynamics of the DC motor and the single-rate PID, the transfer functions

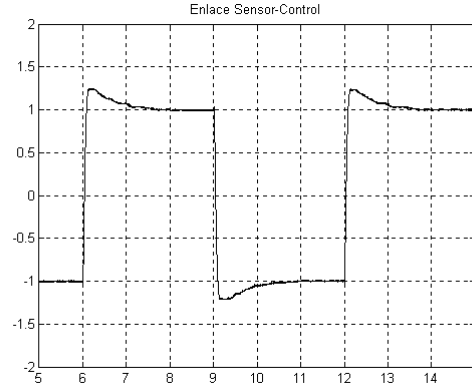

Figure 3 .- Single-Rate controller

of the slow and fast parts of the dual-rate controller can be obtained. The following functions are related to the case of step references and a multiplicity N=5 (i.e. sensor frequency is five times than application one) has been used:

$$G_{RL}(z) = \frac{z^4 - 1.229z^3 + 0.3996z^2 - 0.09037z}{z^4 - 1.937z^3 + 0.9024z^2 + 0.04147z - 0.006485}$$

$$G_{RR}(z) = \frac{3.045z^4 - 9.614z^3 + 11.12z^2 - 5.558z + 1.012}{z^4 - 2.597z^3 + 2.312z^2 - 0.7514z + 0.03817}$$

This dual-rate controller assumes that a rate conversion stage (*repeat* operator) is implemented between slow and fast parts. The results using the dual-rate controller instead of the fast single-rate one are quite similar. The differences come from the inaccuracy of the plant model, used to get the dual-rate controller.

5. ICCS WITH RANDOM ACCESS DELAY

In a real ICCS, information (samples and control actions) can not be transmitted until the shared link is granted to the sender device (sensor or controller). Due to the random nature of the information traffic in the shared link, a certain random access delay appears. If the upper bound of the access delay is not greater than the sampling period, none of the samples/actions will be lost while waiting for the link grant. They will arrive at the receiver device in a random instant, located between two consecutive captions/generations. As the receiver collects/applies the sample/action with a constant rate, the observed delay will be constant and equal to two sampling periods (one for each of the links). This constant delay can be compensated with any kind of delay compensation techniques, like the well-known Smith predictor (Smith, 1958). Figure 4 shows the results over the real system in these conditions. During the first half of the time, the delay is not compensated and its influence on the system stability is clear. The Smith predictor is activated, to compensate the delay, in the second half and the system behaviour tends to the one without access delay (figure 3), Figure 5 shows a detail of the signals in the SC link (upper graphic) and CA link (lower graphic). In these details, asterisks are used to mark the time in which a

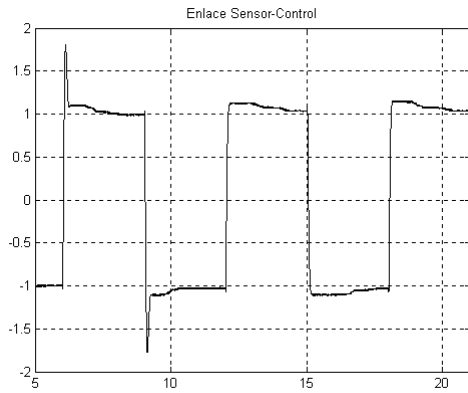

Figure 4 .- Single-Rate with small access delay

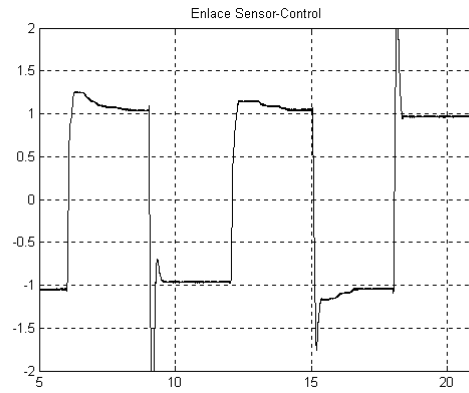

Figure 6 .- Single-Rate with large access delay

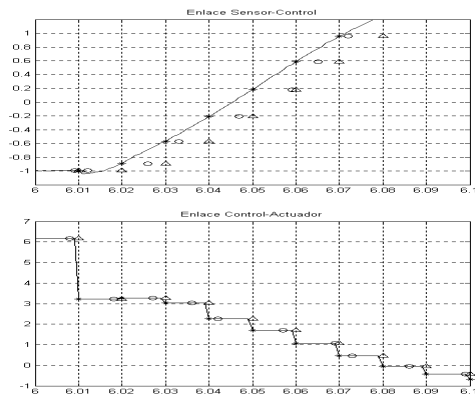

Figure 5 .- Random access delay

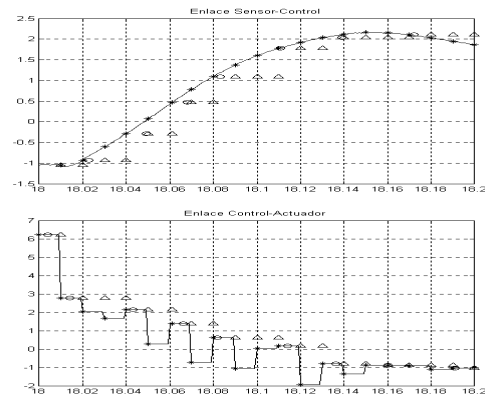

Figure 7 .- Information loss

sample is captured or an action is generated. Circles indicate the time in which the sample/action gains access to the link (arrival at the controller/actuator reception queue). Triangles indicate the time in which the sample/action is collected/applied. Despite the randomness of the arrival time, from the point of view of the receiver, the delay is constant and equal to one sampling period for each link.

In the previous example, the random access delay was always smaller than the sampling time. The problem is different if the upper bound of the delay exceeds the maximum desirable sampling period, according to the system specifications. Some of the samples/actions will be lost while they are waiting for the link grant. Figure 6 shows the behaviour in these conditions. The irregularity of this behaviour is caused by the randomness of access delay. If the delay is small no information is lost and the response tends to be as before. When the delay is large some samples/actions are lost, causing potential instability. In this example, the upper bound of access delay is 30 msec. As the sampling period is fixed to 10 msec, one or two samples/actions can be lost in each communication trial. This loss of information can be seen in the details shown in figure 7. Increasing the sampling period to avoid the loss of information is not a good solution because the control frequency will not be high enough to accomplish desired loop specifications. The proposed solution (Casanova & Salt, 2000) involves increasing the priority of controller link demands (to reduce the access delay) until the bound of access delay is smaller than the

sampling period (T_a). This involves reducing the priority on the other side of the link (sensor demands) and, to avoid losing samples the sampling period of this link (T_s) will be increased as much as necessary. So, as the frequency in SC link is different than in CA one, a dual-rate controller is needed. As the random delay is always smaller than the sampling period, no information is lost and the observed delay is constant and equal to $T_s + T_a$ (which means, SC plus CA sampling periods).

This constant delay can be compensated with a Smith predictor. Figure 8 shows the response using a dual-rate controller with Smith predictor. The upper bound of CA delay has been reduced from 30 to 10 msec and the SC one has been increased from 30 to 50 msec. So, the multiplicity of the controller is $N=5$ and 60 msec must be compensated. The Smith predictor is activated in the second half of the figure, avoiding the influence of the delay in the stability. Again, the difference between this behaviour and the one in ideal conditions (figure 3) is caused by inaccuracy of the plant model, which is used in dual-rate controller and Smith predictor. Details in figure 9 show that no information is lost and the different frequencies in both links (note the different time axis).

6. ICCS WITH TIME SKEW

All the situations considered until now assume a perfect synchronization between the three ICCS clocks (i.e. at the same time a sample is collected, an

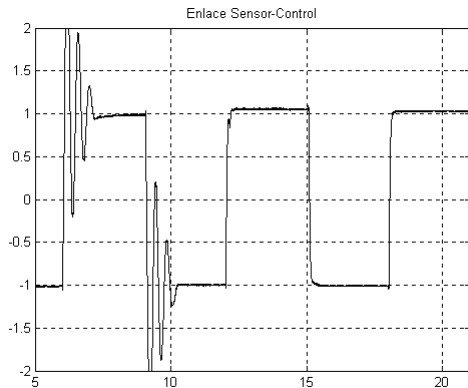

Figure 8 .- Dual-Rate with access delay

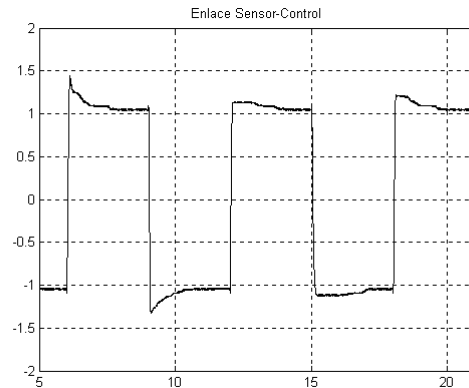

Figure 10 .- Single-Rate with time skew

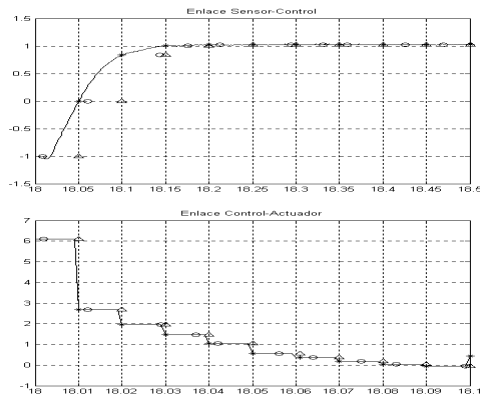

Figure 9 .- Different rate signals

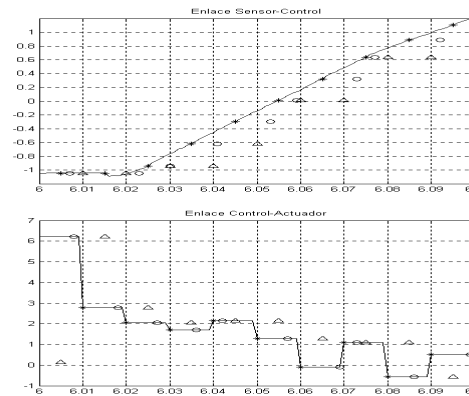

Figure 11 .- Vacant sampling / Message rejection

action is generated, and another is applied). In a real ICCS this perfect synchronization will be difficult to achieve. One possible (and usual in fieldbuses like Profibus) situation is that sampling and application instants are determined by demand of the controller. So, there are no physical sensor and actuator clocks. Whenever it is time to capture a new sample, the controller sends a message to the sensor, ordering the caption. The same happens for action applications. These demand messages have to be sent through the shared link, and will be affected by access delay, which becomes the time skew. With this statement is reasonable to think that the maximum skew will be the upper bound of access delay.

When the time skew, which is going to be considered constant and known, is present together with the random access delay, some information can be lost due to the vacant sampling and message rejection phenomena. In this case, some samples/actions are lost, not while waiting for the link grant but while waiting to be collected/applied. In the same way some of the samples/actions are reused because the new information did not arrive in time to be collected/applied. Figure 10 shows the behaviour with the single-rate controller, random access time smaller than the sampling period and 50% time skew in both links. As can be seen, the response is irregular because is affected by access delay randomness. Several vacant samplings (sample/action is collected/applied two times) and message rejections (sample/actions arrive but are not collected/applied) can be seen in details of figure 11.

To avoid the problems caused by vacancies and rejections, multirate techniques have been proposed. (Salt & Casanova, 2000). The main idea is to assure that all the samples/actions are collected/applied with the same antiquity (i.e. the time between caption and collection is constant and so it is the time between generation and application). To reach this goal the SC sampling period is doubled to assure that, even in the worst case, when the controller collects a sample it is a new one. In the other link the solution is different. As CA sampling period can not be increased, because control frequency would not be high enough, the upper bound of access delay is decreased (rising the priority of controller link demands) until access delay is smaller than the half of sampling period. Moreover, as in this link the skewed clock is the receiver one, every action must be held during the first half of each CA period, to assure that every applied action is a new one. With this control structure, which obviously implies a dual-rate controller, every sample is collected with $T_s - \Delta_s$ antiquity (where Δ_s is the sensor skew) and every action is applied with $T_a + \Delta_a$ antiquity (Δ_a is the actuator skew). So, the observed delay is constant and equal to $T_s - \Delta_s + T_a + \Delta_a$, and it can be compensated with a Smith predictor.

The following example assumes an ICCS with random access delay smaller than 10 msec, constant time skew (2.5 msec in sensor and 7.5 msec in actuator). Priority of controller demands has been increased so that access delay is always smaller than 5 msec, which means that SC access delay will be smaller than 15 msec. So, SC sampling period must

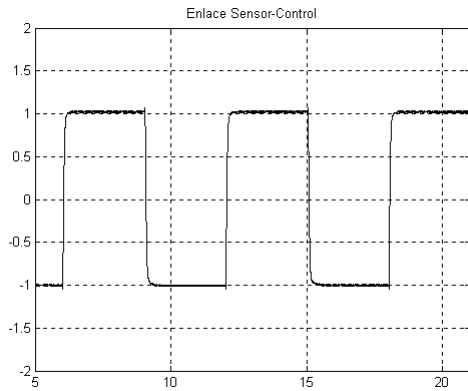

Figure 12 .- Dual-Rate with access delay

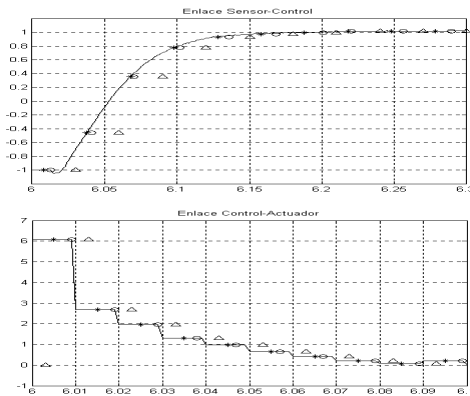

Figure 13 .- Different rate signals

be 30 msec, leading to a dual-rate controller with multiplicity $N=3$. The transfer function of the controller, assuming a *repeat* operator between them, is the following ones:

$$G_{RL}(z) = \frac{z^4 - 1.76z^3 + 1.024z^2 - 0.2366z}{z^4 - 2.171z^3 + 1.333z^2 - 0.146z - 0.01691}$$

$$G_{RR}(z) = \frac{3.045z^4 - 9.614z^3 + 11.12z^2 - 5.558z + 1.012}{z^4 - 2.597z^3 + 2.312z^2 - 0.7514z + 0.03817}$$

This dual-rate controller has been modified with a Smith predictor compensating $30-2.5+10+7.5=45$ msec. An additional delay of 5 msec is applied to every action. The results in these conditions are shown in figure 12. As the delay has become constant, the random irregularities have disappeared. Theoretically, the system behaviour should be the ideal one (figure 3). Again, differences are due to inaccuracy in the plant model. Details in figure 13 show that no information is lost or reused (i.e. there are no vacant samplings or message rejections).

7. CONCLUSIONS

It is difficult to test any kind of solutions over a real ICCS, especially if they affect the loop stability and depend of the random access delays. To get a significant delay, there must be a great number of devices sharing the communication link. The real-time implementation developed is a good test bench to imitate the behaviour of an ICCS. The most

important characteristics are related to time parameters, so a good accuracy in time management is necessary. Only real-time implementations offer a precise enough control of the time instants in which ICCS events take place. RTWT is a good and easy-to-use tool to implement real-time control structures and hardware-on-the loop simulations.

Theoretical assumptions about the application of multirate technique have been checked over a real plant. The influence of arbitrarily large random access delays on the system stability has been proved. Also, the presence of vacant samplings and message rejections has been observed in the real systems, when random access delays and lack of synchronization. Both problems have been solved with multirate techniques. Discrete signals with different sampling periods are used in both directions of communication. Low frequency signal is used in feedback signal to allow a high enough frequency in control signal application. As two different frequencies are present in the same loop, a dual-rate controller must be used. System behaviour recovers its stability when dual-rate controller is employed.

REFERENCES

- Albertos, P., Salt, J. and Tornero, J. (1996). Dual-rate adaptive control. *Automatica*. **Vol. 32-7**, 1027-1030
- Casanova, V., Salt, J. (1999). First approximation on the design of a multirate control loop for an ICCS. *Proceedings of the 15th ISPE/IEE International Conference on CAD/CAM, Robotics and Factories of the Future*. Aguas de Lindoa (Brazil).
- Casanova, V., Salt, J. (2000). Multirate control for an ICCS environment. Part I : the random access delays. *Proceedings of the 2nd IFAC Workshop on Linear Time Delay Systems*. Ancona (Italy).
- Coffey, T.C. , Williams, I.J. (1966) Stability analysis of multiloop, multirate sampled systems. *AIAA Journal*. **Vol. 4, No. 12**, 2178-2190.
- Halevi, Y., Ray A. (1988). Integrated communication and control systems : Part I - Analysis. *Journal of Dynamic Systems, Measurement and Control*. **Vol. 110**, 367-373.
- Salt, J , Albertos, P. (2000). Multirate controllers design by rate decomposition. *Proceedings of the 39th Conference on Decision and Control*. Sidney (Australia).
- Salt, J , Casanova, V. (2000). Multirate control for an ICCS environment. Part II : the time skew problem. *Proceedings of the 2nd IFAC Workshop on Linear Time Delay Systems*. Ancona (Italy).
- Smith, O. (1958). *Feedback control system*. McGraw-Hill.

Acknowledgements

This work has been supported by the Plan Nacional de I+D, Comisión Interministerial de Ciencia y Tecnología (CICYT), program TAP98-0252-C02-02.