

INDUSTRIAL CONTROL SOFTWARE TEACHING AT THE DEPARTMENT OF ACS FEI STU

J. Flochová*, D. Mudrončík†

*Department of Automatic Control Systems, Faculty of Electrical Engineering and Information Technology and †Faculty of Materials Science and Technology, Slovak University of Technology, Slovak republic, ++421-2-602091667, fax.++421-2-65429734
flochova@kasr.elf.stuba.sk, mudronci@mf.stuba.sk

Keywords: Industrial control, Control education, Controller, IT technology, SCADA/HMI

Abstract

New developments in computer networks and communications provide new possibilities also for control purposes. Control systems for highly complex plants are themselves very complex and heterogeneous. A new software and hardware infrastructure is needed that exploits these new emerging software technologies. An essential activity to be pursued is that of education and of including new technologies in control education. The aim of this paper is to describe some of our activities and experiences in teaching of information techniques and industrial technologies included in open control platforms of control systems.

1. Introduction

Today's world is changing rapidly; the global market generates a need of global technical support. Information technology (IT) and telecommunication technology enable remote access to equipments and provide a large number of opportunities for enhancing the speed and quality of the support process [9]. Rapid developments that are taking place in the areas of computer science and communications influence the field of computer control. Systems are subjected to many constraints concerning energy consumption, safety and reliability conditions, environment protection, next to ever-increasing demands on economical production and trading-results. Notions of "control" are expanding from the traditional loop-control concept to include such others functionalities as supervision, coordination and planning, situation awareness, diagnostics, and optimisation. Complex dynamic distributed systems are demanding new capabilities that traditional control technology is not offering. Nowadays the field is characterized by a gap between academic research, education, user needs and industrial practice. One needs to work closer with various groups of researchers, teachers, applications engineers, and to take into account the real needs of applications in developing of appropriate solutions.

An essential activity to be pursued is that of education and of including new technologies in control education.

The aim of this paper is to describe some of our activities and experiences in teaching industrial information system design and IT included in open control platforms of distributed control systems. The paper is organized as follows: in the second chapter we briefly describe the PLC and the IT laboratories, in the third chapter we introduce the concept of our courses, the fourth chapter describes some of our activities and experiences in teaching of information techniques and industrial technologies. The chapter contains several examples of student projects.

2. The PLC and IT laboratories at the Department of ACS FEI STU

The five and half years' study at our faculty is divided into three periods. The basic stage (2 years) gives students theoretical knowledge (Mathematics, Physics and Control Theory). The second period (2 years) that ends with the Bachelor's degree provides a basis for a specific discipline. In this period, various laboratories three of them being the Industrial control software laboratory, the AB Laboratory and the Industrial information system laboratory support the courses. In the last study period at our Department which ends with obtaining the title of Engineer (Master's degree), students submit their diploma theses and take the final (state) examination in three main subjects.

The Industrial software laboratory was established at our Department six years ago. The present equipment covers 5 Honeywell's digital controllers UDC3300 (fig. 1 a-c), I/A Series Softpack and an older Yokogawa control system.

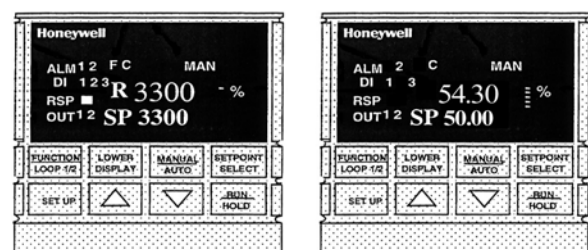

Figure 1a: Panel of UDC3300

Universal digital controllers UDC3300 [4] are microprocessor-based dual-loop devices dedicated for the control of temperature, pressure, flow and other variables. They are easy to use and offer a wide range of features including Accutune II, fuzzy logic and communications.



Figures 1b-c Honeywell UDC3300 controllers that have been used in Bachelor education.

A universal digital virtual controller is being designed (a master thesis). The designed virtual controller uses equations in [1,7] and covers the following functions:

- INPUT #1 and INPUT #2 acquisition, and conversion into engineering units range
- First-order filtering
- High and low absolute alarming of inputs, process values, deviations and outputs
- ON/OFF, PIDA, PIDB, PD+MR control algorithms
- Auto/Manual operation
- Function SPSEL (Setpoint select), Action (direct/reverse action of the controller)
- Setpoint, output and output rate limits setting.

The Allen Bradley Laboratory was established six years ago. It was possible due to the Global Development Program of Rockwell automation, inc. and due to the help and support of the Allen Bradley product authorized distributor in the Slovak Republic Spel-Procont. At the beginning, the AB Laboratory was equipped with 3 racks of programmable logic controllers SLC5/01 and the software package APS. Later, the system was extended with racks containing the SLC5/02, 5/04, 5/05 processors, two PLC 5 processors, I/O and Flex I/O modules and four Micrologix systems. The present laboratory equipment covers PCs Pentium, Windows NT/2000 OS, six SLC500 systems, four Micrologix systems, two PLC 5 processors, PanelView Operator Terminals, corresponding communication drivers, control (RSLogix), tuning (RSTune), and SCADA/HMI software (RS View32), RSSql and real system models. There are also

workplaces for elaborating of projects and diploma theses. The DH485, DH+, ControlNet, DeviceNet and Ethernet networks have been built in the laboratory and connect all Allen Bradley SLC, PLC and Micrologix nodes. Some hardware and software models of real plants [2,3,7] have been designed in the laboratory. An Ethernet link connects the AB laboratory and the laboratory for *Industrial information systems design and information technology (IT laboratory)*.

The equipment of IT laboratory consists of Windows 2000 OS, MSOffice2000, Visual Studio, Microsoft SQLServer, Sybase PowerDesigner, and CAD tools.

3. Courses

Students coming to the laboratories are already familiar with control systems hardware, plant equipment, operating systems, real time programming and basic principles of the real-time control. The laboratories have been used for teaching of following subjects: Control System Software in the 5th semester (obligatory course, 90-100 students per year), Control System Design, Data Processing in Control Systems, and Control of Discrete Event Dynamical Systems (in the 6th, 7th, 9th semester; 30-70 Students in each course per year and per subject). The courses cover the following topics: software of industrial controllers and PLCs, PLC programming techniques, industrial standards IEC1131-3, STN ISO 3511-1-4, SCADA/HMI design. IT laboratory has been used for teaching CADs and their use in Control systems design and the concepts of relational database management systems (RDBS), real-time DBS and industrial transaction techniques.

The exercises are built on the present laboratories equipments and on the present models. The courses taught there have been subscribed by 65-70% of control engineering students in the last three years.

4. Industrial transaction managers

4.1 RSSql – an Industrial transaction platform.

RSSql[™] (RSSql [6]) is a WindowsNT/2000 based industrial transactions processing system for sharing manufacturing data between enterprise systems and control systems. The tool provides a bi-directional link between control systems and enterprise database systems. The architecture consists of four primary components: a graphical interface (GUI) and three NT/2000 services (Transaction Manager, Control Connection, and Enterprise connection). The Transaction Manager executes transactions, controlling, manipulation, and storage of data. The Control Connections are the interfaces to the process control systems; the Enterprise Connections provide links to the relational database management systems. On the control side, RS Sql can connect to RSLinx, RSView32 or RSView Studio or any AdvancedDDE or OPC server. On the enterprise side, RSSql can connect to any ODBC compliant-databases including Microsoft SQL Server, Access, Sybase, Informix and others or to Oracle via their direct callable interface (OCI). The services connect to each other using TCP/IP sockets. This provides the ability to operate as a single system even when

the components are distributed over multiple computers on a network. RSSql supports bi-directional transactions in one of two ways and can be configured to execute a transaction at time-base events or at regular intervals. The control system can also control transaction execution. RSSql provides the ability to trigger a transaction when a control point changes, when it goes high (or low) only, or it can be configured to run at defined intervals while a control points is high. As final check on a transaction prior to going to a database, RSSql provides the ability to analyse several criteria prior to completing the transaction, commits the data, and performs several optional commit procedures. The software can manipulate data prior to passing it to a table or a stored procedure (aggregations of multiple points – Avg(), Min(),...Diff()), provides full complement of arithmetic, bitwise, logical operators and filters, and includes several Wizards to easy system setup and configuration. The tool has many safe guards in place to ensure system and database integrity, its services have the ability to send e-mail notification of failures including lost connections and failed transactions.

The following figures 2. -4. represent a collection of student projects. Any group of students elaborate two projects in the areas of classical RDBS, SCADA real-time databases, RSSQL, RDBS process archives and WEB real-time monitoring of a plant model.

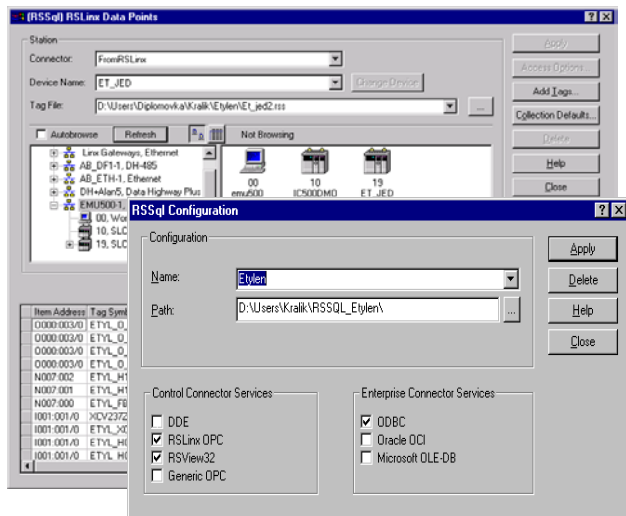

Figure 2: A RSSQL configuration.

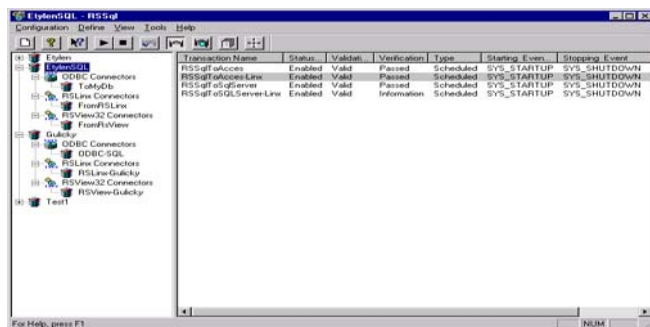

Figure 3: Industrial transactions monitoring. An RSSql Configuration Report follows (shortened):

Report generated on Mon Dec 03 12:30:53.310 2001
Using RSSql Version 2.10.02, Build 2.326

File Messages

Type(s) of message conditions logged:

- Fatal errors
- Severe errors
- Warnings
- Informational messages

The files will be stored in 'D:\Users\Kralik\RSEtylenSQL\' and will contain no more than 10000 messages and be smaller than 1000000 bytes
SMTP E-mail Messages
No errors will be logged

The following services have been configured:

Transaction Manager will run on the host named 'ALAN1', on port 400 using username 'ALAN1\kralik', password '*****'
RSView32 Connector 'FromRsView' (instance 0) will run on the host named 'ALAN1' using username 'ALAN1\kralik', password '*****'
ODBC Connector 'ToMyDb' (instance 1) will run on the host named 'ALAN1' using username 'ALAN1\kralik', password '*****'
Data Base Tables Options:
use table owner when accessing data base tables
Performance Options:
maximum number of real time threads is set to 1
SQL buffer size is set to 4 kilobytes
Cached Transaction Files Options:
cached transaction files will be stored in 'D:\Users\Kralik\RSEtylenSQL\' with a base name of 'ToMyDb'
cached transaction files will be processed when 10 transactions have been logged or 30 second(s) have passed since the last log file has been processed
RSLinx OPC Connector 'FromRSLinx' (instance 2) will run on the host named 'ALAN1' using username 'ALAN1\kralik', password '*****'

The following transactions have been configured:

Transaction 'RSSqlToAccess' (id 2) is enabled, valid, and no verification messages exist defined as:
Solicited and scheduled to run every 1 minute(s) from starting event 'SYS_STARTUP' until stopping event 'SYS_SHUTDOWN' Times out after 1 minute(s) and it always stores its values

Uses the real time thread option to store the transaction Data will be stored using Connector 'ToMyDb' via Data Object 'ToAccess':

using system DSN 'RSSql_Acces', user "", password '*****' new records will be created in table 'Table3'

The following bindings have been configured:

Column 'Txt'
type is String, size is 50
NULLs are allowed
IS BOUND TO...
Expression "RSView_Etyl"

Column 'FB806C'
Type is Signed Short, size is 2
NULLs are allowed
IS BOUND TO...

DataPoint 'FromRsView.work1.bl85_LRA806' from Connector 'FromRsView' via server 'alan1', device "", access path 'work1' tagfile " scheduled via hot link retrieval timeout of 2 second(s) valid timeout of 0 second(s) substitute specific value of 'NULL'

similar DataPoints definitions follow

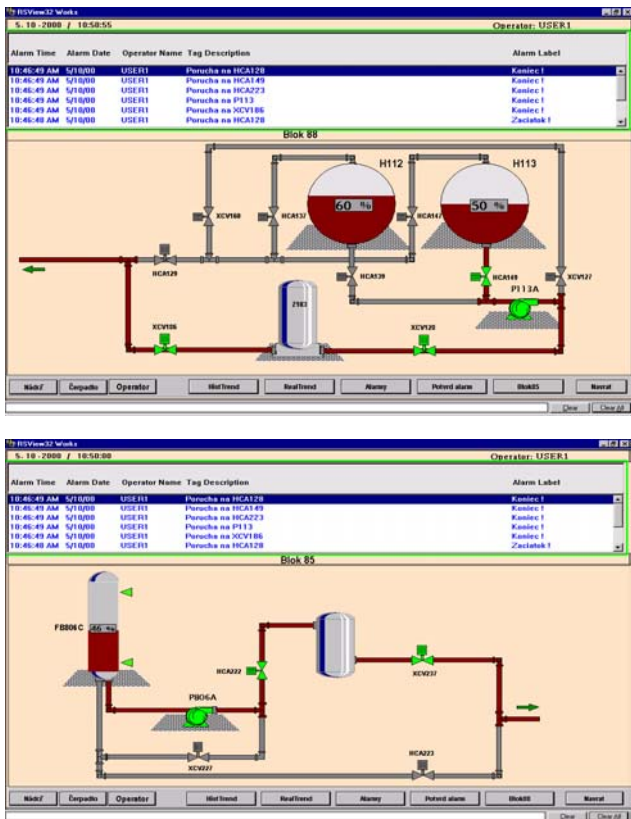

Figure 4: RSView32 SCADA/HMI. A simplified chemical plant (storage tanks of ethylene) used for the RSSql configuration and in a WEB-based monitoring application.

5 SCADA/HMI, ICS and plant models

RSView32 (Rockwell Automation, Inc., figure 5) designed for Microsoft Windows 2000 and NT is an integrated, component-based SCADA/HMI for monitoring and controlling automation machines and processes. RSView32 is both an OPC client and server, provides added flexibility for peer-to-peer networking and the ability to implement a HMI that easily interfaces control products from multiple vendors.

The tool has been used in teaching SCADA/HMI design principles (project configuration, tag database, project-level and system-level security features configuration, graphic displays and trends design, data, alarms and events logging and monitoring,).

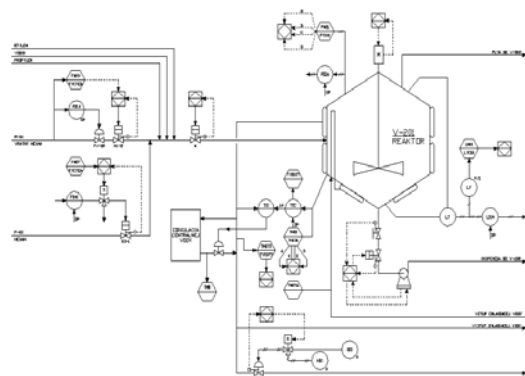
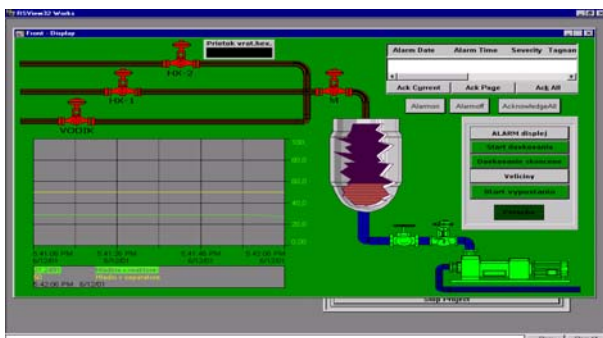

Figure 5: RSView32. An operator interface, the simplified plant in the background designed following a real technology.

Integrated control system I/A Series Softpack (Foxboro Invensys Systems, Inc, fig. 6 a-c) for Windows NT has a powerful configuration of control structures and strategies. The basic element for implementing any of the various control tasks in the system is the block. The integrated control configurator of Softpack contains various types of blocks: Input/Output, Control, Selection, Ramping, Dynamic compensation, Computation, Logic, Conversion etc. In continuous control, a block is a member of a set of predefined algorithms organized in groups called compounds - logical selection of blocks (typically three to six) that perform a specific control task. Any block in any compound can be connected to any other block in any other compound. E.g. a cascade control strategy can be built by selecting two Analog Input blocks, two Proportional/Integral/Derivative (PID) control blocks and one Analog Output block.

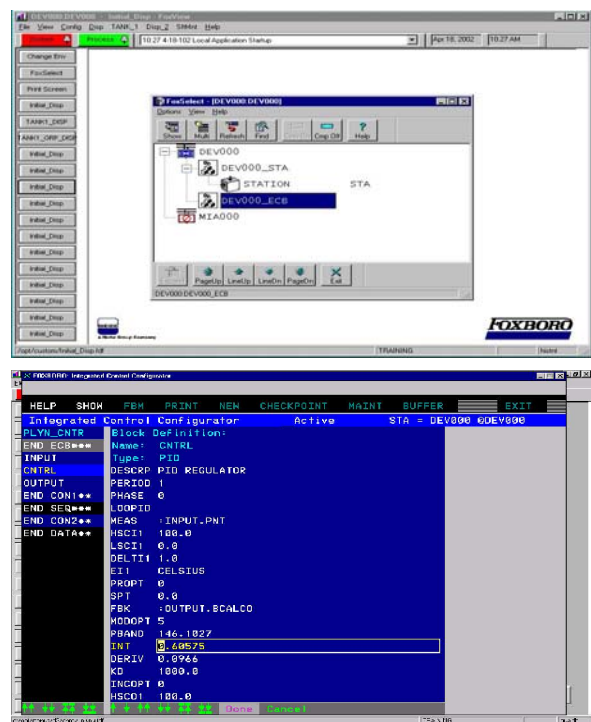

Figure 6ab: I/A Series Softpack , Integrated control configurator.

Configuration tools of such systems could be used like process simulators; the dynamics of a process plant may be modelled with help of pre-programmed control blocks. Several possibilities, and our experiences are briefly described in the following paragraphs.

RSView32 enables simultaneous work of a model and a SCADA/HMI application. A simple RSView32 model may consist of a collection of derived tags and Visual Basic modules attached to the objects. The tool has a built-in programming language Visual Basic® for Applications (VBA) allowing various ways to customize RSView32 projects. The tool can interact with Microsoft Office, and other Rockwell Software products, and other third-party software. The RSView32 architecture allows extending RSView32 with additional functionality.

Integrated control configurator of Softpack allows an effective process simulation. Several plant models controlled by cascade loops have been developed in the laboratories by our students. The dynamics of controlled plants has been modelled by parallel and serial composition of Dead Time and Lead-Lag blocks. The designed software models are robust, they don't need expensive and failure prone physical equipment

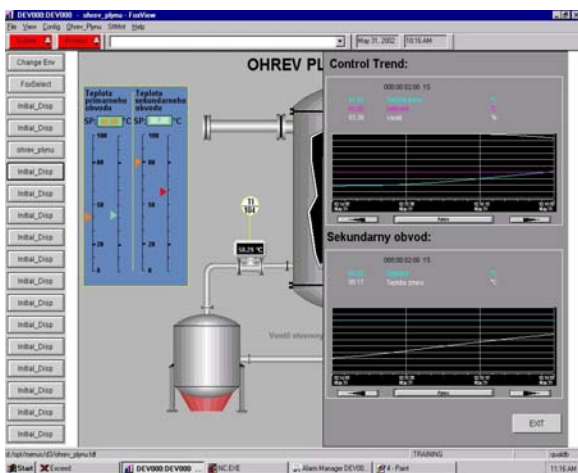

Figure 6c: Softpack - a bachelor thesis.

5. Conclusions

New developments in computer networks and communications, combined with new ways on information processing provide new possibilities for control purposes. Control systems for highly complex systems (such as processing plants, manufacturing processes, aerospace vehicles, traffics and power plants) are themselves very complex. A new software infrastructure for control systems is needed that exploits these new emerging software technologies. In complicated systems there will be more emphasis on real-time computer control and real-time communication. An open control platform (OCP) for complex systems, that coordinates distributed interaction among diverse components and supports dynamic reconfiguration and customisation in real-time, and the issues of new IT and communications technologies will be

of major importance in the areas of control engineering and of new control engineers teaching. In the future the students will need a better background of newest IT technologies among others the background in the field of database systems, industrial transaction technologies of real-time databases and Internet based monitoring and/or management. It will help them to identify potential problem areas, analyse the failures in control systems, minimize errors, improve control efficiency and other key performance indicators, get the data to optimise and improve the manufacturing effectiveness.

The industrial tools and their simulators improve student's knowledge of physics, mathematics and other skills, which have been taught by the department staff, they increase their imagination, creativity, learn them diagnose failures in their code and deal with practical real world problems.

Acknowledgement

This work was supported in part by Slovak Vega grant VG-0155-Koz-Sk – Intelligent method for modelling and control and by the grant APVT 51-011602.

References

- [1] Åström, K., Hagglund, T. "PID Controllers: Theory, Design and Tuning", 2nd edition. Instrument Society of America, USA, (1995).
- [2] Flochová, J. and Galbavý, M. (2003) "Database technology and industrial transaction techniques in control education", *Preprints of the IFAC Symposium on Advances in control education*, Oulu, Finland, (2003).
- [3] Hruz, B., Ondráš, J. and Flochová, J. "Discrete event systems-an approach to education", *Proceeding of the 4th symposium on Advances in control education*, Istanbul, Turkey, pp.283-288, (1997).
- [4] <http://content.honeywell.com/imc/pi/controllers/>
- [5] "I/A Series Softpack Release note and installation guide", The Foxboro company, U.S.A., (1998)
- [6] Rockwell software products, (2003). <http://www.software.rockwell.com/index.cfm>
- [7] L. Smejkal, T. Vyhliđal, T.: "Modeling, simulation and PLC". *Automatizace 8/2000*, pp. 526-532.
- [8] "UDC3300 Universal Digital Controller", Product Manual 51-52-25-55. Honeywell, U.S.A. (1999).
- [9] Vebruggen, H.B. et al. "IFAC 2002 Milestone report on computer control", *Preprints of 15th Triennial World Congress*, Barcelona, Spain, July, pp.233-241, (2002).