

OPERATION OF A BATCH DISTILLATION COLUMN WITH A MIDDLE VESSEL: EXPERIMENTAL RESULTS FOR THE SEPARATION OF ZEOTROPIC AND AZEOTROPIC MIXTURES

M. Warter*, D. Demicoli** and J. Stichlmair**

* Linde AG, Linde Engineering, Dr.-Carl-von-Linde-Str. 6-14, D-82049 Höllriegelskreuth, email: Michael.Warter@Linde-LE.com, Germany

** Lehrstuhl für Fluidverfahrens-technik, TU München, Boltzmannstr. 15, D-85748 Garching, Germany, email: Daniel.Demicoli@fvt.mw.tum.de and Johann.Stichlmair@fvt.mw.tum.de

ABSTRACT

Batch distillation in a column with a middle vessel can avoid many of the disadvantages associated with the regular batch distillation processes. In this paper we present an experimental investigation of the separation of a zeotropic ternary mixture via total reflux operation and of the separation of an azeotropic binary mixture via batchwise extractive distillation. Moreover, the results obtained for the two processes are compared with the experimental results of the corresponding regular batch distillation processes carried out in the same pilot plant.

Keywords: Batch Distillation; Middle Vessel Column; Experimental Investigation; Azeotropic Mixtures; Batch Extractive Distillation; Total Reflux Operation

INTRODUCTION

Batch distillation is a very efficient unit operation which allows the fractionation of a multicomponent mixture into its pure constituents in a single column. Due to its flexibility and low capital costs, batch distillation is becoming increasingly important in the fine chemicals and pharmaceutical industries. However, the regular batch distillation processes have some disadvantages, such as:

- High energy demands
- High temperatures in the feed vessel. This, combined to the high residence times, may lead to the decomposition of substances.

Regular batch distillation is the most common form among the possible batch distillation processes (*Fig. 1*). In this type of process, the feed is charged to the still at the bottom of the column and the products are withdrawn from the top. In an inverted

batch distillation process the feed vessel is connected with the top of a stripping column and the products are withdrawn from the bottom (Fig. 1b). The third configuration shown in figure 1 is the so-called batch distillation with a middle vessel. It is a combination of a regular and an inverted batch distillation and was originally proposed by Robinson and Gilliland [1]. The column is divided into a rectifying and a stripping section by the feed vessel which is connected to the middle of the column. With this type of process it is possible to obtain simultaneously light and heavy boiling fractions from the top and the bottom of the column respectively. An intermediate boiling fraction accumulates in the middle vessel. Batch distillation configurations with more than one intermediate vessel are called multi-vessel batch distillation columns (Fig. 1d).

Own theoretical investigations show the advantages of batch distillation with a middle vessel. It can lead to lower temperatures in the feed vessel, to energy and entrainer savings and to an easier handling of the liquid fractions involved in the process [2]. While many publications studied this kind of process in a theoretical way [3-16], only a few examined the practical side [17-20]. These experimental investigations focused on the separation of zeotropic systems and mainly on the separation into only two fractions. The objective of our presentation is to show own experimental results obtained with a modified regular batch distillation column for the separation of zeotropic mixtures into three fractions and for the separation of azeotropic mixtures. Moreover, we experimentally compare the batch distillation processes with a middle vessel with the corresponding regular batch distillation processes and show the practical advantages of the former.

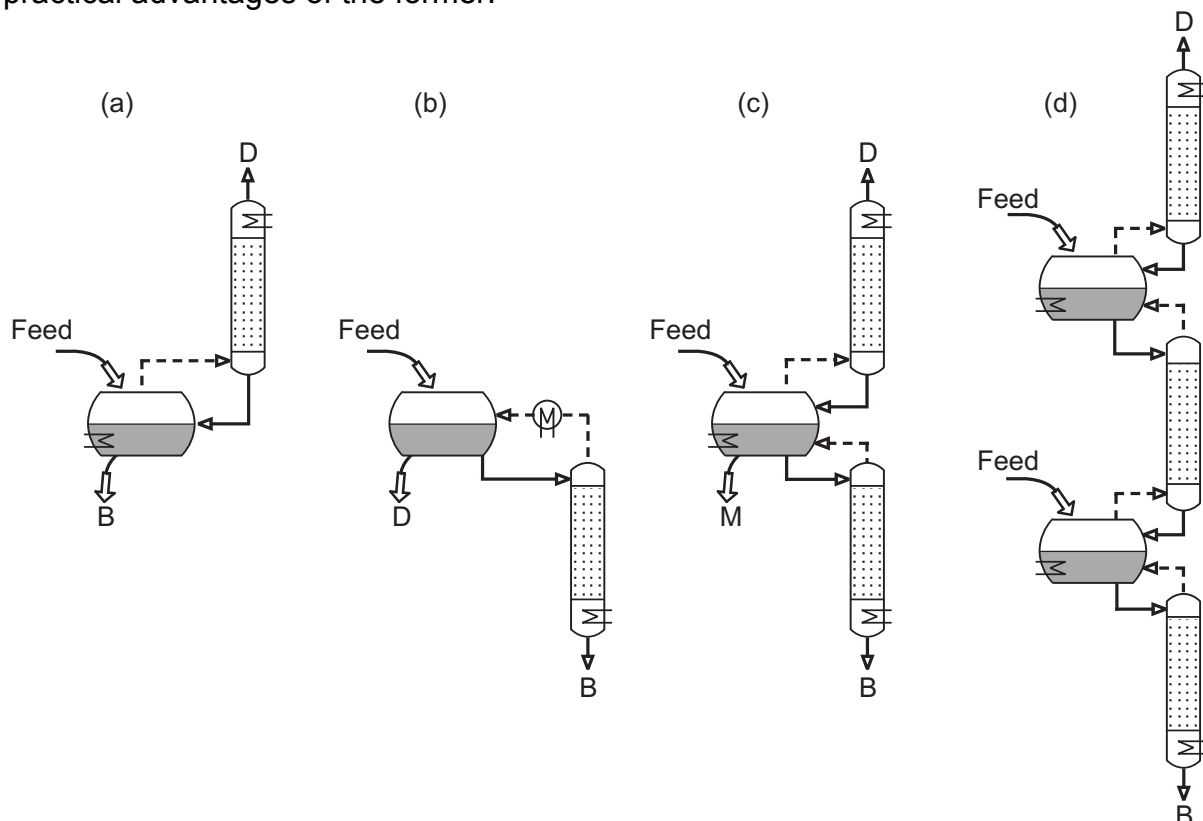

Fig. 1: Different types of batch distillation processes – (a) regular and (b) inverted batch distillation, (c) batch distillation with a middle vessel and (d) multi-vessel batch distillation.

THE PILOT PLANT

Description of the Pilot Plant

The pilot plant is shown in *figure 2*. The column is 3 meters high, has an internal diameter of 50 mm and is divided in five sections *K1-K5* which are thermally insulated by a mirrored vacuum double glass wall. The five sections are located vertically above the reboiler vessel *B4*. Sections *K2*, *K3* and *K5* are randomly packed with meshed wire rings (3 mm diameter) while sections *K1* and *K4* have no internals. Five 10 litre vessels (*B1-B3* and *B5*, *B6*), used for the storage of liquids, are connected to the column. The temperature of vessel *B6* can be controlled by the thermostat *T1*.

At the top of the column, the rising vapour is condensed in the heat exchanger *W1* and the resulting condensate is sent to the reflux valve *V1*. Depending on the position of the reflux valve, the condensate can either flow back to the top column section *K1* or flow through a distillate sub-cooler *W2* to the distillate vessel *B1*.

Section *K4*, placed between sections *K3* and *K5*, connects the thermally insulated middle vessel *B3* to the column. This section acts as a “chimney tray”, i.e. the rising vapour passes unhindered while the down flowing liquid is withdrawn to valve *V2*. Depending on the position of the valve *V2*, the column can be operated either as conventional regular batch column (the liquid is directly fed back to the column) or as middle vessel column (the withdrawal is sent to the middle vessel *B3*). The liquid from the middle vessel can either be pumped back by the pump *P1* to the column or it flows through the valve *V13* by hydrostatic height.

The liquid reaching the reboiler vessel *B4*, can either be accumulated in the vessel and is therefore vaporised in the electrical heat exchanger *W4*, or is withdrawn via the bottom product cooler *W3* to the bottom product vessel *B5*. The pump *P2* allows to pump liquid from the bottom vessel to the top of the column.

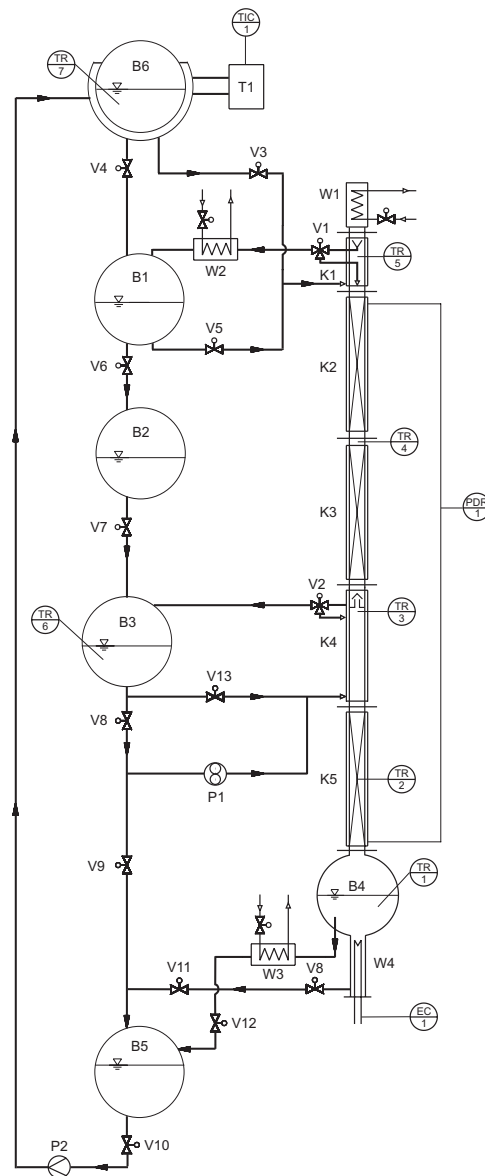

Figure 2: The pilot plant.

Various thermo-resistance elements are distributed along the column, in the middle vessel and in the reboiler (*TR1-TR7*). All electrical input/output signals to pumps, valves, reboiler heater and the measurement elements are interfaced to a computer using LABVIEW[®] from National Instruments[®] [21] for process control, data

visualisation and storage. Samples of liquid can be collected through different additional manual valves and are analysed in the lab by gas chromatography.

Planing a New Column

The following summarises some important aspects for planing a new column with a middle vessel.

Number of stages

Theoretical investigations show that the number of stages has the same influence on the energy demand of a separation as in any other distillation process i.e. with increasing number of stages the energy demand decreases [22]. Since batch distillation columns are used for varying feed systems and different separation tasks, the number of stages should be high enough to carry out different separations with a reasonable energy and, therefore, time demand of the process.

Location of the middle vessel

The location of the withdrawal and reflux to and from the middle vessel has a big influence on the energy demand [22]. In the case the location of the withdrawal/reflux is located too high, the number of stages in the upper column section gets smaller. Therefore, the separation carried out in the upper column section is energy consuming and determines the energy demand of the whole separation. Vice versa, for a very low location of the withdrawal/reflux the separation carried out in the lower column sections determines the total energy demand. Therefore, it can be advantageous to have more than one withdrawal/reflux to and from the middle vessel to fit the connection to the actual separation task. Furthermore, more than one connection offers the possibility to operate the column as a multi-vessel batch distillation column, extending the flexibility of the column [23-27].

Heat exchanger in withdrawal and reflux line of the middle vessel

To avoid the decomposition of critical substances, it might be required to keep the temperature of the charge in the middle vessel as low as possible during the process. This can be achieved by exchanging heat between the hot stream leaving the column and the cold reflux line from the middle vessel, in a heat exchanger. In this way the stream leaving the column is cooled down before entering the middle vessel keeping a low temperature in the vessel. The heat removed is used to pre-heat the liquid from the middle vessel before it enters the column [20].

Additional reboiler in the middle vessel

In the case there is no reason to keep the temperature in the middle vessel low, an additional reboiler in the middle vessel leads to one more degree of freedom of the process. This reboiler generates a vapour stream entering the upper column section. The flow rate of this stream can be manipulated to ,steer' the concentration in the middle vessel [22,11].

Modification of the middle vessel column section

There exist different modifications of the column section connected to the withdrawal and reflux line of the middle vessel. In the plant previously described, this column section (*K4*) acts as a chimney tray i.e. the vapour passes by while the liquid is withdrawn. It would also be possible to withdraw the vapour and let the liquid pass by. This modification of the column section can lead, from a thermodynamic point of view, to energy savings in a batchwise extractive distillation [28]. Nevertheless, it will

be more difficult to realise in practice and, therefore, the chimney tray or an equivalent arrangement will be the most common choice.

SEPARATION OF A ZEOTROPIC MIXTURE

Batch distillation with a middle vessel is very convenient to carry out separations into three fractions, because it has a rectifying and an additional stripping section. In own experiments the separation of low and high boiling impurities from an intermediate boiling product was investigated, which is a very common task in practice. The feed consisted of the low boiler ethanol, the intermediate boiler 1-propanol and the high boiler 1-butanol. A total reflux operation with constant hold-up, which is well investigated for a regular and a multi-vessel batch distillation, was chosen to ensure an easy control of the process.

Operation of the column

The feed is distributed between the top ($B1$), the middle ($B3$) and the bottom vessel ($B4$) such that the volume of liquid in each vessel is equal to the corresponding volume of low, intermediate and high boiler contained in the charge.

After starting the reboiler, vapour starts rising through the column. It is condensed at the top heat exchanger $W1$ and it is completely sent, through the reflux valve $V1$, to the top vessel $B1$. The top vessel is operated at constant hold-up during the process with the liquid level H_{B1} . Hence, the amount of liquid fed to the top vessel is equal to the amount refluxed to the column section $K1$.

In the column section $K4$, the liquid flowing down is withdrawn to the middle vessel $B3$. This vessel is also operated at constant hold-up (liquid level H_{B2}). The liquid hold-up here can be manipulated by the varying the height of the overflow pipe $R1$. The liquid is send back to the column section $K4$, flows through the column section $K5$ and enters the reboiler $B4$.

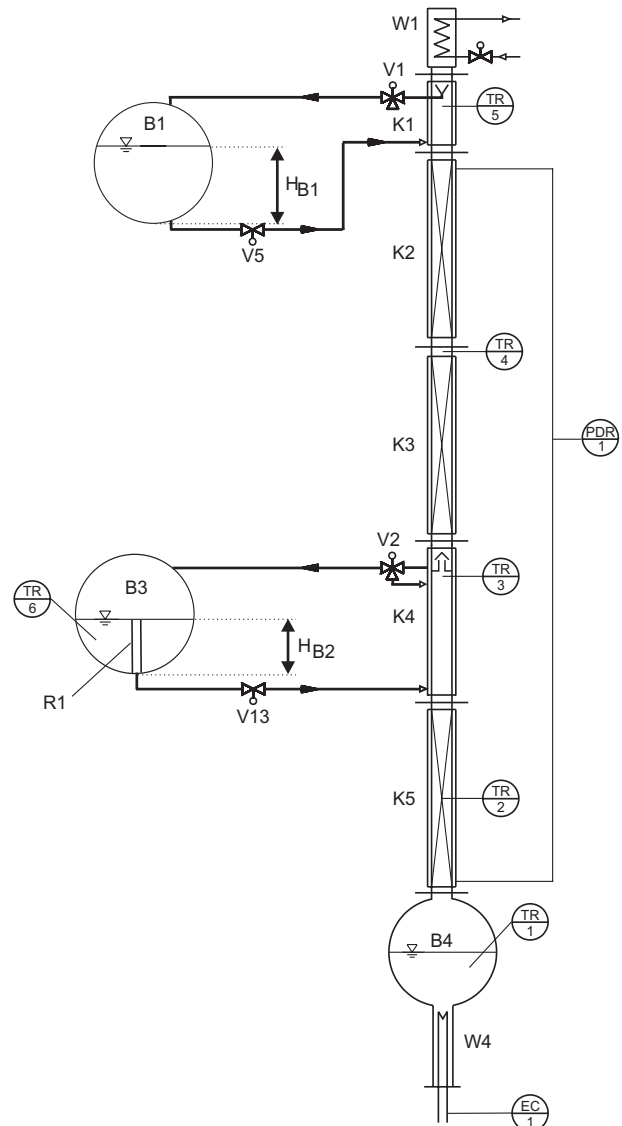

Fig. 3: Total reflux operation.

Concentration Path of the Liquid in the Vessels

Figure 4 shows the liquid concentration in the top vessel, the middle vessel and the reboiler during the process versus the relative distillation time. At the beginning, the concentration in the three vessels equals the feed concentration:

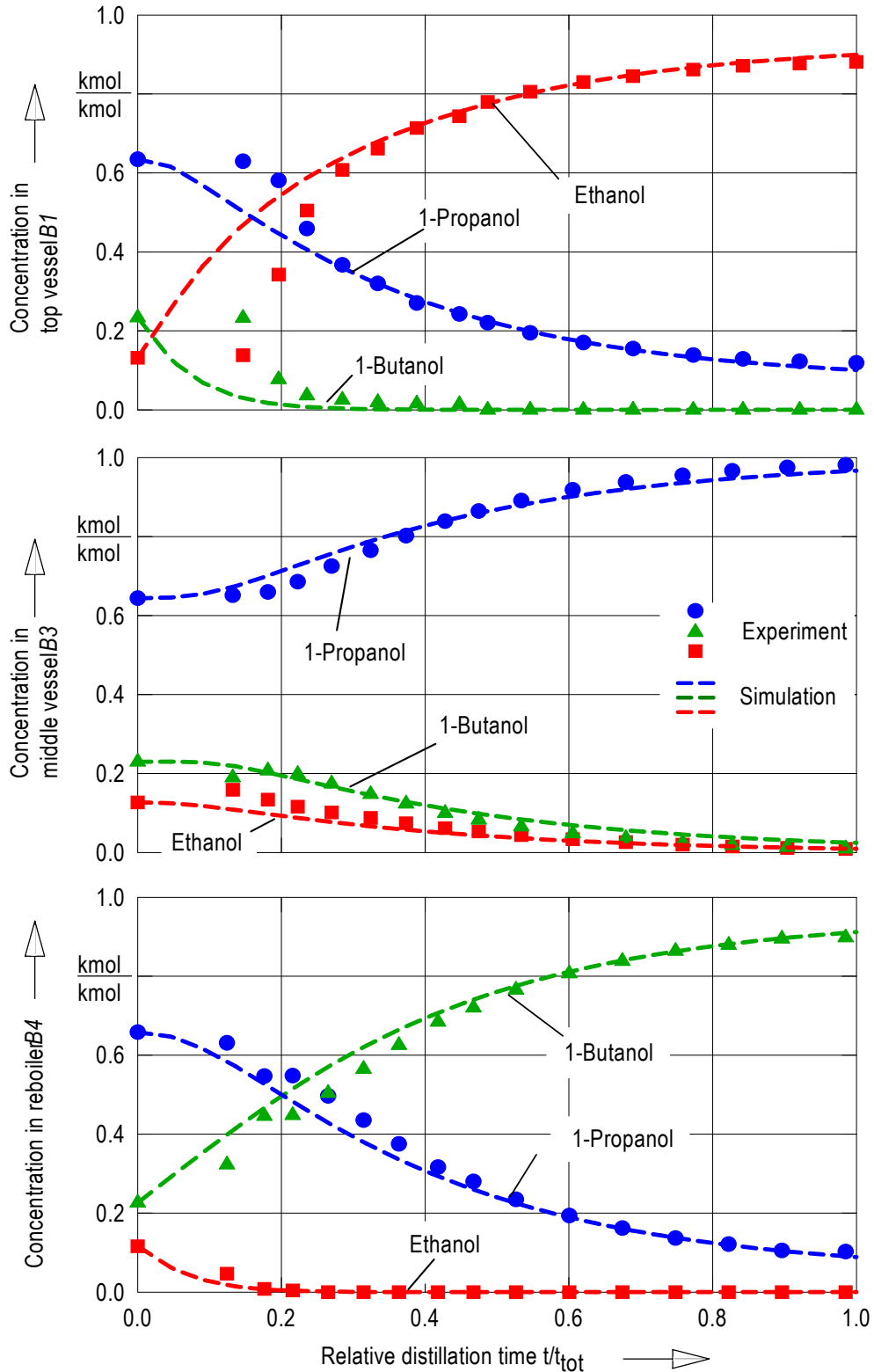

Fig. 4: Concentration in vessels B1, B3 and B4 versus the relative distillation time - experimental and simulation results.

12 mol% ethanol, 65 mol% 1-propanol and 23 mol% 1-butanol. After the start-up, the top vessel depletes in the high and intermediate boilers while it accumulates in the low boiler, ethanol. Vice versa, the reboiler depletes in the low and intermediate boilers while the concentration of the high boiler, 1-butanol, increases. While the low and the high boiling components move to the top and the bottom of the column respectively, the concentration of both components in the middle vessel decreases and that of the intermediate boiler, 1-propanol, increases.

At the end of the process, the product 1-propanol has accumulated in the middle vessel in 98 mol% purity. The low and high boiling impurities can be removed from the top and bottom vessel with concentrations of ethanol and butanol of 88 mol% and 90 mol% respectively.

In addition to the experimental results, *figure 4* shows the results of a computer simulation (dashed lines). The simulation was carried out with Speedup[®] from Aspen Plus[®] [29]. Simulation and experiment show good agreement in most parts even though the simulation is based on numerous assumptions such as constant molar hold-up in the vessels, omission of fluid dynamics, no heat losses over the column and no sub-cooling at the condenser.

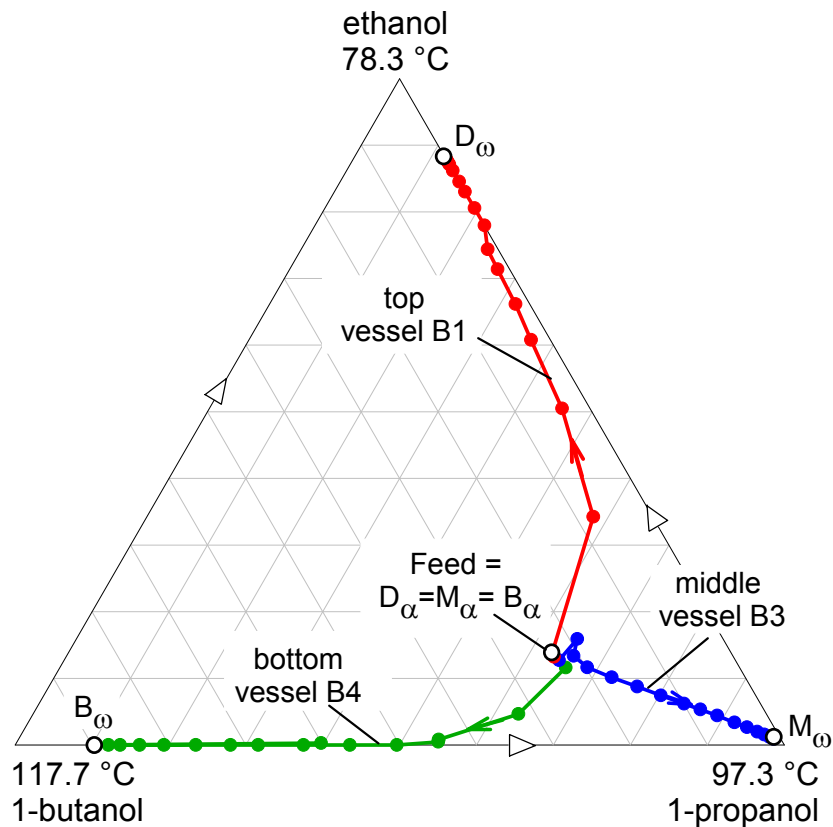

Fig. 5: Concentration paths of the liquids in vessels B1, B3 and B4 shown in a triangle diagram.

Figure 5 shows the concentration paths of the liquids in each vessel in a triangular diagram. It visualises once again what is happening during the process. At the beginning there is the feed concentration in all three vessels ($Feed = D_\alpha, M_\alpha$ and B_α). After the start-up, the concentrations of the liquids in the three vessels move directly to the corners of the triangle which represent the pure components.

Temperatures and Control of the Process

Temperature measurements are taken for the control of the process. *Figure 6* shows the temperature measurements of the elements *TR1* – *TR6* versus the relative distillation time. At the beginning, there is the temperature of 20°C over the column height, in the middle vessel and in the reboiler. After the start-up, the temperature in the reboiler increases (*TR1*). When the liquid in the reboiler reaches the bubble point, vapour starts rising through the column and, therefore, the temperature in the column increases (*TR2* – *TR5*). At the relative distillation time of 0.1 the first vapour is condensed at the top of the column and refluxed. With the initial reflux, the temperature in the top section of the column decreases (*TR5*) because the low boiler accumulates in this section. The concentration of the high boiler in the lower column section increases and with this, the temperature in the reboiler (*TR1*).

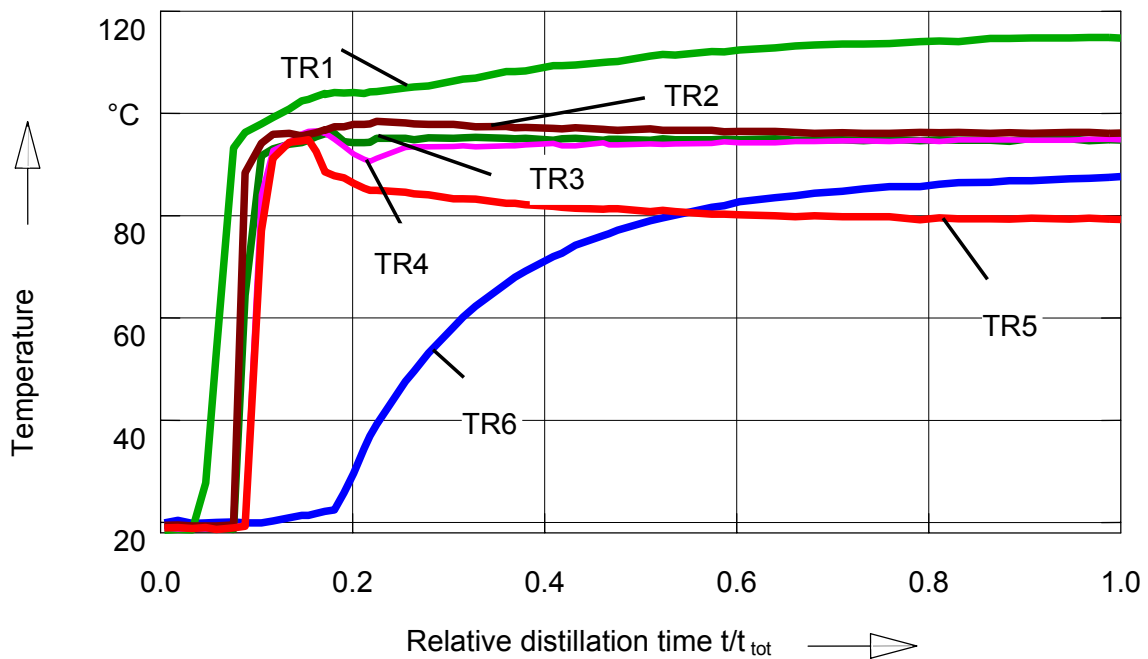

Fig. 6: Temperatures in the column and the middle vessel versus relative distillation time.

The temperature *TR6* in the middle vessel behaves differently from the others. It increases very slowly during the process because the big amount of liquid in the vessel is heated up just by the incoming liquid from the column. At the end of the process the temperature in the middle vessel reaches asymptotically a value slightly below the boiling point temperature of the intermediate boiler.

The process will be stopped when the internal concentration profile over the column height reaches steady-state and there is no separation any more. This can be easily seen by the temperature curves. At the beginning of the process there are big changes in the concentrations and, therefore, there is also a big change in the temperatures over the column height, especially for the top and bottom temperatures *TR1* and *TR5*. At the end of the process, when there is no separation any more and the concentration profile reaches steady-state, the temperatures keep nearly constant over the distillation time and the process is stopped.

Advantages of Batch Distillation with a Middle Vessel over Regular Batch Processes

To investigate the advantages of batch distillation with a middle vessel, the same feed was separated in the pilot plant operated as a conventional regular batch distillation column with constant reflux operation. The separation was not exactly the same because otherwise it would be necessary to fit the reflux ratio exactly to the same recovery. Nevertheless, the experimental results reveal the advantages of batch distillation in the middle vessel column concerning the temperature in the feed vessel, the start-up of the process, the product changeovers, etc.

Temperature in the feed vessel

In the regular batch distillation process the total amount of feed is charged to the still and is heated up to the bubble point (Fig. 7). Therefore, the feed is exposed right from the beginning to high temperatures. This can be harmful for substances which tend to decompose. The temperature in the feed vessel increases continuously during the process until it reaches the bubble point temperature of the high boiler which remains at the end of the process in the still.

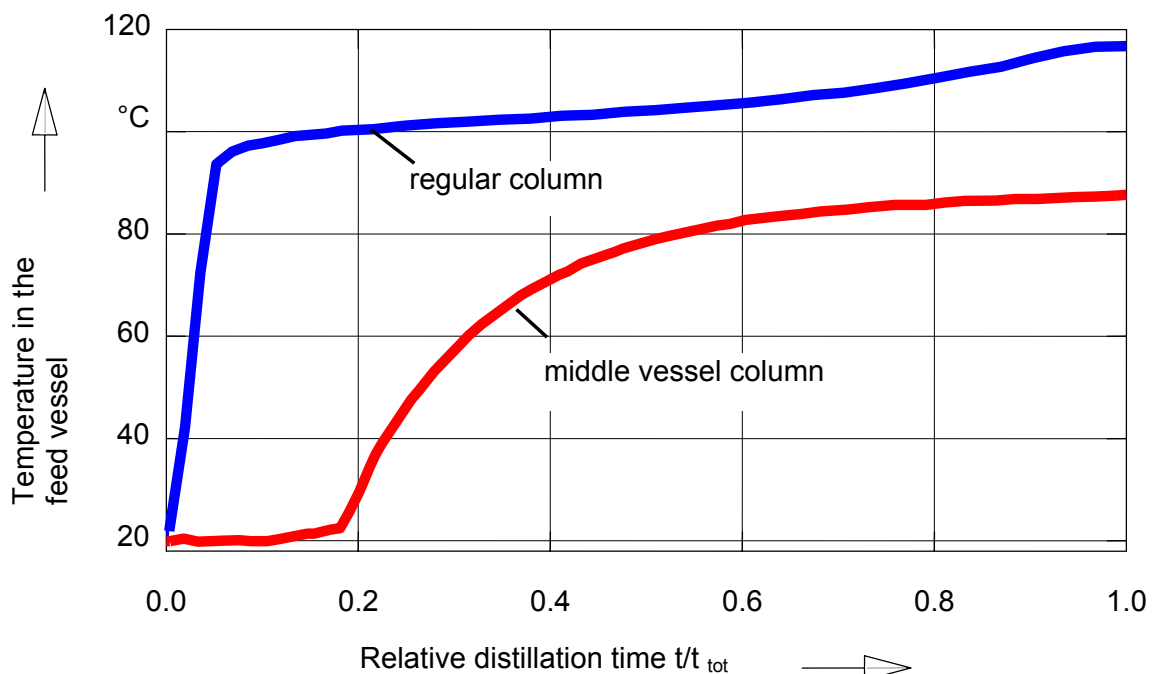

Fig. 7: Experimental comparison of the temperature in the feed vessel of a regular batch distillation process and a batch distillation with a middle vessel.

In a batch distillation with a middle vessel, only the fraction of feed charged to the sump is heated up to the bubble point temperature at the beginning, while the normally big part in the middle vessel is just exposed to ambient temperature. There is also an increase in temperature in the middle vessel over the process time but the slope is lower and the temperature never reaches the boiling point temperature of the high boiler. Hence, by using a batch distillation with a middle vessel the temperature in the feed vessel can be reduced significantly and an intermediate boiling product is saved.

Contact of product with hot surface of reboiler

A disadvantage of the conventional regular batch process is that every component gets in contact with the hot surface of the reboiler [30]. In the regular batch process the product is kept in the reboiler as long as the low boiling impurities are removed from the top of the column. In the operation as a middle vessel column only the amount of product which is in the sump gets in contact with the reboiler surface. In the experimental investigation this was just 35% of the amount in a regular batch process. In separations with higher amounts of intermediate boiling product in the feed, the fraction in the reboiler will even get smaller.

Start-up

The smaller amounts of liquid in the reboiler of a middle vessel column lead to advantages in the start-up of the column. While in a conventional batch distillation process the total amount of feed is heated up to the boiling point at the start-up of the process, it is just a small amount when using a batch distillation with a middle vessel. In the own experimental comparison the duration of the start-up of the process could be reduced by 45%.

SEPARATION OF AN AZEOTROPIC MIXTURE – BATCH EXTRACTIVE DISTILLATION

Extractive distillation is a hybrid process resulting from the combination of absorption and distillation. In this process, a high boiling entrainer, which preferentially absorbs one of the azeotrope-forming components, is continuously fed to the distillation system. This changes the relative volatility of the system (the component that is absorbed in the entrainer becomes less volatile) re-establishing a driving force for the separation. Generally, a regular batch column is used for batch extractive distillation. Batch extractive distillation in a middle vessel column offers many advantages, such as: simultaneous recovery of the entrainer during the process, low temperature in the feed vessel and possible energy savings [28]. Nevertheless, there are just a few theoretical publications [11,15,28,31-33]. No experimental investigation has been published.

In the following paragraphs we will present the experimental procedure and results for a batch extractive distillation in a middle vessel column for the separation of a 50 mol% ethanol-water mixture, using ethylene glycol as entrainer. In order to compare the process to batch extractive distillation in a regular column, the mixture was also separated in the same plant operated as a regular column.

Operation of the Column

The separation was carried out in the pilot plant described in the previous chapters. The modifications made for the batch extractive distillation are shown in *figure 8*.

The feed was charged to the middle vessel *B3*. The entrainer was charged to the vessel *B6*, placed above the column, from where it could be continuously fed to the column section *K1* at a constant flow rate. A water – ethylene glycol mixture was charged to the reboiler vessel *B4* to supply the minimum level necessary for the start-up of the process.

Start-up: the column was heated up as a regular batch column (i.e. with the middle vessel disconnected), at total reflux and without entrainer feeding until a steady temperature profile was established (*step 1a*) [17]. At this point the middle vessel was

connected to the column, i.e. all the liquid flowing from the upper column section ($K3$) was fed to the middle vessel through valve $V2$ and liquid was fed from the middle vessel to the lower column section ($K5$) at a constant flow rate by the volumetric pump $P1$. The vapour passed by unhindered.

During this step, a liquid with azeotropic composition accumulated in the upper column section. The step was terminated when the temperature profile was constant.

Production of most volatile component:

In this step the entrainer (ethylene glycol) was fed near the top of the column and the plant was operated at a constant reflux ratio. The distillate product was collected in vessel $B2$. The flow rate of the liquid from the middle vessel was manipulated to control the temperature in the reboiler. The entrainer was accumulated in the column's sump $B4$. The end of the production step was indicated by a rise in the temperature profile in the upper column section.

Purification of product in middle vessel:
The liquid in the middle vessel was purified, from the residual most volatile component and from the entrainer accumulated in the middle vessel, in a cyclic operation:

Phase a) This was carried out at total reflux and no entrainer feeding. During this phase, the liquid in the middle vessel was purified from the entrainer (separated in the stripping column section $K5$) and from the most volatile component (accumulated in the hold-up of the upper column section).

Phase b) The reflux ratio was set to a finite value. The most volatile component, collected as a distillate off-cut, was recycled to the next batch. The transition between the two phases of the cycle was indicated by a change in the temperature at the top of the column. One cycle was sufficient to purify the product collected in the middle vessel.

During the process, samples were collected at regular time intervals from the distillate withdrawal, from the middle vessel and from the sump. These were subsequently analysed by gas chromatography.

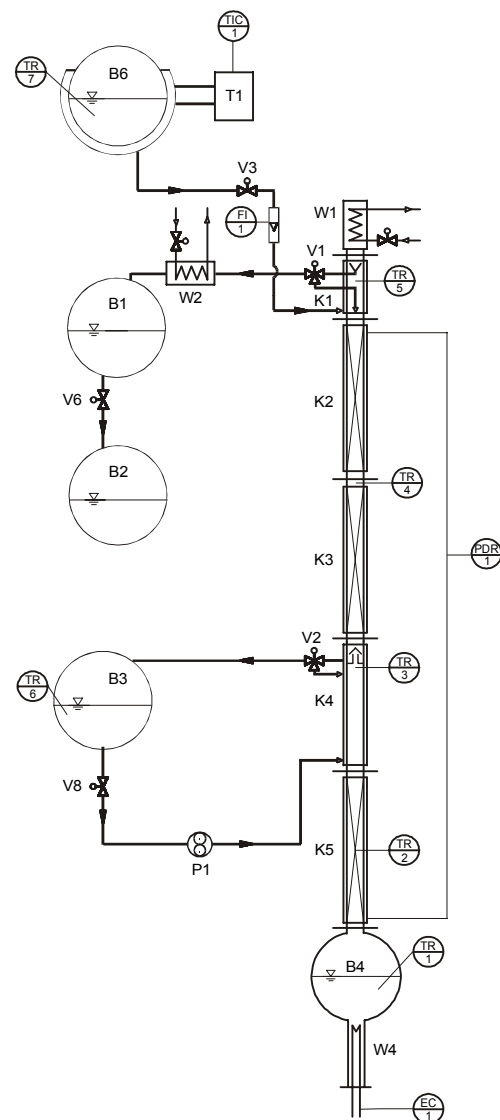

Fig. 8: Flowsheet for the batch extractive distillation process.

The operating sequence is summarised in *table 1*.

Table 1 Operating sequence

	Aim		Reflux	Solvent Feed	Termination Criterion
1a	Start-up	Heating the column.	∞	0	Steady temperature profile
1b		Reaching azeotropic concentration in the upper column section.	∞	0	Steady temperature profile
2	Production of most volatile component.		R	E	Increase of temperature at the top of the upper column section
3a	Purification of product in middle vessel	Accumulation of most volatile component in column.	∞	0	Decrease of temperature at the bottom of the upper column section
3b		Withdrawal of most volatile component as distillate.	R	0	Increase of temperature at the top of the upper column section

Concentration Path of the Liquid in the Vessels

Figure 9 shows the molar concentration paths in the sump, middle vessel and at the condenser.

A 50 mol% ethanol / water mixture was charged to the middle vessel, and a 50 mol% water / ethylene glycol was charged to the sump vessel for the initial column and reboiler hold-up. At the end of the start-up period the concentration in the sump reached almost pure ethylene glycol because most of the water had evaporated. The concentration of ethylene glycol in the sump was maintained high throughout the process.

The middle vessel was then connected to the column. Since the azeotrope had the lowest boiling point it would be the top product of the column. To overcome the azeotrope, the high boiling entrainer was fed close to the top of the column (process step 2). The entrainer absorbed the water from the rising vapour making pure ethanol the top product. Simultaneously, the high boiling entrainer was separated from the water in the lower column section (stripping section). During the second process step the liquid in the middle vessel depleted in ethanol and enriched in water. Only small amounts of entrainer accumulated in the middle vessel.

In the last process step, the remaining parts of ethanol and ethylene glycol were removed from the middle vessel in order to get pure water as product. In this process step the column was operated without entrainer feeding in a cyclic operation. At the end of the operation pure water was in the middle vessel.

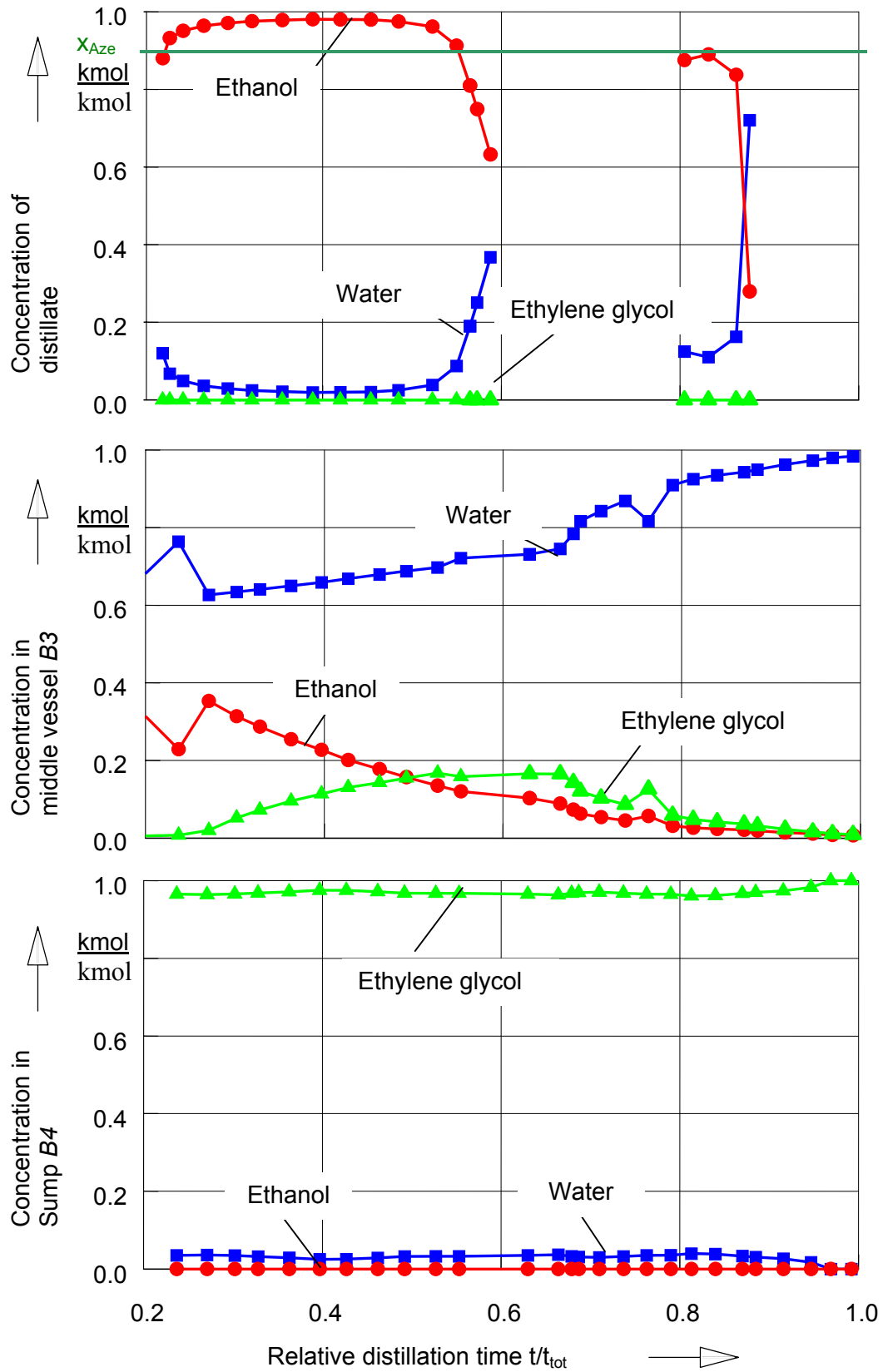

Fig. 9: Concentration path in the distillate, middle and sump vessels.

Temperatures and Control of the Process

The temperature profile in the column is shown in *figure 10*.

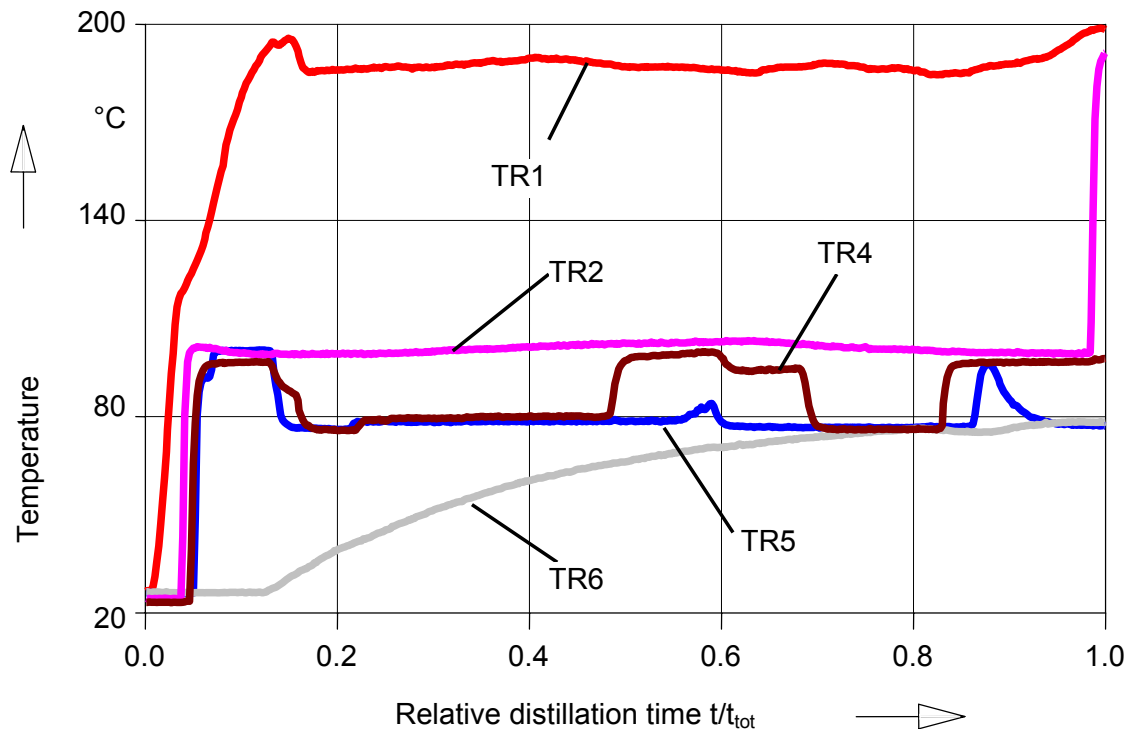

Fig. 10: Temperature profile along the column.

Start-up (relative time 0–0.2):

At the start-up of the process, heat was supplied to the reboiler heating the charge (*TR1*). When the mixture in the reboiler reached the bubble point temperature, vapour started rising through the column and the column was heated (*TR2-TR5*). When the vapour reached the condenser it was condensed and refluxed. The column was then operated at total reflux to establish a constant temperature profile. The middle vessel was connected to the column and the temperature in the upper column section (*TR4* middle and *TR5* condenser) decreased to the boiling point of the azeotropic mixture while the temperature in the middle vessel started increasing (*TR6*). The step was terminated after establishing a steady temperature profile.

Production of most volatile component (relative time 0.2–0.55):

The entrainer was then fed near the top of the column. This was followed by an increase in the temperature at the condenser (*TR5*) because the mixture was now richer in ethanol. Both the temperature in the middle of the upper column section (*TR4*) and at the condenser (*TR5*) were constant at the boiling point of ethanol for a long time during the production step.

The concentration of ethanol in the middle vessel decreased, hence the separation became more difficult and, since the column was operated at a constant reflux ratio, the temperature in middle of the upper column section increased.

The end of the production step was indicated by an increase of temperature *TR5*. At this point the reflux ratio was set to infinity and the feed of entrainer was set to zero.

Purification of product in middle vessel:

During the purification of water (step 3), ethanol was collected in the upper column section. Hence, the temperature at the condenser (*TR5*) decreased to the boiling

point of the azeotropic mixture. This was followed (relative time 0.7) by a drop in temperature in the middle of the upper column section (*TR4*). The decrease in the temperature at the bottom of the upper column section could be used to indicate the termination criterion for the first phase of the purification step.

At this point the column was operated at finite reflux ratio. The temperature profile in the upper column section increased again. Not to waste water (valuable product), the operation was returned to the first phase of the cycle as soon as the temperature at the condenser started increasing (relative time 0.85). One cycle was sufficient for the purification of the product collected in the middle vessel.

Control of flow rate from middle vessel

The liquid flow rate from the middle vessel to the column was manipulated to control the temperature in the reboiler. This control configuration has a slow response (*fig. 11*).

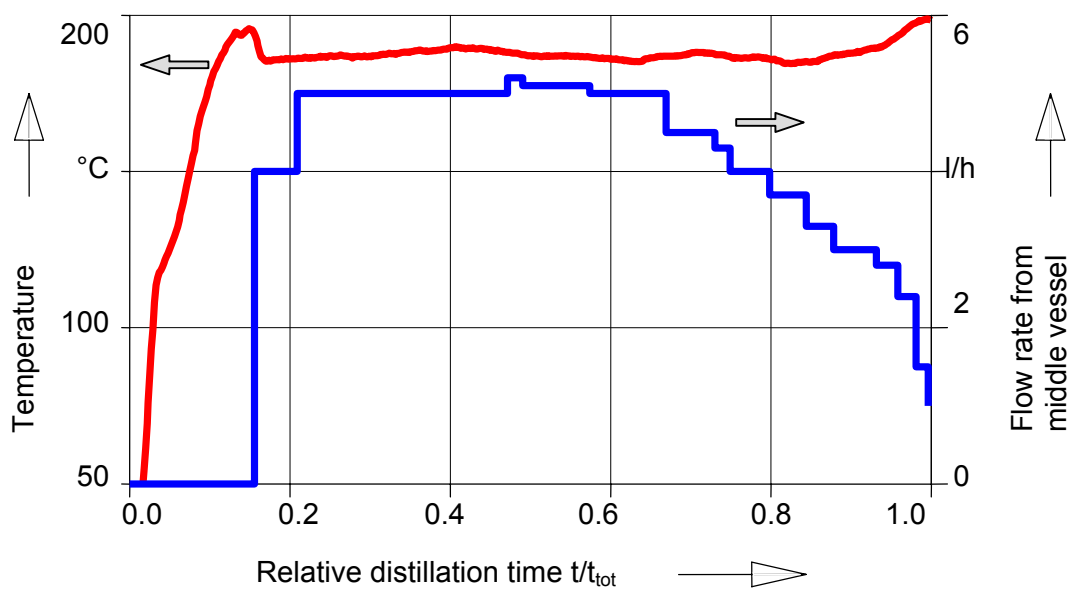

Fig. 11: Control of the temperature in the reboiler.

Advantages of Batch Extractive Distillation in a Column with a Middle Vessel over the Regular Column

A batch extractive distillation was also carried out in the plant run as a regular column. In this case, the feed (water-ethanol 50 mol%) was entirely charged to the reboiler. During the production of the most volatile component, entrainer was fed near the top of the column and the distillate was collected at constant reflux. When the temperature at the top of the column started increasing (decrease in purity of the distillate), the feeding of the entrainer was interrupted and a distillate off-cut was collected. This was followed by the production of the least volatile component of the feed, at constant reflux. The last step consisted in the purification of the entrainer from any residual contaminants.

A comparison of the batch extractive distillation in a regular column with the process described above, reveals the advantages of the middle vessel column concerning the temperature in the feed vessel, the demand of entrainer and the energy demand.

Temperature in the feed vessel

Figure 12 compares the concentration of the high boiling entrainer in the feed vessel and figure 13 shows a plot of the temperature in the feed vessel for both processes.

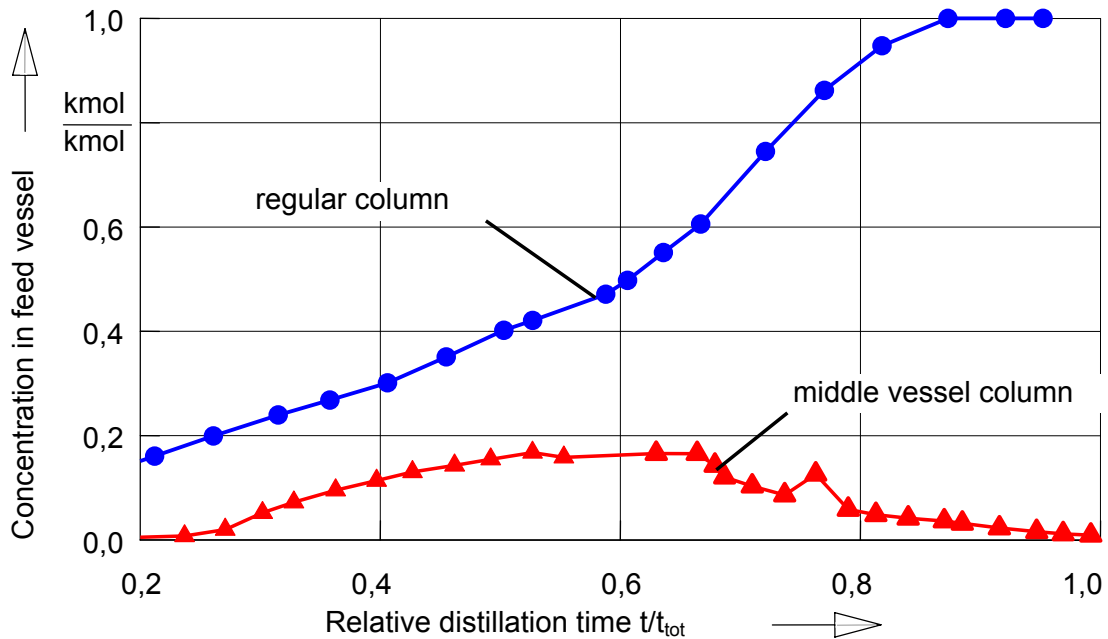

Fig. 12: Comparison of concentration of ethylene glycol in the feed vessel.

In the regular batch process all the entrainer fed to the column is accumulating in the feed vessel during the process (fig. 12). This amount of high boiling entrainer has a big influence on the temperature of the liquid in the feed vessel. Therefore, the temperature in the feed vessel for the process in the middle vessel column is significantly lower than that in a regular batch column (fig. 13). This can be important for substances which tend to decompose at high temperatures.

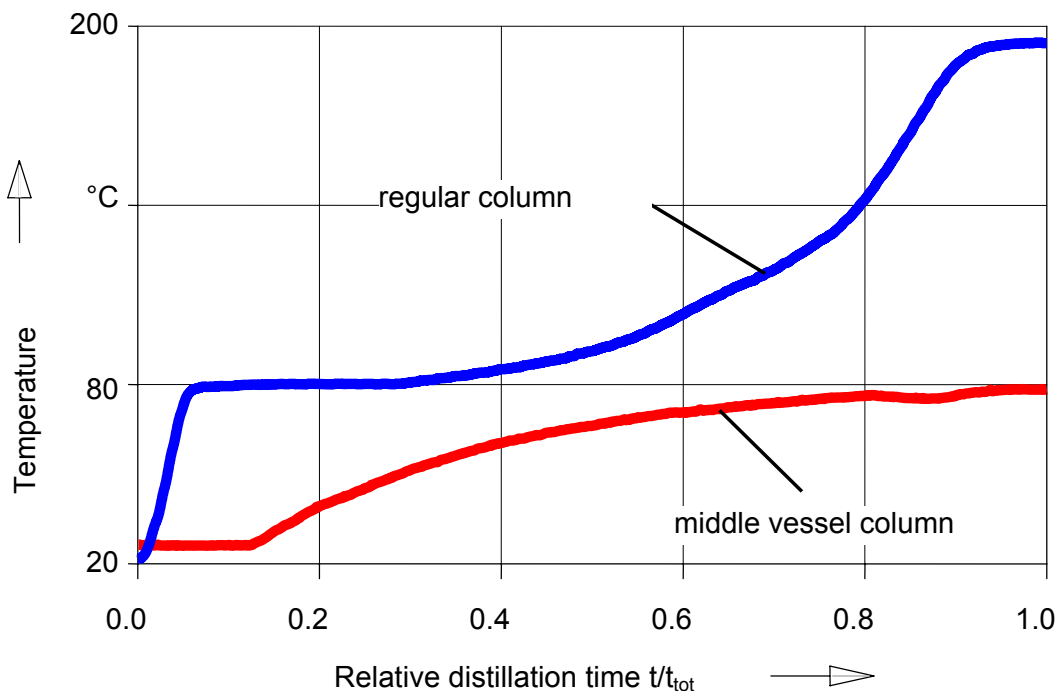

Fig. 13: Comparison of the temperature in the feed vessel.

Recycling of entrainer

Figure 14 shows that the volume of liquid accumulated in the sump of the column (B4) increases during the ethanol production step. This, together with the fact that the concentration of the entrainer in the sump is almost unity (fig. 9), makes it possible to recycle the entrainer to the top of the column during the ethanol production step, saving the amount of entrainer required per batch.

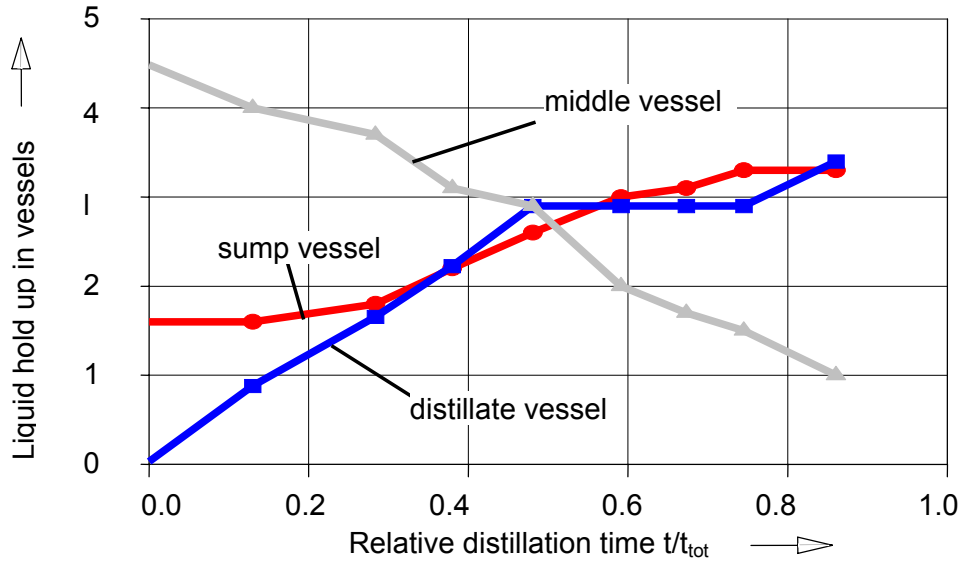

Fig. 14: Liquid hold-up in the sump, middle and distillate vessels.

SUMMARY

Batch distillation with a middle vessel is a combination of a regular and an inverted batch process. The feed vessel is connected with the middle of the column and it is possible to withdraw two fractions simultaneously from the top and the bottom of the column while an intermediate boiling fraction accumulates in the middle vessel. Many theoretical publications show the flexibility and the advantages of this type of process. Unfortunately there exist just a few experimental investigations for the separation of zeotropic mixtures and nearly none for the separation of azeotropic mixtures.

For own experiments, a regular batch column was extended to a middle vessel column so that the plant can be operated optionally either as a regular batch column or a column with a middle vessel.

Experiments for the separation of zeotropic mixtures show that a batch distillation column with a middle vessel can easily be operated in a "total reflux operation with constant hold-up" mode for the removal of light and heavy boiling impurities from an intermediate boiling product. In a second series of experiments the feasibility of a batchwise extractive distillation in a middle vessel column for the separation of a binary azeotropic mixture was demonstrated.

To compare the processes with the corresponding regular batch processes, the plant was operated as regular batch column. The results prove that batch distillation with a middle vessel offers many practical advantages such as a reduction in the temperature in the feed vessel, in the contact time with the hot surface of the reboiler and in the duration of the process start-up. It also offers the possibility to reduce the size of the reboiler. Furthermore, in a batchwise extractive distillation it is possible to directly recycle the entrainer from the sump to the feeding plate at the top of the column and hence, to reduce the amount of entrainer necessary for the separation.

Concluding, the experiments prove that by a minor modification of an existing regular batch column, the flexibility of the plant is extended and new types of batch processes with a middle vessel can be carried out. These avoid several of the disadvantages associated with the regular batch distillation.

NOTATION

<i>B</i>	Bottom fraction	<i>K1-K5</i>	Column sections
<i>D</i>	Distillate fraction	<i>B1-B6</i>	Vessels
<i>M</i>	Intermediate fraction	<i>T1</i>	Thermostat
<i>R</i>	Reflux ratio	<i>W1-W4</i>	Heat exchangers
<i>E</i>	Entrainer feeding rate	<i>V1-V13</i>	Valves
<i>t</i>	Time	<i>TR1-TR7</i>	Thermo-resistance elements
<i>t_{tot}</i>	Total distillation time	<i>P1-P2</i>	Pumps

Subscripts:

<i>α</i>	Start of a process step
<i>ω</i>	End of a process step

REFERENCES

1. C. S. Robinson and E. R. Gilliland (1950), Elements of Fractional Distillation, 4th Edition, McGraw-Hill, New York.
2. M. Warter (2001), Batch-Rektifikation mit Mittelbehälter, Fortschritt-Berichte VDI, Reihe 3 Nr. 686, VDI-Verlag, Düsseldorf, Germany (PhD thesis TU München).
3. P. Bartolini and G. B. Guarise (1970), Ing. Chim. Ital., 6 (9), 150-158.
4. A. G. Davydyan, V. N. Kiva, G. A. Meski and M. Morari (1994), Chem. Eng. Sci., 49 (18), 3033-3051.
5. U. M. Diwekar (1995), Batch Distillation: Simulation, Optimal Design and Control, Taylor & Francis, Bristol.
6. C. A. Farschman and U. M. Diwekar (1998), Ind. Eng. Chem., 37 (1), 89-96.
7. S. Hasebe, T. Kurooka, B. A. Aziz and I. Hashimoto (1996), J. Chem. Eng. Jpn., 29 (6), 1000-1006.
8. E. K. Hilmen, V.N. Kiva, and S. Skogestad, (1999) Comput. chem. Engng Suppl., S347-S350.
9. G. A. Meski and M. Morari (1995), Comput. chem. Engng, 19, S597-S602.
10. I. M. Mujtaba (1997), Trans. IChemE., 75 Part A, 609-619.
11. B. T. Safrit, A.W. Westerberg, U. Diwekar and O. M. Wahnschafft (1995), Ind. Eng. Chem. Res., 34 (10), 3257-3264.
12. B. T. Safrit and A.W. Westerberg (1997), Ind. Eng. Chem. Res., 36 (2), 436-443.
13. E. Sørensen (1997), Inst. Chem. Eng. Symp. Ser., 142, 643-652.
14. J. Stichlmair and J.R. Fair (1998), Distillation – Principles and Practice, Wiley & Sons, New York.
15. M. Warter and J. Stichlmair (2000), Computer-Aided Chemical Engineering, 8, 691-696.
16. M. Warter, and J. Stichlmair, Proc. CHISA 2000, Prag, Czech Republic.
17. M. Barolo, G. B. Guarise, S. A. Rienzi and A. Trotta (1994), Ind. Eng. Chem. Res., 33, 3160-3167.
18. M. Barolo, G. B. Guarise, N. Ribon, S. A. Rienzi, A. Trotta and S. Macchietto (1996b), Ind. Eng. Chem. Res., 35 (12), 4612-4618.
19. M. Barolo, G. B. Guarise, S. A. Rienzi and A. Trotta (1998), Comput. chem. Engng, 22 Suppl., S37-S44.

20. X. Cui, Z. Yang, H. Shao and H. Qu (2001), *Ind. Eng. Chem. Res.*, 40, 879-884.
21. LabVIEW (1994), Version 3.0.1 for Windows, National Instruments Corporation, Austin, Texas, USA.
22. M. Warter, D. Demicoli, and J. Stichlmair (2002), *Proc. European Symposium on Computer-Aided Chemical Engineering (ESCAPE 12)*, May 2002, The Hague, The Netherlands.
23. S. Hasebe, M. Noda and I. Hashimoto (1997), *Comput. chem. Engng*, 21 Suppl., S1221-S1226.
24. S. Hasebe, M. Noda and I. Hashimoto (1997), *Comput. chem. Engng*, 23, 523-532.
25. B. Wittgens, R. Litto, E. Sørensen, and S. Skogestad (1996), *Comput. chem. Engng*, 20 Suppl., S1041-S1046.
26. B. Wittgens and S. Skogestad (1997), *Inst. of Chem. Eng. Symp. Ser.*, 142, 239-248
27. B. Wittgens (1999), *Experimental Verification of Dynamic Operation of Continuous and Multivessel Batch Distillation*, Dissertation, The Norwegian University of Science and Technology.
28. M. Warter and J. Stichlmair (1999a), *Comput. chem. Engng*, 23, Suppl. S915-S918.
29. Speed-up 5.5-5, Version 5.5-5 for MS-Dos, Aspen Tech. UK Ltd, Sheraton House, Castle Park, Cambridge, England
30. M. Nitsche (1982), *Chem. Tech.*, 11 (3), 223-226.
31. E. K. Hilmen and S. Skogestad (1997), *Proc. AIChE Annual Meeting*, Los Angeles, USA.
32. J. R. Phimister and W. D. Seider (2000), *Comput. chem. Engng*, 24, 879-885.
33. V. Ruiz Ahón, J. L. de Medeiros (2001), *Comput. chem. Engng*, 25, 1115-1140.