

AUTOMATED TARGETING FOR PROPERTY INTEGRATION

Yin Ling Tan¹, Choon Hock Pau², Denny K. S. Ng³ and Dominic Chwan Yee Foo³,
Raymond R. Tan⁴

(1)School of Engineering and Science, Curtin University of Technology, Curtin University of
Technology Sarawak Campus Malaysia, CDT 250, Miri, 98009, Malaysia.

(2)EIS Sampling Sdn. Bhd., No. 148, Lot 3434, 1st Floor, Parkcity Commerce Square, Bintulu,
97000, Malaysia.

(3)School of Chemical and Environmental Engineering, University of Nottingham Malaysia,
Jalan Broga, Semenyih, Selangor, 43500, Malaysia.

(4) Chemical Engineering Department, De La Salle University-Manila
2401 Taft Avenue, 1004 Manila, Philippines.

ABSTRACT

Resource conservation is an effective way for reducing operation cost and to maintain business sustainability. Most previous works have been restricted to “chemo-centric” or concentration-based systems where the characterisation of the streams and constraints on the process sinks are described in terms of the concentration of pollutants. However, there are many applications in which stream quality is characterised by physical or chemical properties rather than pollutant concentration. In this work, the automated targeting approach originally developed for the synthesis of composition-based resource conservation network is extended for property-based network. Based on the concept of insight-based targeting approach, the automated targeting technique is formulated as a linear programming (LP) model for which the global optimum is guaranteed. Two literature examples are solved to illustrate the proposed approach.

Keywords: Process integration; Property integration; Resource conservation; Waste reduction; Property interception; Optimisation.

INTRODUCTION

Traditionally, process industries have been focusing on conventional end-of-pipe treatment. However, over the past decades, the center of attention has shifted to more sustainable operations via effective usage of resources. Amongst the few reasons that have resulted in this change include environmental sustainability, stringent emission legislation, as well as increasing of fresh resources and waste treatment costs.

In particular, mass integration which has been applied for material reuse/recycle, has become increasingly important over the past decade. Extensive works and efforts have focused in the area of mass integration. Recent reviews of mass integration can be found in literature (e.g. El-Halwagi, M.M., 1997, 1998, 2006; El-Halwagi and Springs, 1998; Dunn and El-Halwagi, 2003). Mass integration techniques have focused on tracking individual chemical species without considering other properties or functionalities of the streams. In response to this limitation, the notion of property integration, which takes into consideration the properties and functionalities of process stream, has been introduced by El-Halwagi and his co-workers.

Property integration is a functionality-based, holistic approach to the allocation and manipulation of streams and processing units that include the tracking, adjustment, assignment, and matching functionalities throughout the process (El-Halwagi et al., 2004). The concept of property integration is that the problem is mapped to a cluster domain, which achieve the same objective as mass integration (minimum resource usage and waste generation).

To further illustrate the concept of property integration, Shelley and El-Halwagi (2000) introduced a property-based cluster that was driven by tracking functionalities and properties of the streams instead of focusing on the chemical constituents. This technique was aimed to obtain the optimal recovery and allocation of the volatile organic compounds (VOCs) in complex hydrocarbon mixtures. Later, Kazantzi and El-Halwagi (2005) introduced a pinch-based graphical targeting technique, which is generalised from the conventional material reuse/recycle pinch diagram (El-Halwagi et al., 2003). On the other hand, Foo et al. (2006) presented both graphical (property surplus diagram) and algebraic (property cascade analysis) techniques to locate minimum resource targets within a property integration framework. Most recently, Pau (2007) extended the use of property cascade analysis (Foo et al., 2006) to determine rigorous targets for minimum fresh usage, waste discharge and interception targets of resource conservation network (RCN) with interception placement.

It is worth noting that property-based RCN synthesis has been explored in wide range of chemical processes. All the above mentioned works can basically be classified into insight-based and mathematical optimization techniques. To date, some works that utilised both insight-based and mathematical optimisation techniques have also been reported in the area of process integration. Among these works, the automated targeting approach presented by Ng et al. (2008) incorporated the targeting concept of insight-based technique into the mathematical optimisation model to locate the minimum flowrate/cost targets for a RCN. The proposed approach overcomes the limitations when both of the techniques are used independently.

In this work, the automated targeting technique (Ng et al, 2008) is extended for locating the minimum flowrate/cost targets for a property-based RCN. Two literature examples are solved to illustrate the proposed approach.

PROBLEM STATEMENT

Given a problem of resource conservation with single property may be stated as follows: In a process, a set of N_{sources} sources is given, which consist of process streams that may be reused/recycled or discharged. Each source has a flowrate, F_i and is characterised by a property P_i . A set of N_{sinks} process sinks that are process units that can accept sources is also given. Each sink requires a flowrate, F_j and an admissible inlet property, P_j from the source(s), which complies with the predetermined allowable property constraints as follow:

$$P_j^{\min} \leq P_j \leq P_j^{\max} \quad (1)$$

where P_j^{\min} and P_j^{\max} are the specified lower and upper bounds on admissible properties to unit sink j . Besides, a set of N_{fresh} external fresh resources can be purchased to fulfil the requirement of the sink(s).

A general property mixing rule is needed to define all possible mixing patterns among the individual properties. One such form of mixing rule takes the following expression (Shelley and El-Halwagi, 2000):

$$\psi(\bar{p}) = \sum_i x_i \psi(p_i) \quad (2)$$

where $\psi(p_i)$ and $\psi(\bar{p})$ are operators on property p_i and mixture property \bar{p} , respectively and x_i is the fractional contribution of stream i of the total mixture flowrate.

The objective of this work is to locate the minimum flowrate/cost targets for a property-based RCN prior to detailed design.

METHODOLOGY

The automated targeting technique was developed by Ng et al. (2008) based on the concept of algebraic targeting technique of cascade analysis (Manan et al., 2004), with the removal of the dual-step procedure. It is worth noting that in all cascade analysis techniques, infeasible cascades with material flow balances are first generated to determine the largest material deficit, which is then added as fresh resource in the second step to remove all deficits and yield a feasible material cascade. Successful application is seen in water network, utility gas network and property-based network synthesis. Via the proposed automated targeting approach, the two-step targeting approach is readily replaced. In this work, the automated targeting is adapted for a property-based RCN.

The procedure for the automated targeting technique for a property-based RCN is next illustrated. A revised *property interval diagram* (Foo et al., 2006) is first constructed, where the property operators (Ψ_k) of the material sinks and sources are arranged in an ascending order, from the lowest level $k = 1$ to the highest level $k = n$ (Figure 1). In cases where the property operator levels for fresh resource(s) and zero property operator level (i.e. $0 \text{ M}\Omega^{-1}$ (Foo et al., 2006)) do not exist among the process sinks and sources, an additional property operator level is added. Besides, an arbitrarily high property operator level is also added in last level of property interval diagram to allow the calculation of residue property load.

Next, *material flowrate cascading* across all property operator levels is to be performed. At each property operator level k , the difference between the total available material sinks ($\sum_j F_{\text{SK}j}$) and sources ($\sum_i F_{\text{SR}i}$) may be determined. Equation 3 shows the *net material flowrate* of each k -th level (δ_k). As shown, δ_k is the sum of the net material flowrate

cascaded from the earlier property operator level $(k - 1)$, δ_{k-1} with the flowrate balance at property operator level k , $(\sum_i F_{SRi} - \sum_j F_{SKj})_k$, i.e.:

$$\delta_k = \delta_{k-1} + (\sum_i F_{SRi} - \sum_j F_{SKj})_k \quad (3)$$

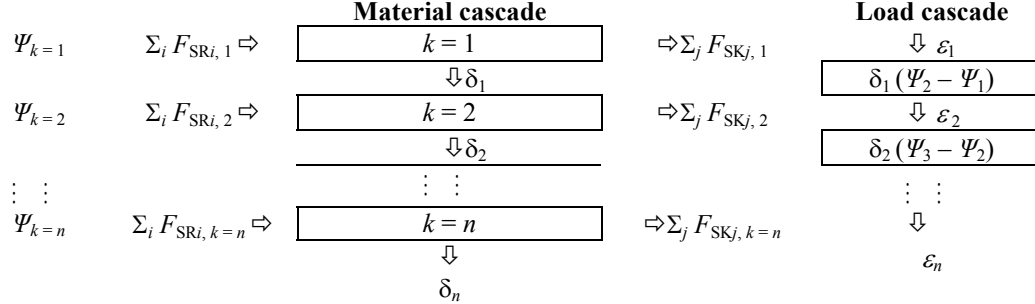

Figure 1 Property interval diagram.

Note that the net material flowrate (δ_k) can either take positive or negative value, with positive value indicates material that flows from the lower level into higher level or vice versa. This is in agreement with the cascade analysis technique.

Apart from material flowrate cascading, *property load cascade* is also essential to ensure a feasible RCN. Property load cascading from level $k - 1$ to level k is performed as follows. Within each property operator interval, the property load is given by the product of the net material flowrate from level k and the difference between two adjacent property operator levels. Similar to the material flowrate cascade, residual property load of each concentration level k (ϵ_k) is to be cascaded down to the next property operator level. Hence, property load balance at the k -th concentration level is determined by

$$\epsilon_k = \epsilon_{k-1} + \delta_k (C_{k+1} - C_k) \quad (4)$$

where ϵ_{k-1} is the residual property load that is cascaded from concentration level $k - 1$.

In order to ensure maximum allowable property load of sink in each level is fulfilled, and the property load is transferred from lower to higher level, the residual property load, ϵ_k must take a positive value (Equation 5). Therefore, Equation 5 is included as a constraint in the optimisation model. Note also that, a pinch point is observed where the residue property load is zero along the cascade.

$$\epsilon_k \geq 0 \quad (5)$$

In order to target the minimum fresh resource and waste generation flowrates for a direct reuse/recycle scheme, the property interval diagram may be converted to a *property-based cascade diagram* (PRCD) as in Figure 2. Based on the previous proposed procedure, the property operators of the sink and source are first arranged in an ascending order as shown in Figure 2. Next, utilising Equation 3, the net material flowrate of each property operator level k (δ_k) is determined. It is interesting to note that the net material

flowrate found before the first property operator (δ_0) and final property operator (δ_k) levels corresponds to the fresh resource (F_{FR}) and waste discharge (F_W) flowrates of the network respectively (Figure 2). Normally, the fresh resource is of the highest quality, and corresponds to zero property operator. In cases where the fresh resource does not exist at the zero operator value, a new property operator level ($\Psi_{FR II}$) is to be added (see Figure 2).

In order to determine the minimum total fresh resource flowrate $\sum(F_{FR} + F_{FR II})$, the objective function for the mathematical optimisation model is formulated as:

$$\min \sum(F_{FR} + F_{FR II}) \quad (6)$$

subject to the constraints in Equations 3 to 5.

It is worth noting that the above optimisation model is a linear programming (LP) problem, which can be solved easily to achieve global optimal solution if one exists. Two different case studies has been modeled and applied in LINGO software to prove the applicability of the methodology. These case studies have been used to demonstrate the flexibility of the automated targeting approach to analyse the interaction between the pre-treatment systems with the RCN.

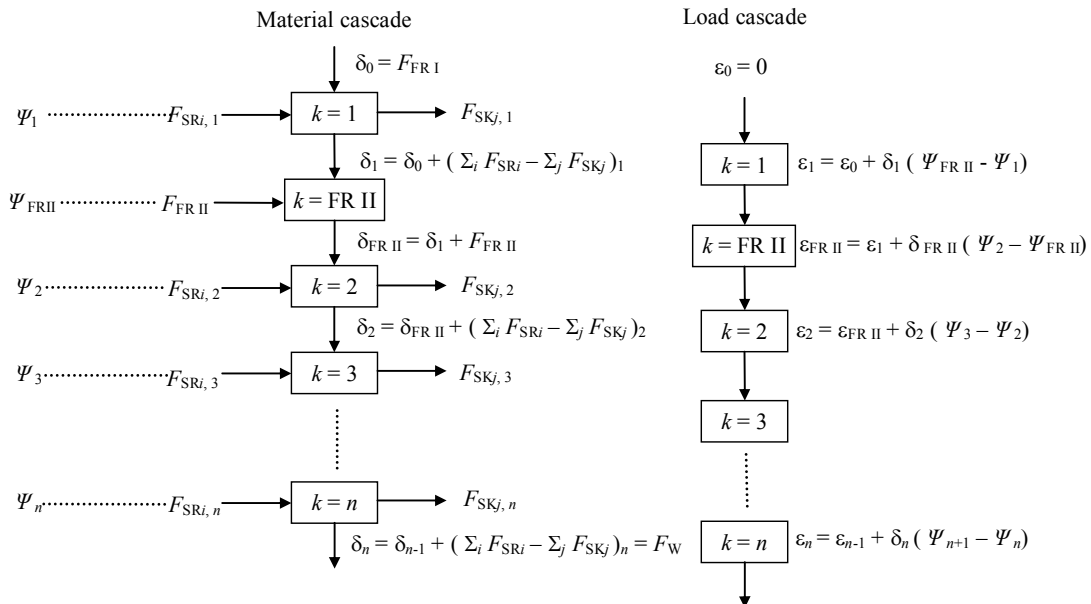

Figure 2 Generic PRCD for direct reuse/recycle.

EXAMPLE 1

A metal degreasing process taken from Kazantzi and El-Halwagi (2005) is used to illustrate the proposed approach, with the schematic flowsheet shows in Figure 3. As shown, a fresh organic solvent is used in the degreaser where reactive thermal processing is used to decompose grease and organic additives. Then, the liquid solvent is

regenerated from the solvent regeneration unit and reused in the degreaser; while the gases containing solvent is passed through a condenser and absorber before being flared. Besides, the fresh solvent is used in the absorber to capture light gases that escape from the solvent regeneration unit. Note that the process produces two condensate streams that may serve as process sources, i.e. from the solvent regeneration unit (SR1) and the degreaser (SR2). Reuse/recycle of the process sources (SR1 and SR2) can be considered to reduce the consumption of the fresh solvent. In this case, there are two process sinks where solvent is needed, i.e. degreaser (SK1) and absorber (SK2).

The main property of the solvent that dictates the extent of reuse/recycle of the process sources is the Reid Vapour Pressure (RVP), which is important in characterising the volatility (and, indirectly, the composition) of the solvent. The general mixing rule for the RVP is given as below (Kazantzi and El-Halwagi, 2005):

$$\overline{\text{RVP}}^{1.44} = \sum_i x_i \text{RVP}_i^{1.44} \quad (7)$$

The property operator for RVP, $\Psi(\text{RVP})$, can thus be expressed as follows:

$$\Psi(\text{RVP}_i) = \text{RVP}_i^{1.44} \quad (8)$$

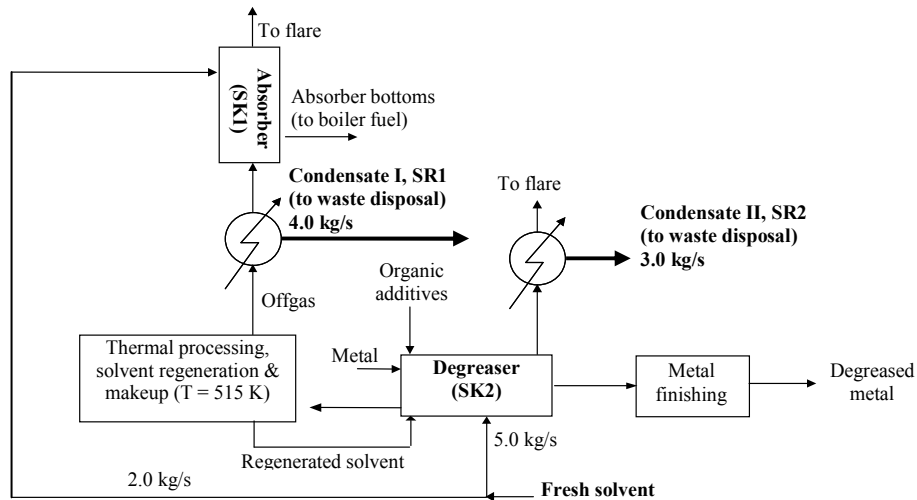

Figure 3 Schematic flowsheet of metal degreasing process (Kazantzi and El-Halwagi, 2005).

Table 1 shows the limiting data for Example 1. Note that the fresh solvent has a relatively low operator value as compare to the two process sources (SR1 and SR2). In order to maximise solvent recovery from the process sources, the upper bound of the operator for each process sink is used to construct PRCD.

Table 1 Limiting data for Example 1 (Kazantzi and El-Halwagi, 2005).

Process	Flowrate (kg/s)	Reid Vapor Pressure, <i>RVP</i> (atm)		Property operator, ψ (atm ^{1.44})	
		Lower bound	Upper bound	Lower bound	Upper bound
(Sink)					
Degreaser (SK1)	5.0	2.0	3.0	2.71	4.87
Absorber (SK2)	2.0	2.0	4.0	2.71	7.36
(Source)					
Condensate I (SR1)	4.0		6.0		13.2
Condensate II (SR2)	3.0		2.5		3.74
Fresh solvent	To be determined		2.0		2.71

Equation 6 is solved subject to the constraints in Equations 3 – 5, yielding the solution as in the PRCD (Figure 4). Note that, a zero property operator ($\Psi_1 = 0 \text{ atm}^{1.44}$) is added in the first level of PRCD because none of the sink or source with zero property operator. On the other hand, an imaginary property operator level ($\Psi_7 = 100 \text{ atm}^{1.44}$) is added at the last level of PRCD to allow residual property load to be computed. As shown in Figure 4, the targeted fresh (F_{FR}) and waste solvent (F_W) flowrates are both found as 2.38 kg/s, matching the reported results in the literature (Bandyopadhyay, 2006; Kazantzi and El-Halwagi, 2005; Foo et al., 2006). The pinch point is identified as 13.2 atm^{1.44}, where zero residual property load ($\varepsilon_5 = 0$) is observed. The network design for this case is shown in Figure 5.

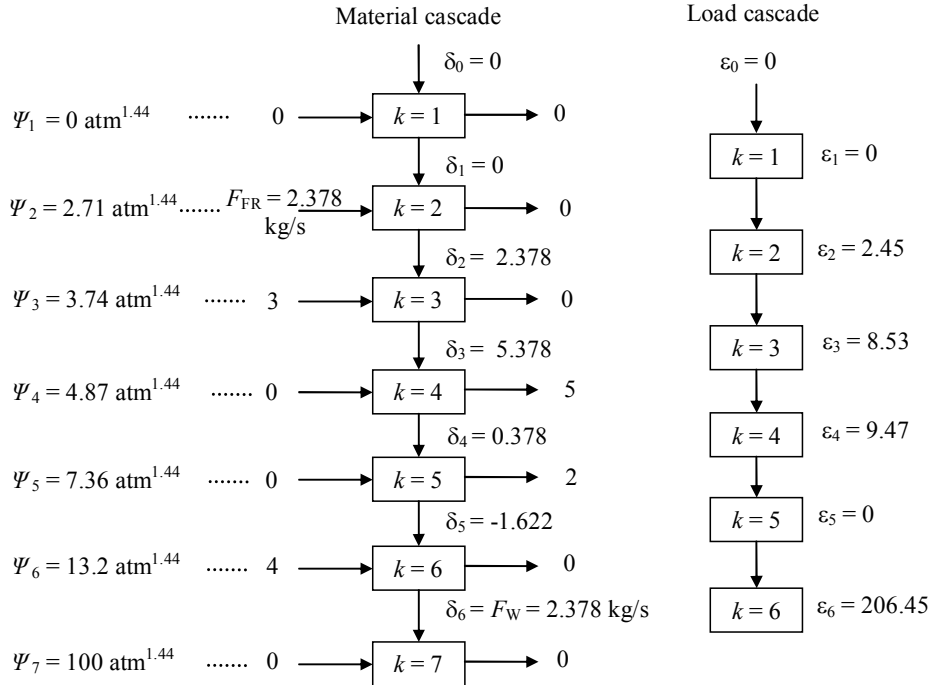

Figure 4 PRCD for Example 1.

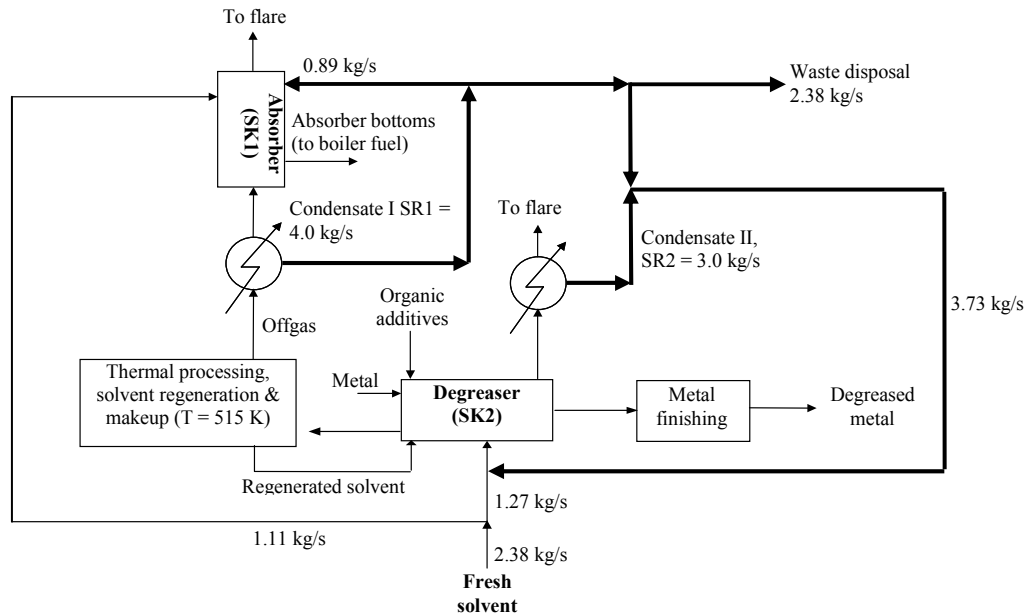

Figure 5 Network design for metal degreasing process with solvent reuse/recycle (Example 1).

EXAMPLE 2

An industrial wafer fabrication process is used to illustrate the competence of automated targeting for the synthesis of a RCN with pre-treatment system. In this example, the pre-treatment system is used to generate ultra-pure water to fulfil the process requirements. The water pre-treatment system consists of three main elements which are ultra-filtration (UF), reverse osmosis (RO) and deionisation (DI). The ultra-filtration is used to retain the solute of high molecular weight in the municipal fresh water. Meanwhile, reverse osmosis (RO) and deionisation (DI) processes are used to remove the ions that solute in the water and deionise the water in order to generate ultra pure water (UPW). In this work, it is assumed that 70% of the inlet flowrate of UF passes through the membrane as permeate; while, 30% of the flowrate is rejected as wastewater with constant water quality, and the same assumption applies for the RO in the pre-treatment system. In order to reduce the fresh water consumption, the recovery of rejected stream from the pre-treatment system can be considered. It is notable that the rejected flowrate is dependent on the amount of water that is fed to the pre-treatment system. This dependency enables the interactions between pre-treatment system and water network to be explored.

Figure 6 shows a schematic diagram for wafer fabrication process with water pre-treatment system. As shown in Figure 6, there are four sections in the wafer fabrication (FAB) process that require UPW supply, denoted as “Wet,” “Lithography,” “CMP” (i.e., combined chemical and mechanical processing) and “etc.” (other miscellaneous processes). Besides, cleaning section, cooling tower makeup and scrubber as well as pre-treatment system necessitate an external supply of municipal fresh water. Note that the Wet and CMP sections generate two wastewater streams with different water quality

levels. Besides, there are seven water sources that can be considered for water recovery. In this example, the most significant water quality factor was determined to be resistivity (R) which constitutes an index of the total ionic content of aqueous streams. The general mixing rule for resistivity is shown as below (El-Halwagi, 2006):

$$\frac{1}{\bar{R}} = \sum_i \frac{x_i}{R_i} \quad (9)$$

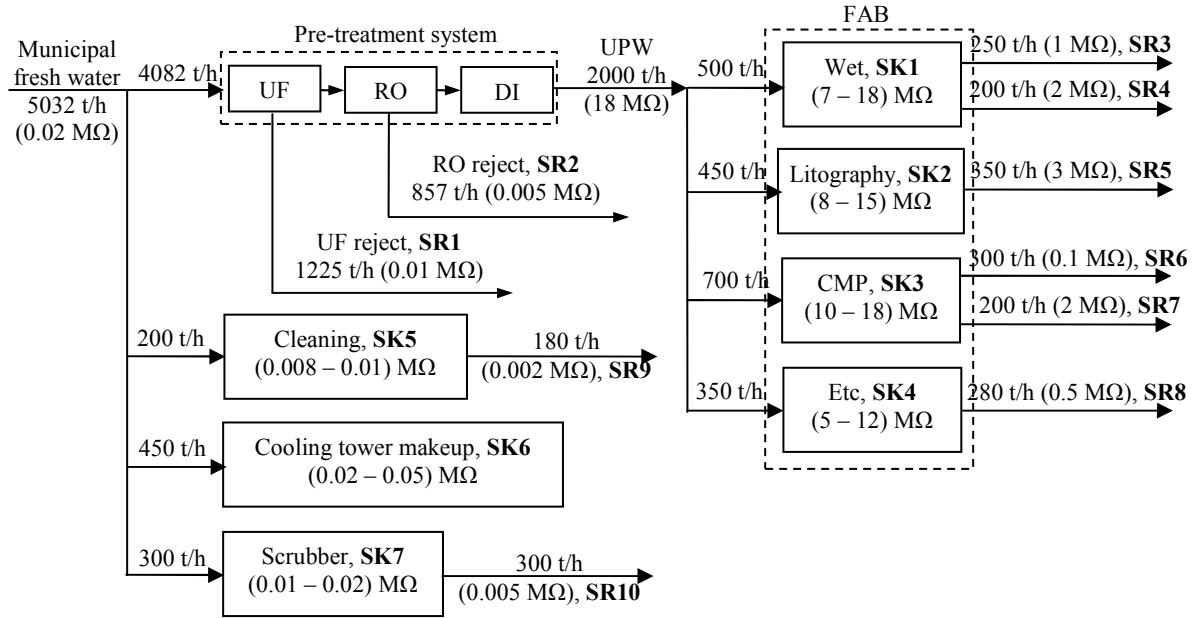

Figure 6 Schematic diagram for wafer fabrication process (Example 2).

Note that the property operator for resistivity is defined as the inverse of resistivity (R^{-1}), such that the lowest resistivity also corresponds to the lowest quality level. Table 2 summarises the pertinent data for the sinks and sources. In this example, the lower bounds of the resistivity are selected as the limiting property for process sink when water recovery scheme is considered, because these lower bounds correspond to the lowest stream quality that can be tolerated by the processes, and thus maximises the potential for reuse and recycling.

Since the rejected wastewater from UF and RO systems depend on the inlet flowrate of municipal fresh water into pre-treatment system, equations below are also included in the optimisation model.

$$F_{in}^{UF} = F_p^{UF} + F_R^{UF} \quad (10)$$

$$F_{in}^{RO} = F_p^{RO} + F_R^{RO} \quad (11)$$

where F_{in}^{UF} and F_{in}^{RO} are the inlet flowrate to the UF and RO system respectively. Meanwhile, F_p^{UF} and F_R^{UF} represent permeate and retentate flowrates for UF system; F_p^{RO}

and F_R^{RO} are the flowrate of permeate and retentate streams for RO system. Since all the permeate flowrate of UF and RO systems is directly sent to next treatment unit to generate UPW; therefore, F_{In}^{RO} is equivalent to F_P^{UF} , and UPW flowrate (F_{UPW}) is same as F_P^{RO} . By combining Equations 10 and 11 leads to equation below:

$$F_{In}^{UF} = F_R^{UF} + F_R^{RO} + F_{UPW} \quad (12)$$

Table 2 Limiting data for Example 2.

Process	Flowrate (t/h)	Resistivity, R ($M\Omega$)		Property operator, ψ ($M\Omega^{-1}$)	
		Lower bound	Upper bound	Lower bound	Upper bound
(Sink)					
Wet (SK1)	500	7	18	0.1429	0.0556
Litography (SK2)	450	8	15	0.1250	0.0667
CMP (SK3)	700	10	18	0.1000	0.0556
Etc (SK4)	350	5	12	0.2000	0.0833
Cleaning (SK5)	200	0.008	0.01	125	100
Cooling tower makeup (SK6)	450	0.02	0.05	50	20
Scrubber (SK7)	300	0.01	0.02	100	50
(Source)					
UF reject (SR1)	30% inlet flowrate of UF		0.01		100
RO reject (SR2)	30% inlet flowrate of RO		0.005		200
Wet I (SR3)	250		1		1
Wet II (SR4)	200		2		0.5
Litography (SR5)	350		3		0.3333
CMP I (SR6)	300		0.1		10
CMP II (SR7)	200		2		0.5
Etc (SR8)	280		0.5		2
Cleaning (SR9)	180		0.002		500
Scrubber (SR10)	300		0.005		200
Ultra pure water (UPW)	To be determined		18		0.0556
Municipal fresh water (FW)	To be determined		0.02		50

In addition, as discussed previously, 30% of the inlet flowrate for UF and RO systems is rejected as wastewater; thus, equations 13 and 14 are also included in the optimisation model.

$$F_R^{UF} = 0.3 \times F_{In}^{UF} \quad (13)$$

$$F_R^{RO} = 0.3 \times F_{In}^{RO} \quad (14)$$

Following the proposed automated targeting technique, the optimisation model is solved subject to minimise total municipal fresh water, F_{TFW} (fresh water for pre-treatment, F_{In}^{UF} and fresh water for water network, F_{FW}) with constraints of Equations 3 – 5. The PRCD for Example 2 is generated in Figure 7. Note that the total municipal fresh water and wastewater targets are found to be 3095 t/h (= 928.5 t/h + 649.95 t/h + 1516.55 t/h) and 2205 t/h, respectively. Note that all the municipal water is passed through the pre-

treatment system to form UPW. The optimal water recovery scheme for Example 2 is showed in Figure 8.

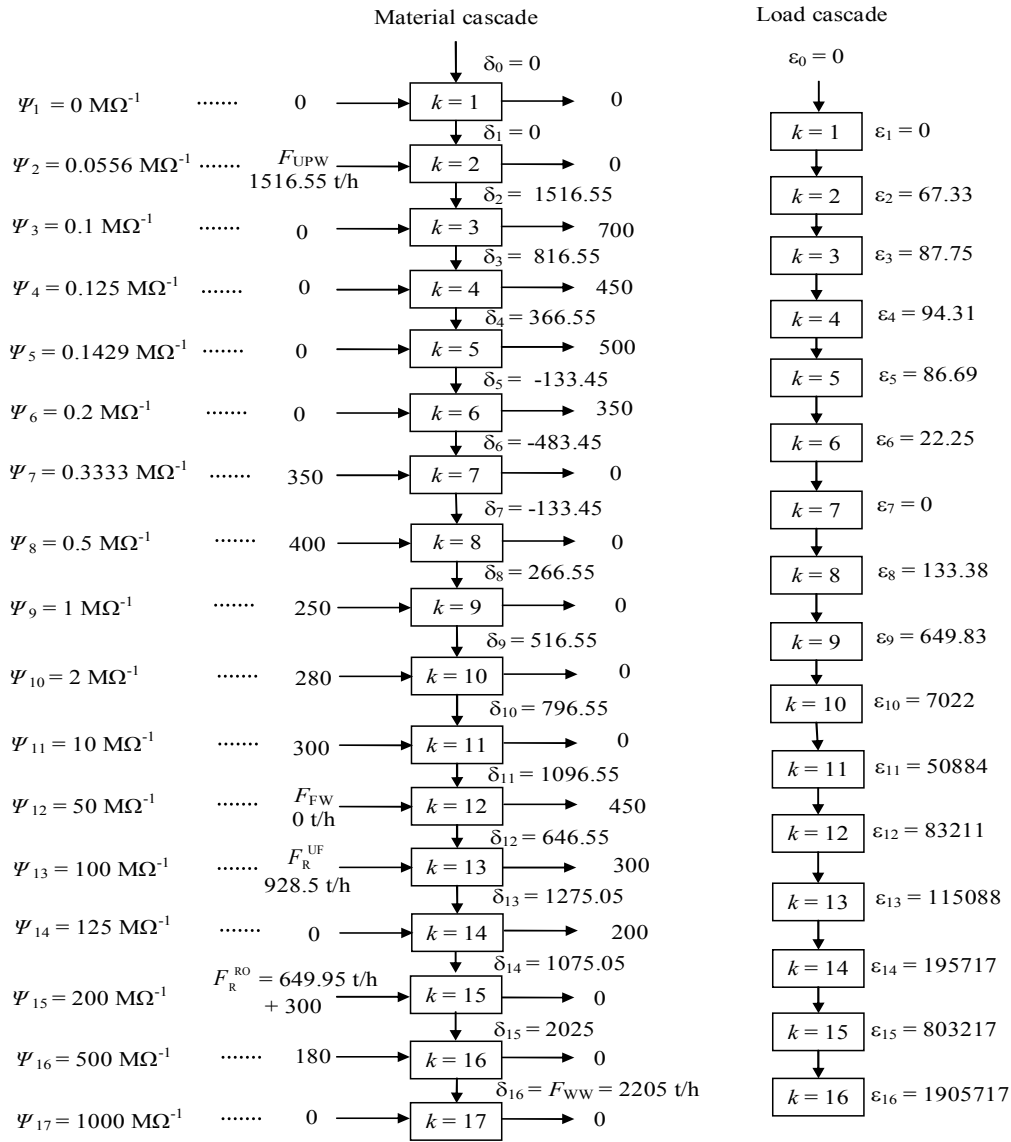

Figure 7 PRCD for Example 2

CONCLUSION

In conclusion, this work presents the extension of automated targeting technique to establish the resource targets within a property integration framework. The automated targeting combines the advantages of both insight-based and mathematical optimisation approaches. Two examples have been solved using this approach.

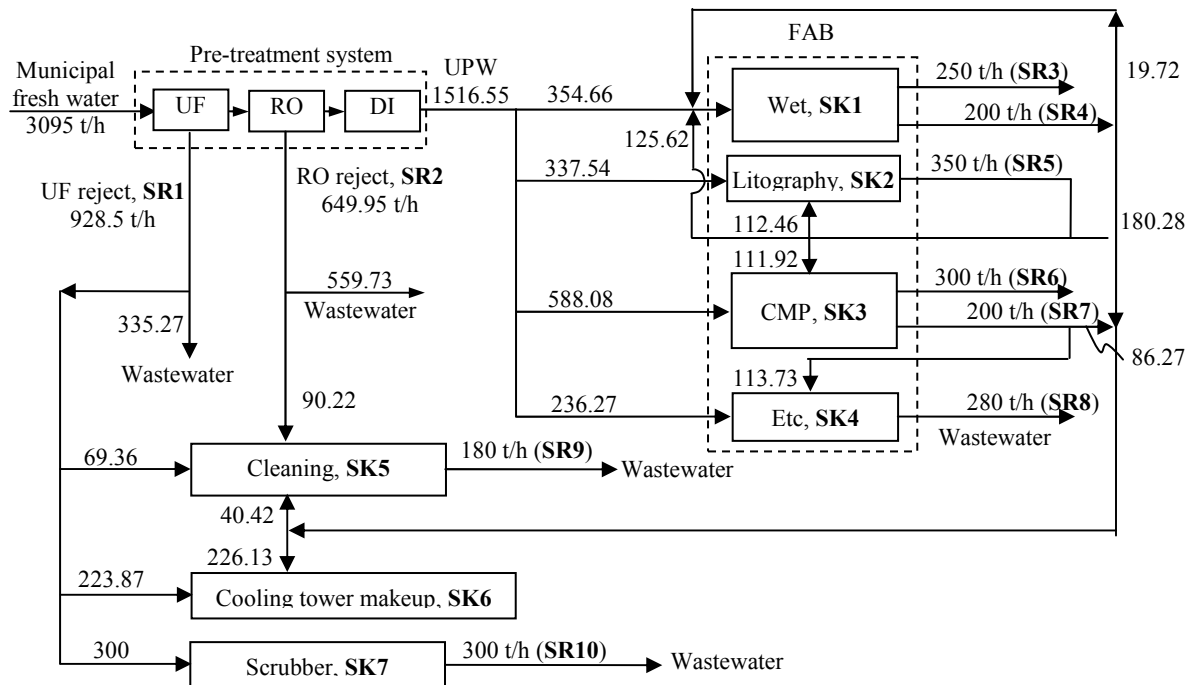

Figure 8 Optimal water recovery scheme for wafer fabrication process (Example 2).

REFERENCES

1. Almutlaq, A.M., Kazantzi, V., El-Halwagi, M.M., 2005. An algebraic approach to targeting waste discharge and impure fresh usage via material recycle/reuse networks. *Clean Technology and Environmental Policy* 7 (4), 294-305.
2. Bandyopadhyay, S., Source composite curve for waste resuction. *Chem. Eng. J.* 125 (2006) 99-110.
3. El-Halwagi, M.M., 1997. *Pollution Prevention through Process Integration: Systematic Design Tools*. Academic Press, San Diego.
4. El-Halwagi, M.M., 2006. *Process Integration*. Elsevier Inc., Amsterdam, Netherlands.
5. El-Halwagi, M.M., Springgs, H.D. 1998. Solve deign puzzles with mass integration. *Chemical Engineering Progress* 94, 25-44.
6. El-Halwagi, M.M., Gabriel, F., Harell, D., 2003. Rigorous graphical targeting for resource conservation via material recycle/reuse networks. *Industrial and Engineering Chemistry Research* 42, 4319-4328.
7. El-Halwagi, M.M., Glasgow, I.M., Eden, M.R., Qin, X., 2004. Property integration: componentless design techniques and visualization tools. *A.I.Ch.E. Journal* 50 (8), 1854-1869.
8. Foo, D.C.Y., Kazantzi, V., El-Halwagi, M.M., Manan, Z.A., 2006. Surplus diagram and cascade analysis technique for targeting property-based material reuse networks, *Chemical Engineering Science* 61(8), 2626-2642.
9. Kazantzi, V., El-Halwagi, M.M., 2005. Targeting material reuse via property integration. *Chemical Engineering Progress* 101 (8), 28-37.
10. Kuo, W.C.J., Smith, R., 1998. Design of water-using system involving regeneration. *Transactions of the Institute of Chemical Engineers, Part B*, vol 76, 94-114.

11. Manan, Z. A., Tan, Y. L., Foo D. C. Y., 2004. Targeting the minimum water flowrate using water cascade analysis technique. *AIChE J.* 50(12) 3169-3183.
12. Ng, D.K.S., Foo, D.C.Y., Tan, R.R., Tan, Y.L., 2007. Ultimate flowrate targeting with regeneration placement. *Chemical Engineering Research and Design, Trans IChemE Part A*, vol.85 (A8), 1-5.
13. Ng, D. K. S., Foo, D. C. Y., Tan, R. R., Automated targeting technique for resource conservation networks. *An international Conference on Water & Wastewater (Asia Water 2008) (2008)*.
14. Pau, C. H., 2007. Property integration network with regeneration placement. Thesis of final year research project. Curtin University of Technology.
15. Shelley, M.D., El-Halwagi, M.M., 2000. Componentless design of recovery and allocation systems: a functionality-based clustering approach. *Computers and Chemical Engineering* 24, 2081-2091.