

Active Noise Control for Selective Cancellation of External Disturbances

S. Hu, R. Rajamani, and X. Yu

Abstract— A significant problem associated with active noise control (ANC) systems for home windows is that they use direct microphone measurements for reference and error signals. When other sound besides external noise (e.g. music or speech) exists inside a home, the reference and error microphone measurements are “polluted”. Using the “polluted” measurements as reference and error signals has adverse effects on the ANC system. This paper proposes to integrate the ANC system with a wave separation algorithm, which separates the “unpolluted” reference and error signals from the direct microphone measurements. The performance of the resulting ANC system with wave separation is experimentally tested in a cabin equipped with a window and results are presented. Experimental results show that the new system is able to preserve desired internal sound while cancelling uncorrelated external noise.

I. INTRODUCTION

FOR homes close to airports and highway, windows constitute the primary path through which noise enters the home. For example, a typical frame wall may weigh 70 kg/m^2 , while a typical single glazed window weighs about 7 kg/m^2 . Consequently, the window can transmit roughly ten times as much sound energy as is transmitted through the same area of wall [1]. In studying the effectiveness of various measures in improving building insulation against traffic noise, Utley, *et al.* [2] concluded that window improvements provide the most satisfaction to home dwellers. The traditional passive method to reduce noise transmitted through windows is using sealed double-glazed windows in which two panes of glass are separated by a few millimeters of air cavity. The performance of double-glazed window is poor for low frequencies ($<1 \text{ kHz}$), such as traffic noise [3]. The sound transmission loss of a double-glazed window is greater than 40dB at 2 kHz but decreases to 20dB at 100Hz. Active noise control (ANC) is a better solution for reduction of low frequency noise.

In ANC, a secondary source creates an “anti-noise” to superimpose on the unwanted primary noise. Since the “anti-noise” has the same amplitude but a 180° phase difference with the primary noise, the superposition results in a reduced decibel level of noise in the environment. Two main approaches of actively controlling sound transmission into a room have been proposed in literature. The first approach,

loudspeaker-based active noise control, uses loudspeakers as the secondary source. The loudspeakers can be placed either inside the room (room control) [4-5], or in the cavity through which sound enters the room (cavity control) [6-8]. The complex acoustical field in a room makes the room control approach less effective and reliable than the other approaches. The traditional cavity control approach requires the use of relatively large loudspeakers which makes it unsuitable for use when the cavity consists of a “window”. The other approach is active structural acoustic control (ASAC). In this approach thin panels, such as the glass panes in the window, are used as loudspeakers and their vibration is actively controlled by vibration inputs, yielding the so-called “panel speakers” [9-10]. ASAC has better potential for the window ANC application than room and cavity control. The authors have previously developed a transparent thin film acoustical actuator that can be easily integrated as part of the window and used as the panel speaker for ASAC [11]. Figure 1 shows the developed transparent thin film actuator. Because of its high optical transmittance, the transparent film will not destroy the aesthetics and function of the windows.

The “anti-noise” control action sent to the secondary source is computed by an ANC algorithm. Typical ANC algorithms include feedback control and feedforward control. Feedback control is useful in applications where a time-advanced reference signal about the primary noise is difficult or impossible to obtain. However, without knowledge of the primary noise from a reference signal, feedback control can only effectively deal with time-invariant noise. When a reference signal is available, feedforward is significantly more effective at noise attenuation and is typically the control system utilized. In the case of feedback control, the phase-shift in the control loop introduced by electronic circuitry, the actuator, and the sound transmission path will also risk making the system unstable when high gains are used to improve performance.



Figure 1: Transparent thin film speaker used in window active noise control system by X. Yu *et al.*

This work is supported by funding from the National Science Foundation (Grant CMMI 0927216).

S. Hu and R. Rajamani are with the University of Minnesota Minneapolis, MN, 55455, Email: shanhu@me.umn.edu, rajamani@me.umn.edu.

X. Yu is with the University of Minnesota, Duluth, MN, 55812, Email: xunyu@d.umn.edu.

II. FEEDFORWARD FXLMS ALGORITHM

For this research, feedforward Filtered-X Least Mean Square (FXLMS) is used as the control algorithm for our ANC system. Figure 2 is the block diagram of the feedforward FXLMS algorithm. $x(n)$ is the reference signal measured by an upstream reference microphone; $x'(n)$ is the filtered version of $x(n)$; $e(n)$ is the residual noise at downstream measured by an error microphone; $y(n)$ is the control signal sent to actuator; $P(z)$ is the unknown transfer function of sound transmission path from the reference microphone to the error microphone; $S(z)$ is the secondary path from $y(n)$ to $e(n)$. To compensate the delay caused by the secondary path transfer function, $\hat{S}(z)$ an estimation of $S(z)$, is introduced before the LMS algorithm resulting in the so-call FXLMS algorithm. In this research, $\hat{S}(z)$ was off-line identified by the method described in reference [5]. $W(z)$ is the adaptive digital filter that is used by the LMS algorithm to generate control signals. The LMS adaptation law for the coefficients of the filter $W(z)$ can be found as [12]:

$$w(n+1) = w(n) + \mu \hat{x}(n)e(n) \quad (1)$$

where μ is the adaptation step size and $\hat{x}(n)$ is the convolution of $\hat{S}(z)$ and $x(n)$. Once the coefficients of $W(z)$ have been updated, the active noise control signal $y(n)$ will be created as follows:

$$y(n) = W(z)x(z) = \sum_{l=0}^{L-1} w_l(n)x(n-l) \quad (2)$$

where L is filter length. This control signal will cancel noise that has strong correlation with the reference signal.

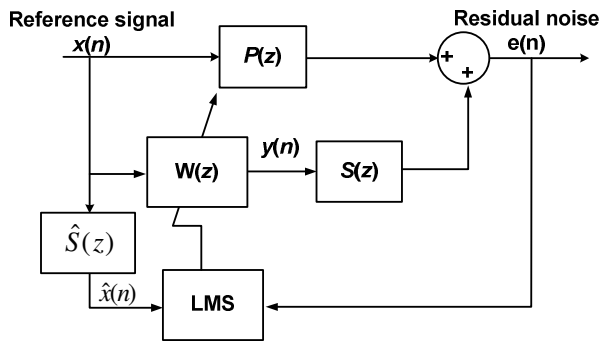

Figure 2: Flow chart of the feedforward FXLMS control algorithm.

III. INTEGRATION METHOD FOR THE WAVE SEPARATION

As discussed in Section II, the ANC system uses an upstream microphone to pick up primary noise as a reference signal and a downstream microphone to measure the superposition of the noise and “anti-noise” as an error signal. Unfortunately, the reference microphone will also pick up other sound that co-exists with the reference signal in the acoustic field, resulting in deterioration of the noise control results. For example, picking up the “anti-noise” generated by the secondary source that travels upstream will result in an adverse effect called “feedback effect” [3]. Picking up the primary noise reflected by the window to upstream can lead to instability during FXLMS adaptation. Picking up the internal sound (such as music and speech) radiated through

the window to upstream will result in cancellation of the music and speech in homes. The error microphone placed inside the homes will also pick up the internal sound, which will cause a slow-down in the convergence rate of the FXLMS algorithm.

To mitigate the adverse effects caused by the “polluted” reference and error signals, we proposed to use an acoustic wave separation algorithm. Wave separation can separate the sound at any point into components based on their direction of travel. It is used in this paper to separate the external noise and its superposition with “anti-noise” from the internal sound picked up by the reference and the error microphones.

The set up of the integration method for wave separation is shown in Figure 3. The wave separation algorithm utilizes two microphones which are a few inches apart. For successful wave separation, the two microphones used should have matched frequency response. The pair of microphones is placed between the two sound sources which send acoustic waves ($P_i(t)$ and $P_e(t)$) travelling in opposite direction. The distance between two microphones is d ; and $P_1(t)$ and $P_2(t)$ are the acoustic pressure signals picked up by the two microphones. It is assumed that distance d is small compared to the wavelength of sound waves to be separated. Normal incidence of sound to microphones and one-dimensional plane wave transmission are also assumed. To separate three-dimensional sound wave, additional microphones need to be added and a three-dimensional form of the wave separation algorithm given below needs to be used.

The sound P_i and P_e travelling in opposite directions can be separated by the integration method given in reference [13] as follows:

$$P_i(t) = \frac{1}{2} [P(t) - \rho_0 c u(t)] \quad (3)$$

$$P_e(t) = \frac{1}{2} [P(t) + \rho_0 c u(t)] \quad (4)$$

where ρ_0 is the density of air, c is the speed of sound, and $P(t)$ is the sound pressure at the midpoint of the two microphones. Hence

$$P(t) = \frac{1}{2} [P_1(t) + P_2(t)] \quad (5)$$

and $u(t)$ is the particle velocity calculated as:

$$u(t) = \frac{1}{\rho_0 d} \int_0^t [P_1(\tau) - P_2(\tau)] d\tau \quad (6)$$

In real practice, Equations (3) to (6) have to be implemented in discrete time. To calculate $P_i(n)$ and $P_e(n)$, $P_1(n)$ and $P_2(n)$ are first measured by the pair of microphones. Then $P(n)$ is calculated by Equation (5) and $u(n)$ is computed by numerical integration. Finally, $P_i(n)$ and $P_e(n)$ are obtained by Equations (3) and (4). It is interesting to note that besides the direction of travel, successful wave separation does not have any other requirements on properties of the sound waves to be separated such as their amplitudes, correlations, etc.

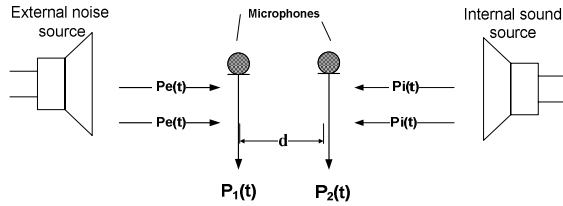

Figure 3: The integration method for wave separation.

IV. ANC SYSTEM INTEGRATED WITH THE WAVE SEPARATION ALGORITHM

Figure 4 shows a schematic drawing of the ANC system integrated with the wave separation algorithm. A $1.1 \times 0.9 \times 2$ m³ cabin with a window (200×200 mm²) on one side is used to simulate a room under the impact of noise. The thin film speaker is placed right next to the window pane inside the cabin and is driven by the active noise controller. The window consists of a wood frame and a glass pane of thickness 18mm. The actuator's thickness is $\sim 28 \mu\text{m}$. Two woofer speakers are located on the outside and inside of the cabin to simulate the external noise source and internal music or speech. Both speakers are ~ 58 cm from the window. A pair of omni-directional microphones is placed on each side of the window with the pair closer to the noise source as the reference microphones, and the other pair as the error microphones. The reference microphone pair is 6.35 cm apart and the error microphone pair is 7.62 cm apart. The microphone outputs were pre-amplified and filtered before entering the data acquisition card. A CIO-DAS 6402/12 (Measurement Computing, Norton, MA) data acquisition is used for data communication between a PC and speakers/microphones. The control algorithm is implemented via a PC real time toolbox in Turbo C. The sampling period is $150 \mu\text{s}$.

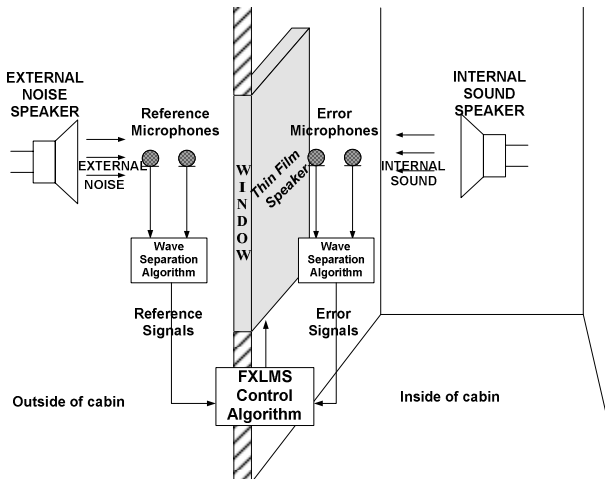

Figure 4: Set up of active noise control system with reference and error sound wave separation.

The reference and the error microphone pairs work with the wave separation algorithm to separate external noise and internal sound. Equations (1), (3), and (4) of the wave separation algorithm are used to calculate external noise or

its superposition with “anti-noise” at the reference or the error microphones. Unlike the direct measurements from microphones which are polluted by other sound in the acoustical field, the separated sound will only contain information of external noise if the wave separation algorithm works perfectly. Using the separated external sound, rather than the direct microphone measurements, for the reference and the error signals, the adverse effects caused by the “polluted” reference and error signals can be mitigated.

V. EXPERIMENTAL RESULTS OF THE WAVE SEPARATION ALGORITHM

Experiments were first done to verify that the set up of the reference and the error microphone pairs can work with the wave separation algorithm to effectively separate the external sound components for both reference and error signals. Only results on reference signal separation are presented in this paper, but similar results can also be shown for error signal separation.

For the first experiment, a 600 Hz sinusoidal audio signal was played inside the cabin, whereas no noise was generated from the noise speaker outside the cabin. This experiment simulates the scenario when the house is under no impact of external noise. The reference signals before and after wave separation started were collected and compared. It is expected that after wave separation the reference signals should contain less internal sound information (i.e. 600 Hz sinusoid) than before. Figure 5 (a) and (b) compare the reference signals before and after separation in time and frequency domain. The solid line and dashed line (or dashed line with circle markers) are the reference signal before and after wave separation respectively. The magnitude of 600 Hz sinusoid in the reference signals was reduced by more than 15 dB after the start of separation.

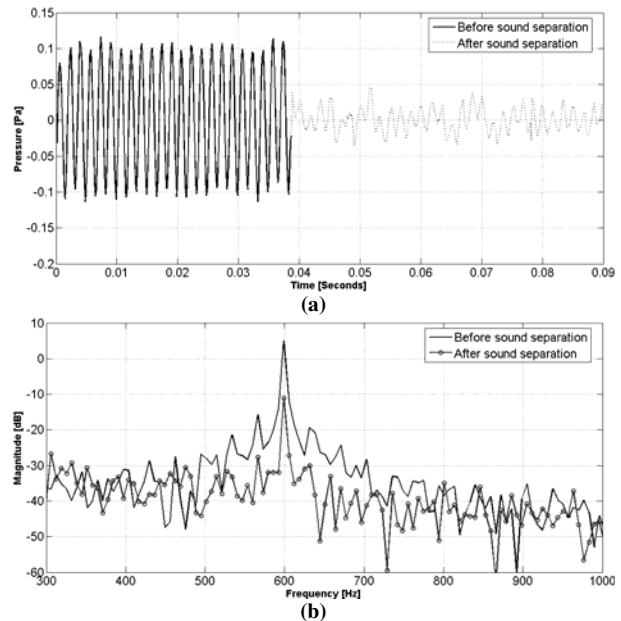

Figure 5: Wave separation algorithm eliminated internal sound (600Hz) in the reference signals; (a) reference signals before and after separation result in time domain, and (b) in frequency domain.

For the second experiment, a 600 Hz sinusoidal audio signal was played inside the cabin, and 550 Hz sinusoid was created from the external noise speaker. This experiment simulates the scenario when both external noise and internal sound exist. It is expected that external noise (550 Hz) in reference signals should be kept the same before and after the separation, whereas internal sound (600Hz) in reference signals should be eliminated by the separation. Figure 6 (a) and (b) compare the reference signals before and after separation in time and frequency domain. The solid line and dashed line (or dashed line with circle markers) are the reference signal before and after wave separation respectively. In time domain, the beat phenomenon caused by mixing 600Hz and 550Hz sound disappeared after the separation, leaving the reference signals dominated by the external noise (550Hz). In frequency domain, as seen in Fig. 6b, the magnitude of internal sound (600Hz) was reduced by almost 20dB in the reference signal after separation. The magnitude of external noise (550Hz) was slightly decreased by about 5dB because of separation, which might be due to the imperfect normal incidence of sound and the fact that the sound in the acoustical field is a three-dimensional wave instead of a one-dimensional plane wave.

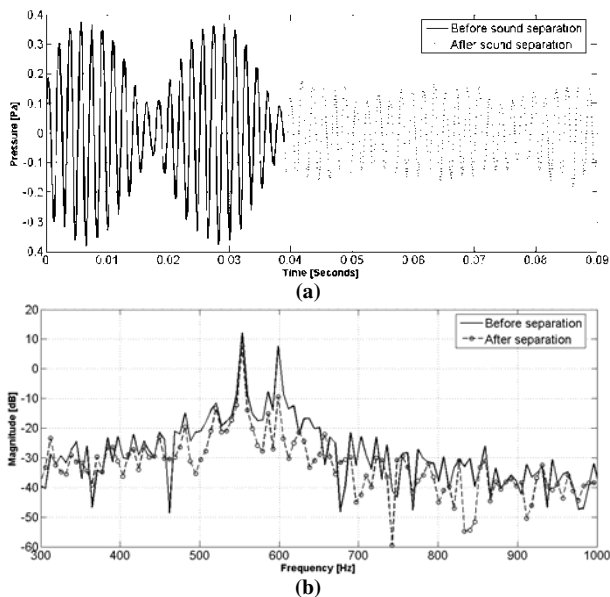

Figure 6: Wave separation algorithm eliminated internal sound (600Hz) but kept external noise (550Hz) in the reference signals; (a) reference signals before and after separation result in time domain, and (b) in frequency domain.

Since the external noise and the internal sound are usually multi-frequency, the third experiment was conducted to test the separation algorithm's effectiveness when dealing with multi-frequency signals. For this experiment, the external noise was a mix of 500Hz and 700Hz components, and the internal sound was 600Hz and 800Hz. It is expected that after the separation, the magnitude of 600Hz and 800Hz components in reference signals will be reduced, whereas the magnitude of 500Hz and 700Hz components should be kept at the same level as before the separation. Figure 7 (a) and (b) compare the reference signals before and after

separation in time and frequency domain. The solid line and dashed line (or dashed line with circle markers) are the reference signal before and after wave separation respectively. Figure 7 demonstrates that the wave separation algorithm effectively decreased the magnitude of 600Hz and 800Hz components by about 15dB, but the reduction of 500Hz and 700Hz external noise was less than 5dB.

Experiments in the three scenarios verify that the wave separation algorithm can effectively separate external noise from the direct microphone measurements. This can help to reduce the adverse effects on ANC introduced by the "polluted" reference and error signals. The separation algorithm did also decrease the external noise in reference signals by a few decibels in all three experiments. However, the reduction was insignificant compared to the decrease of internal sound.

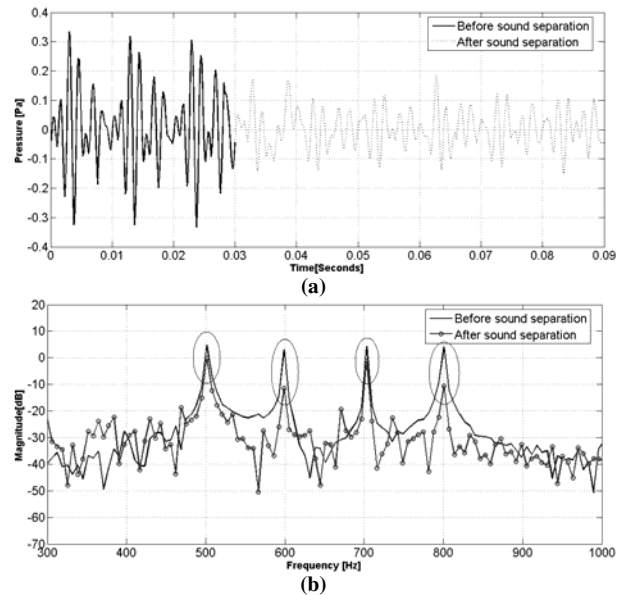

Figure 7: Wave separation algorithm eliminated internal sound (600Hz and 800Hz) but preserved external noise (500Hz and 700Hz) in the reference signals; (a) reference signals before and after separation result in time domain, and (b) in frequency domain.

VI. EXPERIMENTAL RESULTS OF THE ANC SYSTEM INTEGRATED WITH THE WAVE SEPARATION ALGORITHM

To verify the effectiveness of the ANC system when integrated with the wave separation algorithm, another three experiments were performed. For the first experiment, 600Hz sinusoid was played inside the cabin, whereas no noise was generated from the noise speaker outside the cabin. This experiment simulates the scenario when the house is under no impact of external noise. Figure 8 (a) is the noise control result in frequency domain from ANC system without wave separation: the solid line and the solid line with circle markers are the sound in cabin before and after the noise control started respectively. As shown in Figure 8 (a), without wave separation, the ANC system suppressed the desired internal sound (600Hz) by a significant amount of 40dB. Figure 8 (b) is the noise control results in frequency domain from ANC system with wave separation. The desired internal sound (600Hz) was well

preserved after the noise control started. Figure 8 (c) shows the control signals generated by the ANC algorithm with and without wave separation: with wave separation much less control effort (~20dB less) was exerted to cancel the desired internal sound (600Hz) than without wave separation.

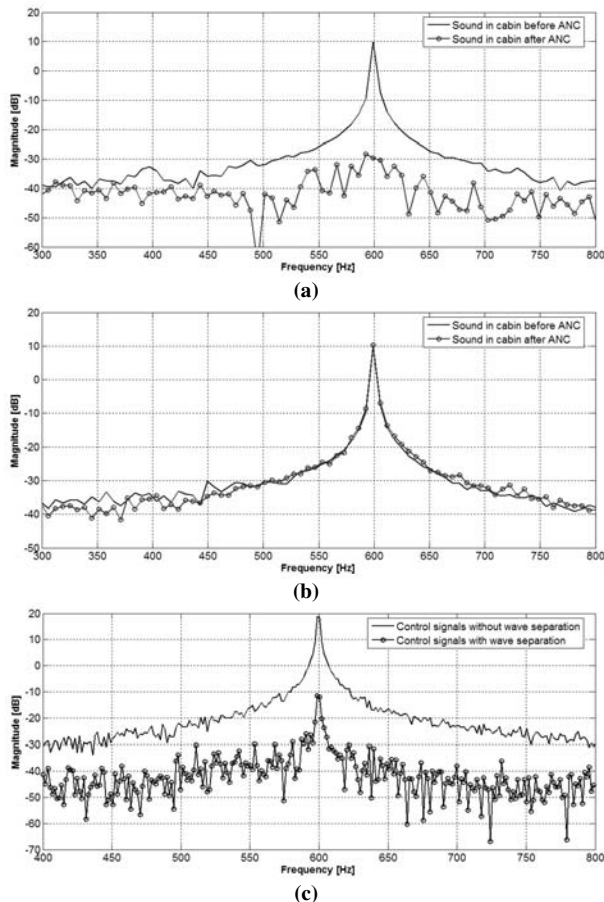

Figure 8: Control outcome of the ANC systems without and with the wave separation, when internal sound is 600Hz and external noise is mute; (a) without separation the desired internal sound was cancelled; (b) with separation the desired internal sound was well preserved. (c) Control signals with and without wave separation.

For the second experiment, 600 Hz sinusoid was played inside the cabin, and 550 Hz sinusoid was created from the external noise speaker. Figure 9 (a) and (b) are the noise control results in frequency domain from ANC systems without and with wave separation respectively. Without separation, both the undesired external noise and desired internal sound were significantly cancelled. Whereas with separation, only external noise was greatly reduced, the internal sound was hardly decreased but well preserved. Figure 9 (c) shows the control signals generated by the ANC algorithm with and without wave separation. With wave separation, much less control effort was exerted to cancel the desired internal sound (600Hz) than without wave separation, whereas control effort to cancel unwanted external noise was not weakened with wave separation.

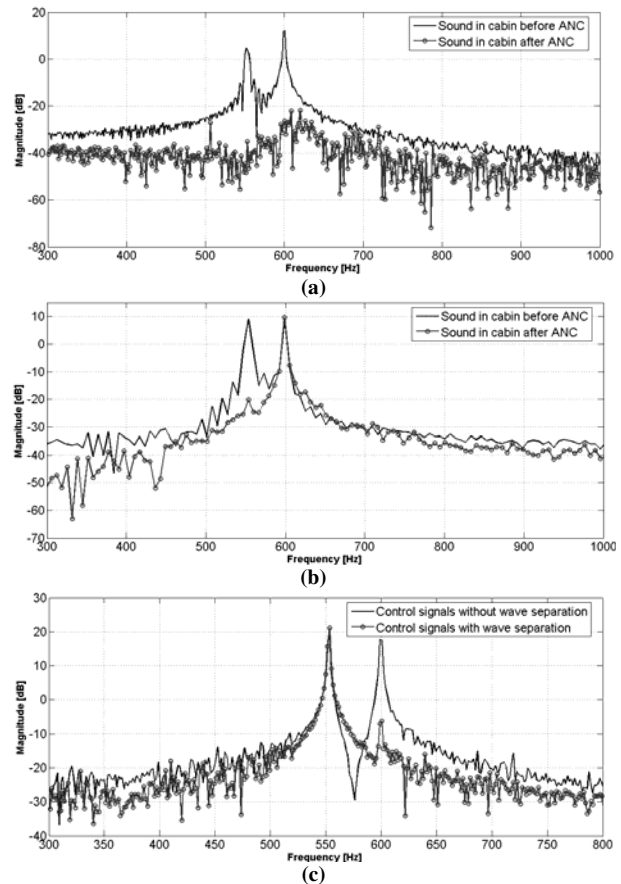

Figure 9: Control outcome of the ANC systems without and with the wave separation, when internal sound was 600Hz and external noise was 550Hz; (a) without separation the desired internal sound was cancelled; (b) with separation the desired internal sound was well preserved; (c) control signals with and without wave separation.

For the third experiment, external noise is a mix of 550Hz and 700Hz sinusoids, and internal sound is a mix of 600Hz and 850Hz sinusoids. This experiment was conducted to test the effectiveness of ANC system when handling multi-frequency external noise and internal sound. Figure 10 (a) and (b) are the noise control results in frequency domain from ANC systems without and with wave separation respectively. Figure 10 (c) shows the control signals generated by both systems. Same as the second test: without separation, both external noise and internal sound were cancelled, whereas with separation the ANC system can effectively cancel external noise but leave the desired internal sound untouched. This difference is again due to the result of different control efforts exerted on external noise and internal sound by the ANC systems with and without separation.

Results from the experiments demonstrated the effectiveness of the ANC system with wave separation when dealing with both single frequency and multi-frequency internal sound. With the wave separation's ability to obtain "unpolluted" reference and error signals, much less control effort was exerted to cancel internal sound than without wave separation. On the other hand, the ANC system's ability to cancel external noise entering the cabin was not significantly degenerated because of the wave separation.

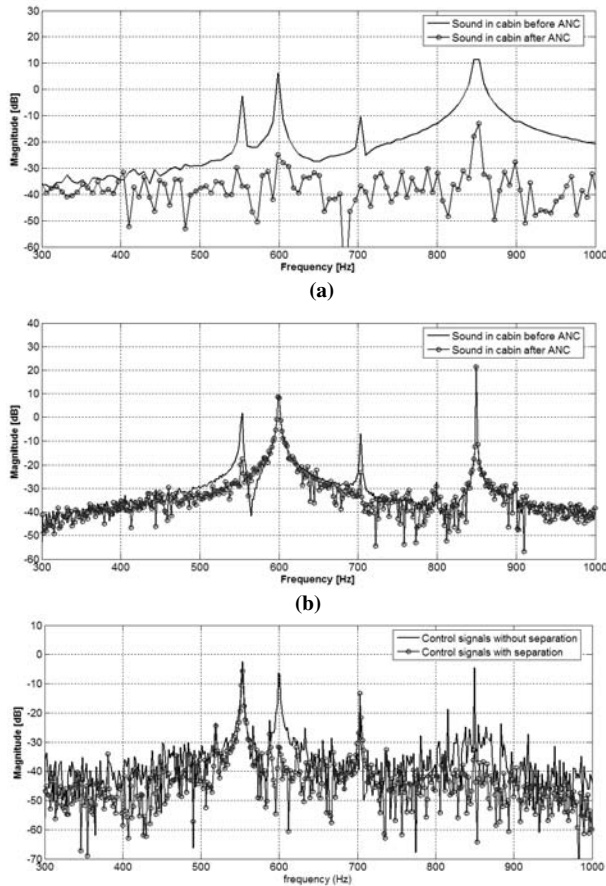

Figure 10: Control outcome of the ANC systems with the wave separation, when internal sound was multi-frequency (600 and 850 Hz) and external noise was 550 and 700 Hz (a) without separation all sound (internal or external) was eliminated; (b) with separation internal sound (600 and 850 Hz) was preserved while external noise (550 and 700 Hz) was eliminated; (c) control signals produced by the ANC with and without wave separation.

VII. CONCLUSIONS

This paper proposed to integrate the FXLMS feedforward ANC system with a wave separation algorithm, which separates external sound from other sound in the environment. The resulting new ANC system used the separated external sound from wave separation for reference and error signals instead of direct microphone measurements. In this way, adverse effects caused by the “polluted” reference and error signals can be mitigated. The performance of the new ANC system was experimentally tested with a cabin equipped with a window which simulated a real room. As shown in the experimental results, the most obvious improvement over the ANC system without wave separation is that the control effort exerted to cancel internal sound can be reduced and the internal sound can be better preserved. The wave separation algorithm was developed based on assumption of one-dimensional plane wave sound transmission. The algorithm needs modification to extend its use for a more complex three-dimensional sound wave environment. The separation algorithm also assumes normal incidence of sound to the microphones. For slightly oblique sound incidence the wave separation results are still

satisfactory, as shown in our experiments on wave separation. Since only the normal component of noise is largely transmitted through the window while the shear or orthogonal component is absorbed, the ANC system integrated with the wave separation algorithm is still of practical use, even in a situation of oblique sound incidence.

REFERENCES

- [1] Keast, D.N., “Energy Conservation and Noise Control in Residences”, *Sound and Vibration*, Vol. 13, No.7, pp. 18-22, July, 1979.
- [2] W. A. Utley, I. B. Buller, E. C. Keighley, J. W. Sargent, “Effectiveness and acceptability of measures for insulating dwellings against traffic noise,” *Journal of Sound and Vibration*, Vol. 109, Issue 1, pp. 1-18, August, 1986.
- [3] S.M. Kuo, and D.R. Morgan, “Active noise control systems – Algorithms and DSP implementations”, Wiley, New York, 1996.
- [4] C. Deffayet and P.A. Nelson, “Active Control of Low-frequency Harmonic Sound Radiated by A Finite Panel,” *Journal of Acoustic Society of America*, Vol. 84 (6), pp.2192-2199.
- [5] S.J. Elliott, P.A. Nelson, I.M. Stothers, and C.C. Boucher, “In-Flight Experiments on the Active Control of Propeller-Induced Carbin Noise,” *Journal of Sound and Vibration*, Vol. 140 (2), pp.219-238.
- [6] P. Sas, C. Bao, F. Augusztnovicz, and W. Desmet, “Active Control of Sound Transmission Through a Double Panel Partition”, *Journal of Sound and Vibration*, Vol. 180 (4), pp. 609-625, 1995.
- [7] P.D. Fonseca, W. Desmet, A. Cops, J. Cooper, and P. Sas, “Active Control of the Sound Transmission Through a Double-glazing Window,” *Inter-noise 96*, pp. 1811-1816, 1996.
- [8] A. Jakob and M. Moser, “Enhancement of the Transmission Loss of Double Panels by Means of Actively Controlling the Cavity Sound Field,” *ACTIVE 99*, pp. 363-374, 1999.
- [9] C.R. Fuller, C.H. Hansen, and S.D. Snyder, “Experiments on Active Control of Sound Radiation from a Panel using a Piezoceramic Actuator,” *Journal of Sound and Vibration*, Vol. 150 (2), pp. 179-190, 1991.
- [10] R.L. Clark and C.R. Fuller, “Experiments on Active Control of Structurally Radiated Sound using Multiple Piezoceramic Actuators,” *Journal of Acoustic Society of America*, Vol. 91(6), pp.3313-3320.
- [11] X.Yu, R.Rajamani, K.A. Stelson, and T.Cui, “Active Control of Sound Transmission Through Windows with Carbon Nanotube Based Transparent Actuators,” *IEEE Transactions on Control Systems and Technology*, Vol. 15, No. 4, pp.704-714, July, 2007.
- [12] S. Haykin, “Adaptive Filter Theory”, Third edition, Prentice Hall, Englewood Cliffs, NJ, 1995.
- [13] H. Zhu, R.Rajamani, and K.A. Stelson, “Active control of acoustic reflection, absorption and transmission using thin panel speakers,” *Journal of Acoustic Society of America*, Vol. 113, No. 2, February, 2007.
- [14] Z.C. Qiu, X.M. Zhang, H.X. Wu, and H.H. Zhang, “Optimal Placement and Active Vibration Control for Piezoelectric Smart Flexible Cantilever Plate,” *Journal of Sound and Vibration*, Vol. 301, No. 3-5, pp. 521-543, April 2007.
- [15] M.A. Bassyiouni and B. Balachandran, “Sound Transmission Through a Flexible Panel into an Enclosure: Structural Acoustics Model,” *Journal of Sound and Vibration*, Vol. 284, No. 1-2, pp. 467-486, June 2005.