

# Super-heater Control Based On Feedback Linearization

Wiktor Bolek, Jerzy Sasiadek, *Senior Member, IEEE*

**Abstract** — Steam parameters control problem in power plants with coal fired boilers is one of the most challenging problems. The steam parameters are extreme at the boiler outlet. The large time constants and nonlinearities are involved in the process model. In this paper, it was shown that the feedback linearization method can be applied to synthesise control system for this process. The derivation of the linearizing transformation is not an easy task. It requires symbolic solutions for ordinary differential equations. The proposed method was compared with PI and proportional state feedback control algorithms. Simulation experiments were carried out in different points of operation, with different heat distribution and in presence of unmodelled dynamics.

## I. INTRODUCTION

IN the coal fired power plant stations, steam delivered to a turbine is produced in the boiler. The last stage of steam processing is the superheating process. In order to achieve highest efficiency, the steam temperature must be as high as possible. On the other hand, the creep-resistance of the superheater tubes must not be exceeded. It makes the steam temperature control one of the most challenging problems.

The steam temperature is controlled by systems, in which, cooling water is added before the superheater. The control variable is a water flow. The control is achieved through mixing steam and water in a device called an attemperator. Due to the energy balance, the gain coefficient of the attemperation process depends on boiler load (steam flow). It makes the process non-linear. The other difficulty is that the heat exchange in the superheater tubes is relatively slow, and therefore, time constants associated with this process are quite large.

The classical approach to superheater control is an application of the cascade PI controllers in various

configurations. An overview of these control systems was presented in [5]. An adaptive gain controller was presented in [1]. A MIMO system with a linear model based controller for a drum type coal fired boiler was presented in [2]. An adaptive optimal control was applied in [7]. State space controller and non-linear model based control was presented in [8].

The main drawback of these attitudes is that the process non-linearities are not treated in the same manner over the whole range of boiler's loads. The feedback linearization techniques gives better results, as it transforms non-linear model of the process to the linear one in the whole range of operation. Moreover, this technique allows dealing with unmeasured disturbances [4], [6].

## II. PROCESS MODEL

The diagram of the last stage superheater and its attemperator is depicted in Fig. 1. There are three points, where the steam temperature is measured: before, and behind the attemperator, and at the outlet of the boiler. If, the pressure distribution along superheater tubes is known, then the steam characteristic enthalpies  $h_0$ ,  $h_1$ ,  $h_3$  can be measured. On the basis of other measurements available in the boiler, the injection water enthalpy  $h_w$  and steam flow  $m_0$  are also known.

Steam and water are mixed together in the attemperator's chamber. This process is relatively fast. It is modelled by static energy balance, which leads to equation (1). The injection water flow is a control variable. It is denoted by  $u$ .

$$h_0 m_0 + h_w u = h_1 (m_0 + u) \quad (1)$$

The heat exchange in the superheater is modelled using a partial differential equation. Based on Profos transfer function and Hanus approximation [10], the superheater may be divided into several sections. The thermodynamics process in every section is described by ordinary differential equations. In these equations, an unmeasured disturbance - heat flow, plays a crucial role. The heat flow is responsible for the temperature increase to its nominal value. There is some latitude in the number of sections selection process. In this paper, a superheater that can be divided into two sections (nodes) is considered (Fig. 2). In this case, the feedback

Manuscript received September 25, 2003.

W. Bolek is with the Wrocław University of Technology, Institute of Thermal Engineering and Fluid Mechanics, ul. Wybrzeże Wyspińskiego 27, Wrocław, 50-370 Poland (phone: +48 71 3203880; fax: +48 71 3283818; e-mail: wbolek@pwr.wroc.pl).

J. Sasiadek, is with Carleton University, 1125 Colonel By Drive, Ottawa, Ontario, K1S 5B6 CANADA (e-mail: jsas@ccs.carleton.ca).

linearization problem is solvable. The heat flow is divided into two sections (nodes), respectively.

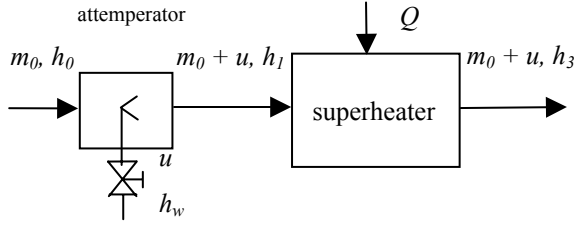

Fig. 1 Physical process in the superheater.

$$Q = 2Q_n + \Delta Q \quad (2)$$

$$2Q_n = m_0(h_n - h_0) \quad (3)$$

$$\Delta Q = (-h_3 + h_w)\Delta q = (-h_3 + h_2)\Delta q + (-h_3 + h_2)\Delta q \quad (4)$$

Let's denote:  $\Delta Q_1 = (-h_3 + h_2)\Delta q$   
 $\Delta Q_2 = (-h_2 + h_w)\Delta q$

$2Q_n$  - is the nominal heat flow, which increases the enthalpy of the steam  $m_0$  from the original value  $h_0$  to its nominal value  $h_n$ . Therefore,  $Q_n$ , can be treated as a known quantity (3) and it is divided by half for each node. The remaining part  $\Delta Q$  of heat flow is considered as an unknown disturbance, and it is a split between two nodes according to the enthalpy differences (4). These partial, unknown heat flows are denoted  $\Delta Q_1$  and  $\Delta Q_2$  respectively. In actual process, this split may be different and the developed control algorithm will be tested for the robustness accordingly to this splitting. This assumption enables to derive linearizing transformations and leads to process model (5).

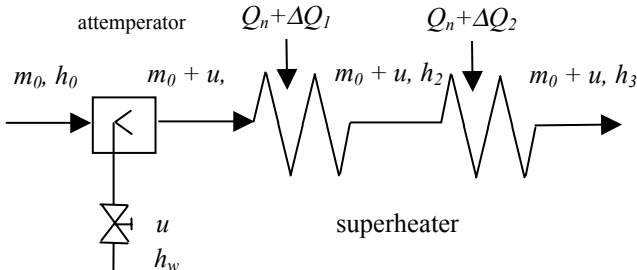

Fig. 2. Two nodes of the super-heater.

$$T\dot{h}_3 = (-h_3 + h_2)m_0 + Q_n + (-h_3 + h_2)u + (-h_3 + h_2)\Delta q \quad (5)$$

$$T\dot{h}_2 = (-h_2 + h_0)m_0 + Q_n + (-h_2 + h_w)u + (-h_2 + h_w)\Delta q$$

$T$  is the time constant of the node, its value can be calculated based on Profos and Hanus approximation and the geometric and material properties of the superheater tubes.

The enthalpies  $h_3$ ,  $h_2$  are chosen as state variables  $x_1$ ,  $x_2$ . The equations (5) can be rewritten in a standard state space

form (6).

$$\dot{\mathbf{x}} = \mathbf{f}(\mathbf{x}) + \mathbf{g}(\mathbf{x}) \cdot (u + \Delta q) \quad (6)$$

$$\text{where, } \mathbf{x} = \begin{bmatrix} x_1 \\ x_2 \end{bmatrix} = \begin{bmatrix} h_3 \\ h_2 \end{bmatrix}, \quad \mathbf{f}(\mathbf{x}) = \frac{1}{T} \begin{bmatrix} (-x_1 + x_2)m_0 + Q_n \\ (-x_2 + h_0)m_0 + Q_n \end{bmatrix},$$

$$\mathbf{g}(\mathbf{x}) = \frac{1}{T} \begin{bmatrix} -x_1 + x_2 \\ -x_2 + h_w \end{bmatrix}.$$

The equilibrium point for this system (without unknown disturbances and control) is

$$x_{1e} = h_1 + 2\frac{Q_n}{m_0}; \quad x_{2e} = h_1 + \frac{Q_n}{m_0}.$$

### III. THE APPLICATION OF FEEDBACK LINEARIZATION

The application of feedback linearization requires some knowledge of differential geometry, which may be found in the mentioned already books [4], [6]. Plant (6) fulfils conditions of feedback linearizability [9]. However, in order to find linearizing transformation, one has to solve for  $\lambda$  two partial differential equations (7).

$$\frac{\partial \lambda}{\partial x_1}(-x_1 + x_2) = 0, \quad \frac{\partial \lambda}{\partial x_2}(-x_2 + h_0) = 0 \quad (7)$$

These equations are solved by method of characteristics [3]. In this case, solution is obtained based on symbolic computations.

$$\lambda(\mathbf{x}) = -\frac{T(x_2 - h_w)}{m_0(h_0 - h_w) + Q_n} \cdot e^{\frac{m_0(h_0 - h_w)(x_2 - h_w) + T(m_0(h_0 - h_w) + Q_n)(x_1 - h_w)}{T(m_0(h_0 - h_w) + Q_n)(x_2 - h_w)}} \quad (8)$$

The linearizing transformation of states and controls are given by standard relations (9), (10). Since consecutive Lie derivatives form long expressions, they are not shown here in the fully developed form.

$$\mathbf{z} = \begin{bmatrix} z_1 \\ z_2 \end{bmatrix} = \mathbf{T}(\mathbf{x}) = \begin{bmatrix} \lambda(\mathbf{x}) \\ L_f \lambda(\mathbf{x}) \end{bmatrix} \quad (9)$$

$$u = u(\mathbf{x}, v) = \frac{1}{L_g L_f \lambda(\mathbf{x})} (v - L_f^2 \lambda(\mathbf{x})) \quad (10)$$

$v$  - new control signal.

The system in new co-ordinates assumes the form (11).

$$\begin{bmatrix} \dot{z}_1 \\ \dot{z}_2 \end{bmatrix} = \begin{bmatrix} 0 & 1 \\ 0 & 0 \end{bmatrix} \begin{bmatrix} z_1 \\ z_2 \end{bmatrix} + \begin{bmatrix} 0 \\ 1 \end{bmatrix} v + \begin{bmatrix} 0 \\ 1 \end{bmatrix} \Delta \bar{q} \quad (11)$$

where,  $\Delta \bar{q} = \Delta q \cdot L_g L_f z_1$  is a new disturbance.

An integral action (state variable  $z_3$ ) has to be introduced in order to counteract unknown disturbance  $\Delta Q$  with a non-zero mean. The desired outlet steam temperature is equal to  $\vartheta_{3 \text{ des}} = 540, ^\circ\text{C}$ . The respective enthalpy (state variable) is equal to  $x_{1 \text{ des}} = 3389, \text{kJ/kg}$ , which enables to compute desired value of new variable  $z_{1 \text{ des}}$ . The linearized system with integral action has the form (12).

$$\begin{bmatrix} \dot{z}_1 \\ \dot{z}_2 \\ \dot{z}_3 \end{bmatrix} = \begin{bmatrix} 0 & 1 & 0 \\ 0 & 0 & 0 \\ 1 & 0 & 0 \end{bmatrix} \begin{bmatrix} z_1 \\ z_2 \\ z_3 \end{bmatrix} + \begin{bmatrix} 0 \\ 1 \\ 0 \end{bmatrix} v + \begin{bmatrix} 0 \\ 1 \\ 0 \end{bmatrix} \Delta \bar{q} - \begin{bmatrix} 0 \\ 0 \\ z_{1 \text{ des}} \end{bmatrix} \quad (12)$$

#### IV. SIMULATIONS

The control system based on feedback linearization was compared with two classical controllers: PI and proportional state feedback (p.s.f.) with integral action. The block diagram of control system based on linearization is depicted in Fig. 3. In the simulations carried out in this paper, the control systems were excited by a step change of additional heat flow  $\Delta Q$ , which was equal to  $2000 \text{ kW}$ . This flow was divided equally between both nodes – contrary to the assumption made during control synthesis process. *Experiments 5* and *6* were carried out with an uneven heat distribution in order to justify robustness of control system accordingly to this phenomenon.

The dynamics of an actuator, which runs the injection water valve, was modelled by first order inertia. Its dynamics was not taken into account during control synthesis. The control algorithm requires state variable  $x_2$  (enthalpy  $h_2$ ), which is not available by measurement. An observer was designed to estimate it (Fig. 4). The observer reconstructs the state  $\hat{x}_2$ . The control system with proportional state feedback makes use of the same observer.

Nominal conditions of superheater operation:

$p_0 = 18.0, \text{MPa}$  – steam pressure at the inlet of attemperator,  
 $\vartheta_0 = 499, ^\circ\text{C}$  – steam temperature at the inlet of attemperator,  
 $h_0 = 3267, \text{kJ/kg}$  – steam specific enthalpy pressure at the inlet of attemperator,  
 $p_3 = 17.8, \text{MPa}$  – steam pressure at the outlet of superheater,  
 $\vartheta_3 = 540, ^\circ\text{C}$  – steam temperature at the outlet of superheater,  
 $h_3 = 3389, \text{kJ/kg}$  – steam specific enthalpy pressure at the outlet of superheater,  
 $m_0 = 77.7, \text{kg/s}$  ( $280 \text{t/h}$ ) – steam mass flow to the attemperator,  
 $h_w = 1500, \text{kJ/kg}$  – specific enthalpy of injection water,  
 $Q_n = 4666, \text{kW}$  – nominal heat flow transferred to a single node,  
 $T = 4200, \text{s}$  – time constant of the node,  
 $T_a = 1, \text{s}$  – time constant of an actuator.

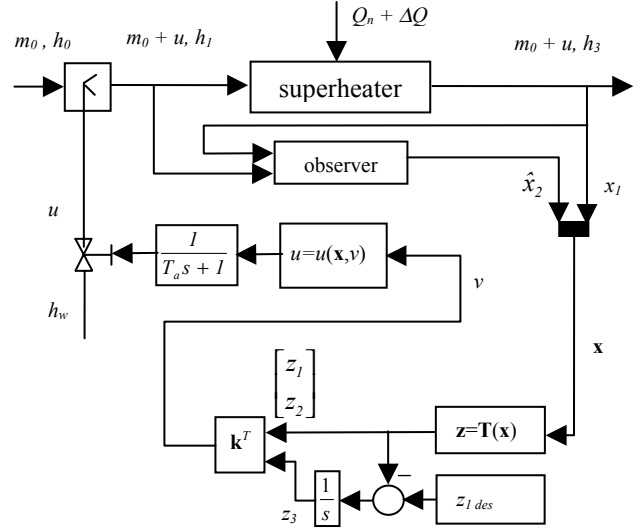

Fig. 3. Control system structure.

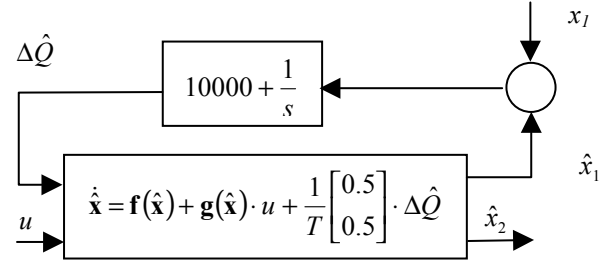

Fig. 4. Structure of the observer.

During the tuning process of the control system for a superheater one has to take into account outlet steam temperature deviations and work performed by the actuator. The control systems under consideration were tuned-up in order to achieve the same overshoot of the control signal in nominal conditions.

The control systems will be compared accordingly to the control effort done by the actuator. This effort will be assessed based on two parameters: the overshoot of control signal and the maximum speed of the actuator during transient period. The heat disturbance  $\Delta Q$  is the same in all experiments. It means that steady state value of the control (injected water flow) is the same. One has to inject so much water  $u_{\text{stead}}$ , that the  $\Delta Q$  will rise its enthalpy to the desired value  $h_3 = 3389, \text{kJ/kg}$  (13).

$$u_{\text{stead}} = \frac{\Delta Q}{h_3 - h_w} = 1.06, \text{kg/s} \quad (13)$$

If the actuator moves faster during transient process, then friction increases, which causes faster wear of the mechanical parts of actuator-valve system. Therefore, the maximum of control signal derivative describes the wear out of this system.

**Experiment 1**  
Nominal conditions

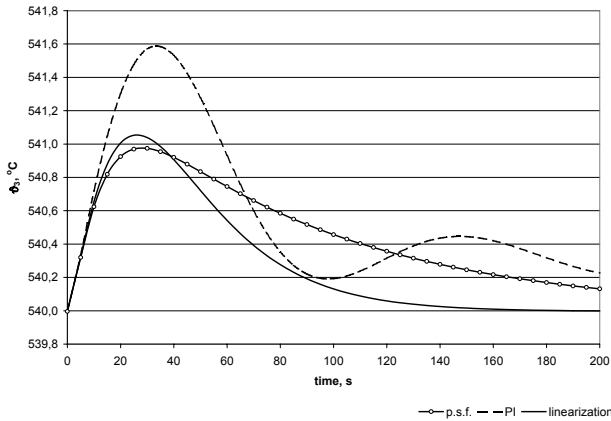

Fig. 5. Transients of the outlet temperature  $\vartheta_3$  in the nominal conditions,  $h_0 = 3267, \text{ kJ/kg}$ , ( $\vartheta_0 = 499, ^\circ\text{C}$ );  $m_0 = 77, \text{ kg/s}$ ;  $\Delta Q = 2000 \text{ kW}$  - equally distributed on both nodes.

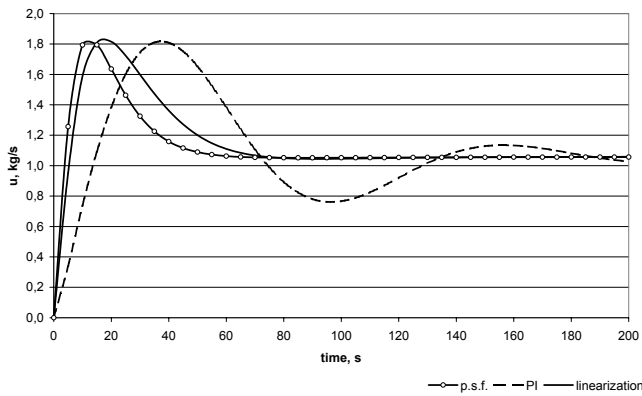

Fig. 6. Transients of the control signal  $u$  in the nominal conditions,  $h_0 = 3267, \text{ kJ/kg}$ , ( $\vartheta_0 = 499, ^\circ\text{C}$ );  $m_0 = 77, \text{ kg/s}$ ;  $\Delta Q = 2000 \text{ kW}$  - equally distributed on both nodes.

**Experiment 2.**  
Steam flow lower than in nominal conditions.

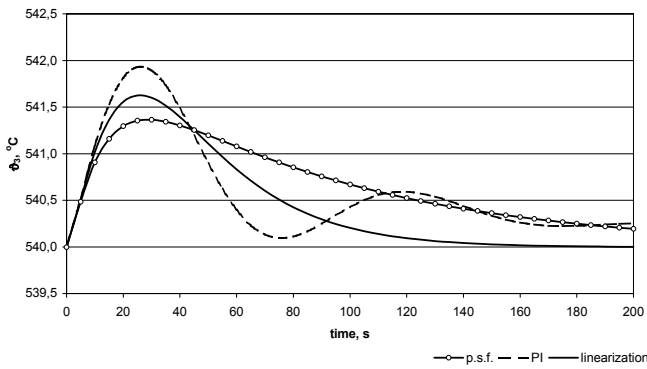

Fig. 7. Transients of the outlet temperature  $\vartheta_3$  in conditions :  $h_0 = 3267, \text{ kJ/kg}$ , ( $\vartheta_0 = 499, ^\circ\text{C}$ );  $m_0 = 50, \text{ kg/s}$ ;  $\Delta Q = 2000 \text{ kW}$  - equally distributed on both nodes.

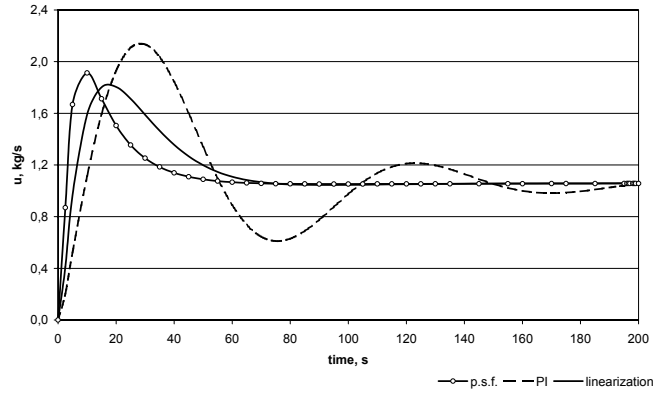

Fig. 8. Transients of the control signal  $u$  in conditions :  $h_0 = 3267, \text{ kJ/kg}$ , ( $\vartheta_0 = 499, ^\circ\text{C}$ );  $m_0 = 50, \text{ kg/s}$ ;  $\Delta Q = 2000 \text{ kW}$  - equally distributed on both nodes.

**Experiment 3.**  
Steam flow and inlet steam enthalpy lower than in nominal conditions.

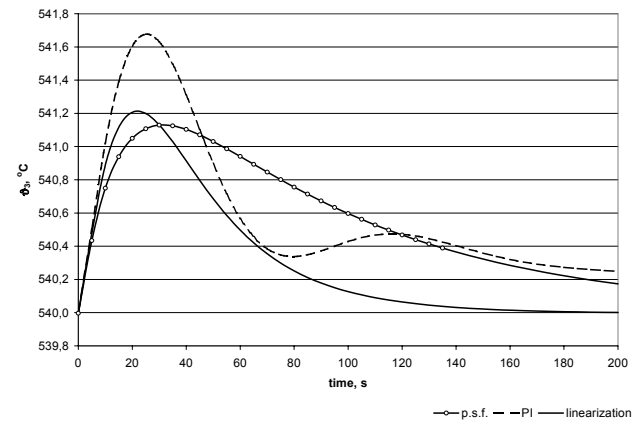

Fig. 9. Transients of the outlet temperature  $\vartheta_3$  in conditions :  $h_0 = 3000, \text{ kJ/kg}$ , ( $\vartheta_0 = 424, ^\circ\text{C}$ );  $m_0 = 50, \text{ kg/s}$ ;  $\Delta Q = 2000 \text{ kW}$  - equally distributed on both nodes.

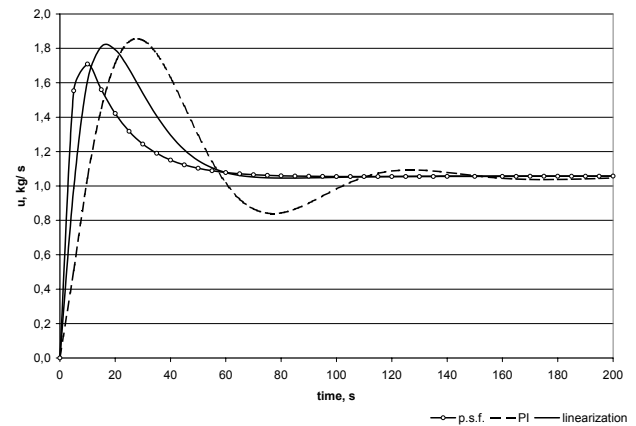

Fig. 10. Transients of the control signal  $u$  in conditions :  $h_0 = 3000, \text{ kJ/kg}$ , ( $\vartheta_0 = 424, ^\circ\text{C}$ );  $m_0 = 50, \text{ kg/s}$ ;  $\Delta Q = 2000 \text{ kW}$  - equally distributed on both nodes.

**Experiment 4.**

Steam flow and inlet steam enthalpy **higher** than in nominal conditions.

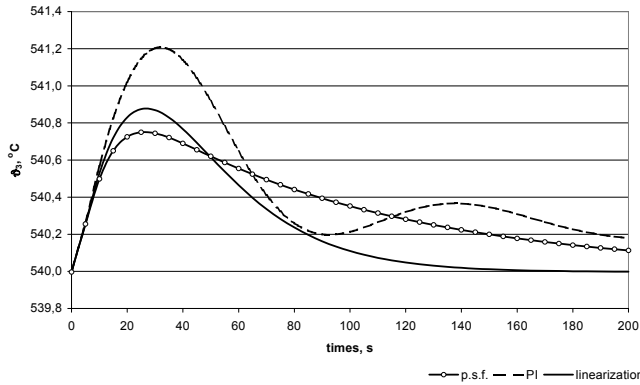

Fig. 11. Transients of the outlet temperature  $\vartheta_3$  in conditions :  $h_0 = 3300$ ,  $kJ/kg$ , ( $\vartheta_0 = 510$ ,  $^\circ C$ );  $m_0 = 88$ ,  $kg/s$ ;  $\Delta Q = 2000$   $kW$  - equally distributed on both nodes.

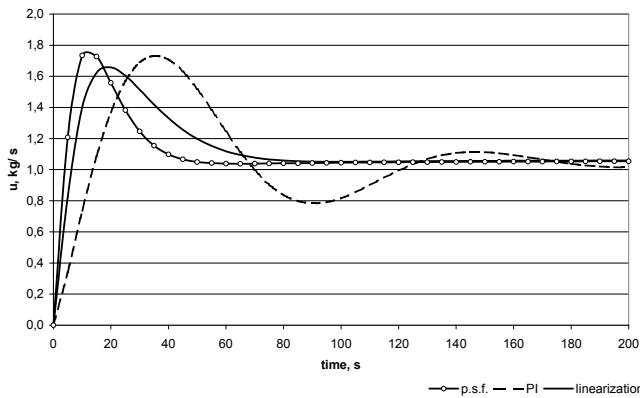

Fig. 12. Transients of the control signal  $u$  in conditions :  $h_0 = 3300$ ,  $kJ/kg$ , ( $\vartheta_0 = 510$ ,  $^\circ C$ );  $m_0 = 88$ ,  $kg/s$ ;  $\Delta Q = 2000$   $kW$  - equally distributed on both nodes.

**Experiment 5.**

Nominal conditions, but uneven heat distribution. More heat to the **second** node.

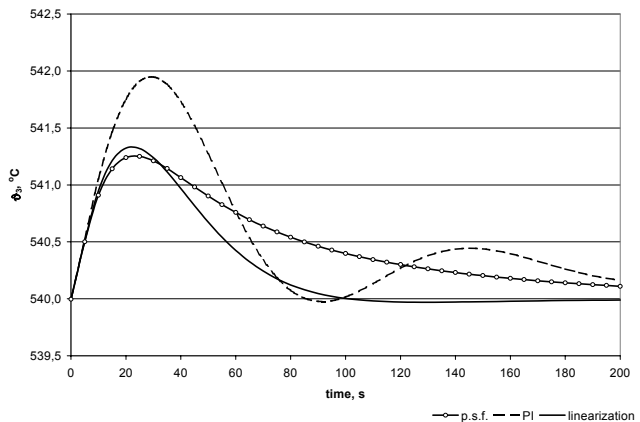

Fig. 13. Transients of the outlet temperature  $\vartheta_3$  in the nominal conditions,  $h_0 = 3267$ ,  $kJ/kg$ , ( $\vartheta_0 = 499$ ,  $^\circ C$ );  $m_0 = 77$ ,  $kg/s$ ;  $\Delta Q = 2000$   $kW$  - 45% of  $\Delta Q$  delivered to the first node, 55% of  $\Delta Q$  delivered to the second node.

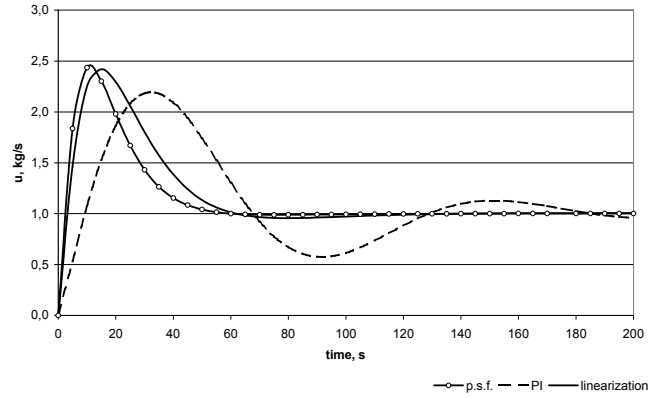

Fig. 14. Transients of the control signal  $u$  in the nominal conditions,  $h_0 = 3267$ ,  $kJ/kg$ , ( $\vartheta_0 = 499$ ,  $^\circ C$ );  $m_0 = 77$ ,  $kg/s$ ;  $\Delta Q = 2000$   $kW$  - 45% of  $\Delta Q$  delivered to the first node, 55% of  $\Delta Q$  delivered to the second node.

**Experiment 6.**

Nominal conditions, but uneven heat distribution. More heat to the **first** node.

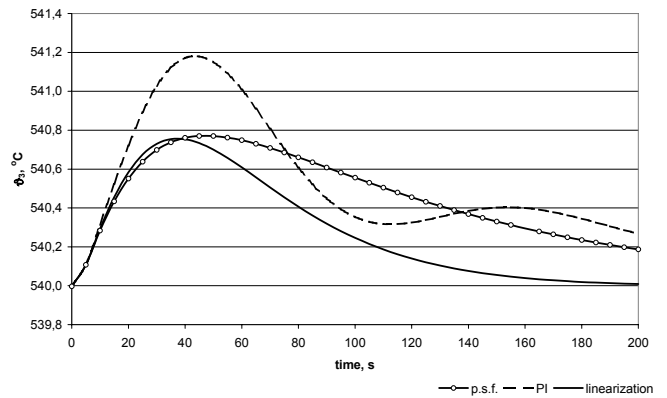

Fig. 15. Transients of the outlet temperature  $\vartheta_3$  in the nominal conditions,  $h_0 = 3267$ ,  $kJ/kg$ , ( $\vartheta_0 = 499$ ,  $^\circ C$ );  $m_0 = 77$ ,  $kg/s$ ;  $\Delta Q = 2000$   $kW$  - 55% of  $\Delta Q$  delivered to the first node, 45% of  $\Delta Q$  delivered to the second node.

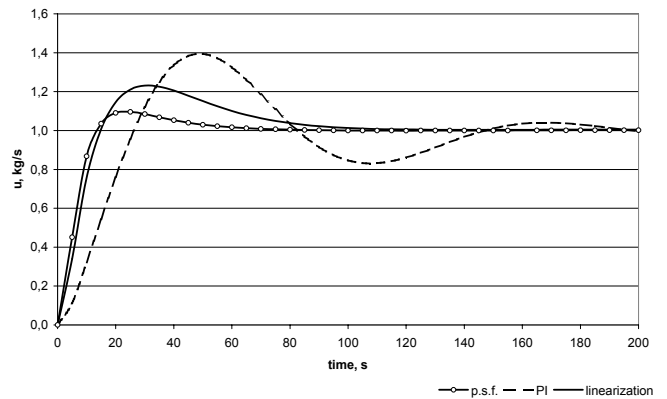

Fig. 16. Transients of the control signal  $u$  in the nominal conditions,  $h_0 = 3267$ ,  $kJ/kg$ , ( $\vartheta_0 = 499$ ,  $^\circ C$ );  $m_0 = 77$ ,  $kg/s$ ;  $\Delta Q = 2000$   $kW$  - 55% of  $\Delta Q$  delivered to the first node, 45% of  $\Delta Q$  delivered to the second node.

### Experiment 7.

Nominal conditions, but increased time constant of unmodelled dynamics of actuator.

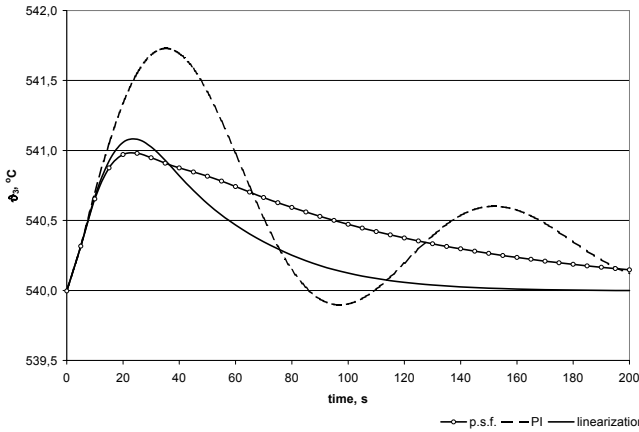

Fig. 17. Transients of the outlet temperature  $\vartheta_s$  in the nominal conditions,  $h_0 = 3267$ , kJ/kg, ( $\vartheta_0 = 499$ , °C);  $m_0 = 77$ , kg/s;  $\Delta Q = 2000$  kW ; time constant of actuator's unmodelled dynamics was increased to  $T_a = 5$ , s.

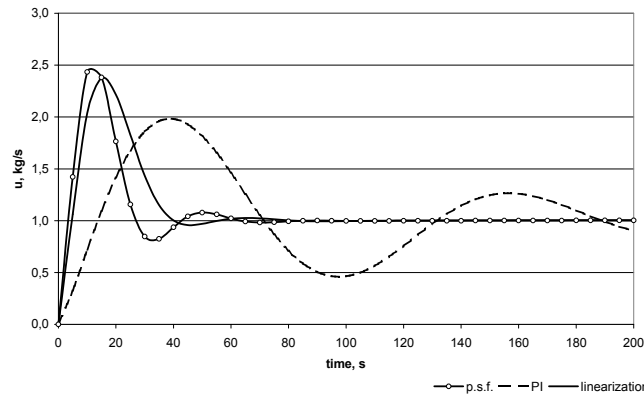

Fig. 18. Transients of the control signal  $u$  in the nominal conditions,  $h_0 = 3267$ , kJ/kg, ( $\vartheta_0 = 499$ , °C);  $m_0 = 77$ , kg/s;  $\Delta Q = 2000$  kW ; time constant of actuator's unmodelled dynamics was increased to  $T_a = 5$ , s.

Table 1. Parameters of control signal transients.

		p. s. f.	PI	Lineariz.
Exp. 1	$e_d$	1,83	1,82	1,83
	$(du/dt)_{\max}$	0,38	0,08	0,26
Exp. 2	$e_d$	1,93	2,14	1,82
	$(du/dt)_{\max}$	0,48	0,12	0,28
Exp. 3	$e_d$	1,73	1,86	1,82
	$(du/dt)_{\max}$	0,48	0,12	0,28
Exp. 4	$e_d$	1,73	1,73	1,66
	$(du/dt)_{\max}$	0,28	0,06	0,18
Exp. 5	$e_d$	2,44	2,18	2,42
	$(du/dt)_{\max}$	0,36	0,10	0,29
Exp. 6	$e_d$	1,10	1,39	1,23
	$(du/dt)_{\max}$	0,09	0,02	0,06
Exp. 7	$e_d$	2,43	1,98	2,37
	$(du/dt)_{\max}$	0,28	0,06	0,20

In all experiments, control system based on feedback linearization performed with a lower maximum speed of control signal than proportional feedback control system. The control quality of these two systems was the same in the terms of temperature overshoot, but the settling time was shorter in linearization case. The PI control system had the lowest maximum speed of control signal, but its control quality was the worst.

## V. CONCLUSION

It is possible to find linearizing transformations for the superheater - attemperator system. Derivation of these transformations is not an easy task – it requires symbolic manipulation solving procedure for differential equations. This procedure works well, because the superheater is divided into two nodes.

The performed simulations are show that the concept is viable and valid. The control system with feedback linearization performed well in the boiler's whole range of operation with the lowest usage of actuator, while preserving required temperature transients. This feature is important from the boiler's operator point of view. It means that the actuator-valve system will require maintenance less frequently.. The control system was robust to changes in heat distribution and presence of unmodelled dynamics.

There are some alternatives in the superheater modelling. One has to choose a model which is feedback linearizable, but it still displays dynamic and static properties of the system.

## REFERENCES

- [1] S. Dattatreya, "Adaptive gain improves coal fired boiler control," *Hydrocarb. Process*, pp 261-263, 1982.
- [2] B. Hogg, N. El-Rabaie, "Generalized predictive control of steam pressure in a drum boiler", *IEEE Trans. En. Conv.*, pp 485-592, 1990.
- [3] R.Hunt, R.Su, G.Meyer, "Global transformation of nonlinear systems" *IEEE Trans. on Automatic Control*, v. 28, 24-31, 1983.
- [4] A. Isidori, *Nonlinear control systems*. Springer London, 1995.
- [5] A. A. Kaya, "A critical review of boiler controls for improved efficiency," *Energy Engineering*, pp 36-51, 1990.
- [6] H. Nijmeier, A.J. van der Schaft, *Nonlinear Dynamical Control Systems*, Springer, New York, 1990.
- [7] J. Nomura, Y.Sato, "Adaptive optimal control of steam temperatures for thermal power plants," *IEEE Trans. En. Conv.*, pp 25-33, 1989.
- [8] J.B.Riggs, K.Curtner, W.Foslien, "Comparison of two advanced steam temperature controllers for coal-fired boilers," *Computers Chem. Eng.*, v. 19, pp 541-550, 1995.
- [9] W.Respondek, B.Jakubczyk, "On linearization of control systems," *Bull. Acad. Sci. Ser. Sci. Math.* 28, pp 517-522, 1980.
- [10] P. Profos, "Untersuchungen uber die optimale Einstellung der Ueberhitzer Temperaturreglers," *BWK*, v. 18, n. 7, pp326-332, 1966.