

A Four-Step Method to Design an Energy Management Strategy for Hybrid Vehicles

Yuan Zhu¹, Yaobin Chen², Guangyu Tian¹, Hao Wu¹, Quanshi Chen¹

¹State Key Laboratory of Automotive Safety and Energy

Department of Automotive Engineering, Tsinghua University, Beijing, 100084, P.R. China
yzhu@mail.tsinghua.edu.cn

²Department of Electrical and Computer Engineering, Purdue University at Indianapolis, IN 46202, USA
ychen@iupui.edu

ABSTRACT

This paper presents an innovative four-step method to analyze and design an optimal energy management strategy for a power split powertrain hybrid vehicle. A hybrid dynamical system theory is introduced to formulate the problem of hybrid vehicle control system that incorporates both continuous and discrete dynamics. The Sequential Quadratic Programming (SQP) method is proposed to optimize power distribution. The Dynamic Programming method is employed to solve the problem of the vehicle operating mode transitions. A rule-based system and a fuzzy rule system are developed based on the statistical numerical solutions. A genetic algorithm is applied to the simultaneous optimization of parameters of membership functions, weights of the rules and rule sets for the fuzzy rule system and parameters of the rule-based system. The simulation results illustrate the effectiveness and applicability of the proposed design method.

1 INTRODUCTION

Hybrid electric vehicles (HEVs) have attracted tremendous attention as a commercially viable alternative to either traditional vehicles or electric vehicles. A typical HEV has two different energy sources: a battery pack and an internal combustion engine. The effective operation of HEVs depends largely upon the sophisticated design of vehicle system controllers (VSC) with optimal energy management strategies (EMS) that command each subsystem to its best performance for the overall system efficiency. Due to the complexity of HEVs, the design of the EMS presents a considerable challenge to engineers.

The purpose of an EMS is to determine an optimal power distribution between the battery and the engine under diverse driving conditions such that multiple design objectives, such as high fuel economy and low emissions, can be achieved.

Many researchers^[1-7] have devoted their attention to the design of the EMS because of its importance to HEVs. Overall, the design approaches can be classified into four categories: 1) Rule-based methods based on engineers' experience, 2) Rigorous mathematical optimisation methods with a comprehensive performance index or cost function, 3) Dynamic Programming (DP) approach, and 4) Intelligent control techniques. A brief comparison of these four methods is given in Table 1.

Table 1. Comparison of the Four Methods

Method	Advantages	Disadvantages
Rule-based	simple, easy-to-use	hard to tune rules, intuitive thinking
Mathematical	matured optimization method (e.g., SQP)	not robust against disturbances, static optimization
Dynamic Programming	global optimization	time-consuming, the future driving profile is needed
Intelligent Control	practical, robust	difficult to obtain expert knowledge

Taking advantages of these four methods, this paper presents an innovative four-step method to analyze and design an optimal energy management strategy for a power split powertrain HEV, as described below:

Step 1. A hybrid dynamical system theory is used to formulate the HEV control system that incorporates both continuous and discrete dynamics.

Step 2. The Sequential Quadratic Programming (SQP) method is applied to optimize power distribution. The Dynamic Programming method is employed to solve the complex vehicle operating mode transition problem.

Step 3. A rule-based system and a fuzzy rule system are developed based on the statistical numerical solutions derived from Step 2.

Step 4. A Genetic Algorithm is applied to the simultaneous optimization of parameters of membership functions, weights of the rules and rule sets for the fuzzy rule system and parameters of the rule-based system.

2 HEV CONTROL SYSTEM FORMULATION

2.1 System Configuration

In this work, a power split powertrain system configuration of an HEV is considered, as shown in Figure 1. The planetary gear set can be viewed as a power split device that splits the engine output power to the driveline and to the generator. From the viewpoint of the electrical path (series hybrid), the portion of the power from the engine to the generator can be converted into electric energy. Then the electric motor draws the electric power provided by the battery and the generator to propel the vehicle. From the viewpoint of the mechanical path (parallel hybrid), another portion of the power from the

engine to the carrier to the ring gear to counter shaft can be used to drive the vehicle without energy transformation. The two power paths provide propulsion to the vehicle simultaneously and independently. As described above, by controlling the generator properly, the planetary gear set can serve as a pseudo continuous variable transmission (pseudo-CVT) between the engine and the ring gear that is eventually connected to the driven wheels.

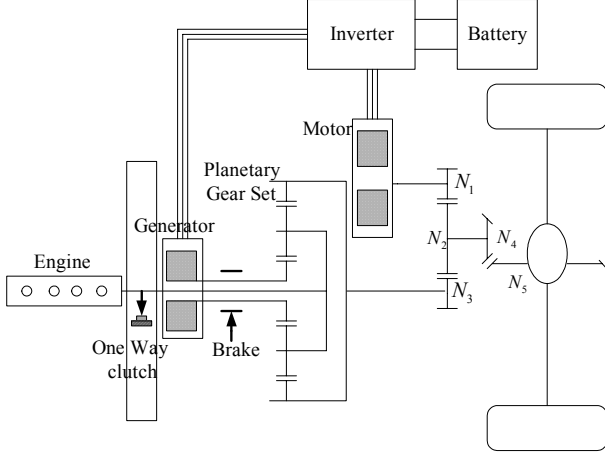

Figure 1. Power-split Powertrain System Configuration

2.2 Model for Hybrid Dynamical System

The many subsystems of the HEV can be combined into different vehicle operating modes with the cooperation of some factors, such as the one-way clutch between the engine and the carrier, the generator brake and the engine shutoff. Each vehicle operating mode can be considered as a state. The vehicle system jumps from one state to another in response to events or by generating events. In every state, the vehicle dynamic system is a specific continuous dynamic system, which has its own continuous state space and its differential or difference equation. The HEV system simultaneously exhibits several kinds of dynamic behaviours, such as continuous dynamics, switching and logic commands, discrete events and the interaction between continuous dynamics and the discrete event system (i.e. the events that get generated may depend on the continuous state). To cope with such complex systems, the hybrid dynamical system theory provides an effective and useful framework for HEV control system analysis and design.

The term “hybrid dynamical system” is used to describe systems that incorporate both continuous and discrete dynamics^[8]. The area of hybrid dynamical systems is a new, growing discipline that bridges control engineering, theoretical computer science and applied mathematics. However, in the area of hybrid dynamical systems, the main problem is the lack of formal mathematical tools for the analysis and design of such systems.

A hybrid dynamical system^[8-9], H , is a collection:

$$H = (Q, X, V, Y, Init, f, Inv, E, R, \Phi) \quad (1)$$

where, Q is a set of discrete variables and Q is countable;

X is a set of continuous variables;

V is a finite collection of input variables;

Y is a finite collection of output variables;

$Init \subseteq Q \times X$ is a set of initial states;

$f: Q \times X \times V \rightarrow \mathfrak{R}^n$ is an input-dependent vector field;

$Inv: Q \rightarrow 2^{X \times V}$ assigns to each $q \in Q$ an invariant set;

$E \subset Q \times Q$ is a collection of discrete transitions;

$R: E \times X \times V \rightarrow 2^X$ assigns to each $e = (q, q'') \in E$, $x \in X$ and $v \in V$ a reset relation;

$\phi: Q \times X \rightarrow 2^V$ assigns to each state a set of admissible inputs.

A high-level, simplified structure of the HEV control system is shown in Figure 2.

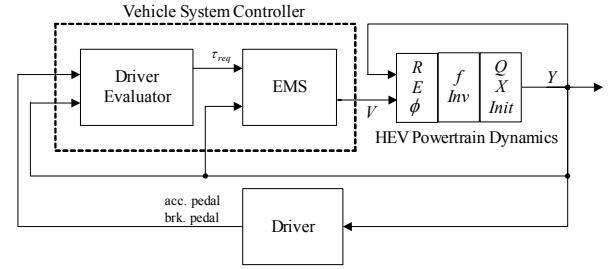

Figure 2. Structure of HEV Control System

The HEV dynamics was formulated using the hybrid dynamical system theory. The dynamical behaviour of the HEV can be described by a collection of ten sets.

Q is a set of countable discrete state variables with $q = \{q_1, q_2, q_3, q_4, q_5\} \in Q$, representing stand-still, vehicle creeping mode, power split mode, parallel hybrid mode and regenerative brake mode.

E is a collection of discrete transitions. Because the discrete states are usually a finite number of values, a finite graph can provide a good representation of the discrete transitions, as shown in Figure 3.

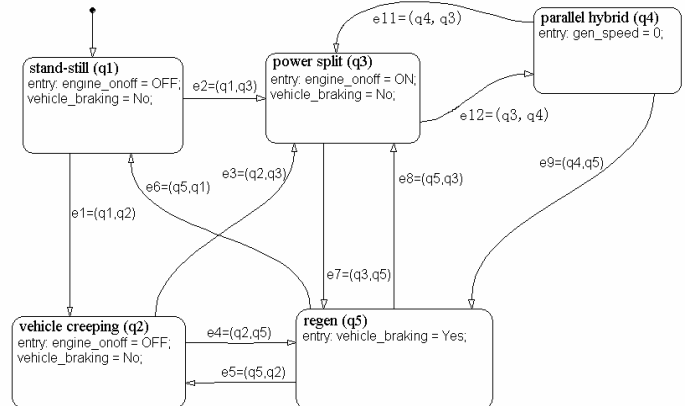

Figure 3. Transitions Between Vehicle Operating Modes

Each node in the graph represents a discrete state value, $q \in Q$. We associated an event $e \in E$ with a transition from node q to node q' . For example, when the event e_1 occurs, the simultaneous transition from q_1 to q_2 takes place consequently.

X is a set of continuous state variables defined by $x = \{\omega_e, \omega_r, \omega_g\} \in X$, respectively, representing the engine speed, the ring gear speed and the generator speed.

V is a finite collection of input variables and $V = V_D U V_C$. The continuous inputs are defined as $v_c = \{\tau_e, \tau_g, \tau_m\} \in V_C$, where τ_e, τ_g , and τ_m are the engine torque, the generator torque, and the motor torque, respectively. The discrete inputs are defined as $v_d = \{v_1, v_2\}$, where v_1 is the generator brake command and v_2 the engine on-off command.

Y is a finite collection of output variables and $Y = Y_D U Y_C$. The continuous outputs are $y_c = \{u, SOC, \omega_e, \omega_g\} \in Y_C$, where u is the vehicle speed, SOC the battery state-of-charge and ω_e and ω_g are the engine and generator speeds. The discrete output is $y_d = \{\text{vehicle_braking}\} \in \{\{\text{Yes}, \text{No}\}\} = Y_D$ which defines the vehicle braking status.

f is the input dependent vector field. The vehicle dynamics vary according to the different vehicle operating modes;

$$Inv(q) \rightarrow \begin{cases} \omega_e = 0, \omega_r = 0, v_2 = Engine_Off & \text{if } q = q_1 \\ \omega_e = 0, |\omega_r| \leq \omega_{r2max}, \tau_e = 0, v_2 = Engine_Off & \text{if } q = q_2 \\ \omega_{emin} \leq \omega_e \leq \omega_{emax}, |\omega_r| \leq \omega_{r3max}, |\omega_g| \leq \omega_{g3max} & \text{if } q = q_3 \\ \omega_{emin} \leq \omega_e \leq \omega_{emax}, |\omega_r| \leq \omega_{r4max}, & \text{if } q = q_4 \\ \omega_g = 0, v_1 = Genbrk_Engaged, \omega_g = 0 & \text{if } q = q_4 \end{cases} \quad (2)$$

$$R(e, x, v) \rightarrow \begin{cases} \omega_e = Idle_speed & \text{if } e = e_2, e_3 \\ \omega_g = 0 & \text{if } e = e_{12} \\ \omega_e = 0 & \text{if } e = e_5, e_6 \end{cases} \quad (3)$$

ϕ assigns to each state a set of admissible inputs. In each vehicle operating mode, the system input and state variables are subjected to constraints due to their physical limits and maximum operating capabilities. Hence it is necessary to impose certain inequality constraints on the state and control variables such as the engine speed, the battery state of charge (SOC), the battery power (P_{bat}), the motor torque, the generator torque, the engine torque, the generator speed and the motor speed.

According to the description above, the objective of the EMS design is to find the optimal input control sequence V and the discrete event (transition rule) E such that the design objective is achieved.

3 NUMERICAL SOLUTIONS TO POWER DISTRIBUTION AND TRANSITION RELATION

3.1 Power Distribution

Determining an optimal power distribution is a constrained nonlinear optimization problem. The overall objective is to optimize the total system efficiency while satisfying the performance requirements. For convenience, the battery (or electric) energy is usually converted into an equivalent amount of fuel consumption. In general, batteries can be modeled according to their electrochemical characteristics and empirical data^[10]. The battery resistance can be approximated by a function of the battery SOC and battery current. Thereafter, the total system efficiency^[10] of the HEV system is obtained as

$$\eta_{total} = \eta_e \left(\frac{\tau_{req} \omega_r}{\tau_e \omega_e} - \frac{(OCV - \sqrt{OCV^2 - 4P_{bat} R_{bat}}) OCV}{2R_{bat} \tau_e \omega_e} \right) \quad (4)$$

where,

τ_{req} —torque desired by driver

OCV —open circuit voltage

R_{bat} —battery resistance

P_{bat} —battery power

η_e —engine efficiency

In actual implementation of power distribution, the continuous control variables of the HEV transaxle are $v_c = \{\tau_e, \tau_g, \tau_m\}$. However, from a mathematical point of view, this paper introduces new control variables $v'_c = \{\gamma, P_{bat}\}$ so that the physical concept closely resembles conventional vehicles, where γ is the reduction ratio of the engine speed to the ring gear speed. Thus, the optimization problem can be recast as the following problem.

$$\begin{aligned} \max & \eta_{total}(\gamma, P_{bat}) \\ & \gamma, P_{bat} \\ \text{s.t. } & \phi, Inv \end{aligned} \quad (5)$$

The optimization problem aims to find a set of optimal parameters (γ, P_{bat}). Basically, these parameters are obtained by maximizing an objective function, subject to equality or inequality constraints and/or parameter boundaries using an appropriate optimization algorithm. The Sequential Quadratic Programming (SQP) is a good candidate for solving this optimization problem because of its robustness and iterative efficiency. In this work, the SQP method was used to solve this optimization problem. The results for the battery power (P_{bat}) in terms of the condition of a vehicle speed are given in Figure 4. In the figure, “*” represents the region where the optimal battery power is negative (charging). “+” shows that the optimal battery power is neutral (neither charging nor discharging). “o” denotes that the optimal battery power is positive (discharging). It is seen that the battery SOC and engine speed chart is divided into three areas by two lines. It is obvious that the inclination of the battery power is different in the three areas.

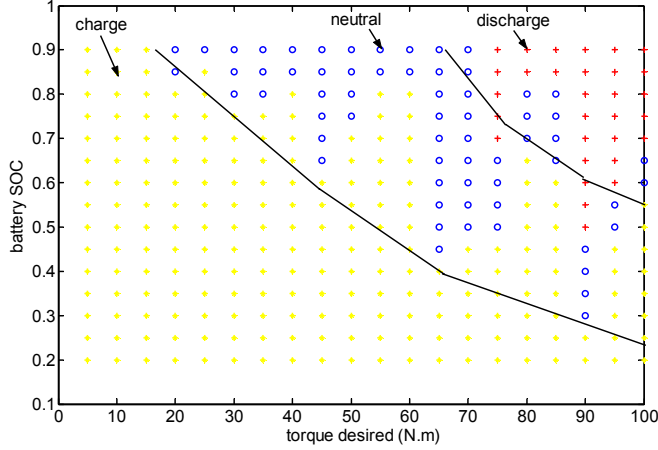

Figure 4. Results of the Power Distribution

3.2 Transition Relation for Vehicle Operating Modes

The goal of obtaining the transition relation for the vehicle operating modes is to find the causes that change the state from one to another. It is well known that the dynamic programming (DP)^[11-12] method has been proven very effective in tackling such complex dynamic optimization problems. The implementation of the DP method is usually divided into two steps. Firstly, the quantization and interpolation on the state and control variables are performed. Then the problem is formulated as a multi-stage decision problem, where the time variable is used to order the sequence according to Bellman's principle of optimality.

It is worth mentioning that the principle of optimality has been widely used in many application problems, such as simple optimal path problem, job allocation problems, and linear optimal control problems. In this work, the DP method is applied to find the optimal trajectory of vehicle operating modes. The objective function is chosen as follows,

$$J = \sum_{k=0}^{N-1} (\omega_e \tau_e \cdot g_e + P_{bat} \cdot \eta \cdot g_{e_average} + \delta \dot{\omega}_e^2) \Delta t \quad (6)$$

$$\eta = \begin{cases} 1/\eta_{discharge} & P_{bat} > 0 \\ \eta_{charge} & P_{bat} < 0 \end{cases}$$

where,

g_e — engine specific fuel consumption

$g_{e_average}$ — average engine specific fuel consumption

η — battery charging (or discharging) efficiency

This objective function represents a control strategy that determines the optimal vehicle operating mode and power distribution such that the total energy (fuel and battery energy) consumption is minimized while satisfying the desired driver torque and the vehicle driving performance. The objective function contains three components:

1) The engine fuel consumption. This term only represents the fuel consumption assuming the engine is rotating in a steady state.

2) The battery energy consumption. In this term the battery power is multiplied by the average engine specific fuel consumption in order to convert the electric energy consumption into the equivalent amount of fuel consumption. The sum of the first two terms represents the equivalent energy consumption in a unit time, which is used to measure the effective fuel economy.

3) The third term is used to compensate the extra fuel consumption for the engine acceleration when taking the engine dynamics into account. From the optimal control point of view, this term is used as an anti-jerk function. Here δ is the weight for the purpose of anti-jerk control.

Several typical drive cycles such as the EPA city duty cycle and the FTP75 were used for the numerical simulations. For a given initial SOC value, the DP method can be used to find the optimal trajectory of vehicle operating modes. The different initial battery SOC and various driving cycles may lead to many different numerical solutions that would cover all possible HEV operating scenarios. Figure 5 presents the optimal trajectories of operating points of the engine (ICE) and the vehicle operating modes (VOM) over the EPA city cycle when the initial battery SOC is chosen to be 0.68.

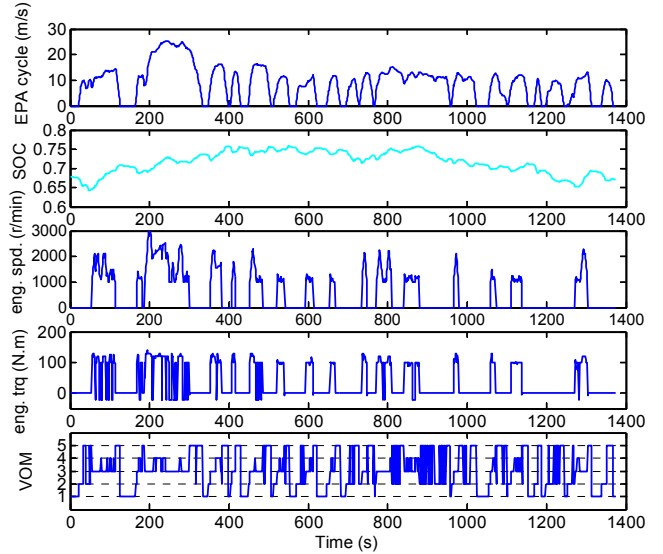

Figure 5. Numerical Results of DP optimization

The results show that the optimal control strategy tends to keep the battery SOC within the range of 65% ~ 75%. On one hand, this leaves enough capacity to handle an extended period of the battery discharge (such as during a long period acceleration) and enough "headroom" to absorb a long period of charging (such as during a long downhill). On the other hand, from the control point of view, the battery SOC is maintained near a balance point to ensure system stability. Therefore, it is felt that the optimization results are reliable and viable.

4 A RULE-BASED AND FUZZY RULE-BASED EMS

The SQP and dynamic programming approaches provide the optimal numerical solutions (power distribution and vehicle operating modes) to achieve the optimal design objective. However, these numerical solutions can not be implemented immediately in real-time driving. For real-time implementation of the EMS, an on-line scheme needs to be developed. A rule-based and fuzzy rule-based EMS are proposed on the basis of the analysis and investigation of the numerical solutions.

4.1 A Fuzzy Rule-based Power Distribution Strategy

Given the desired driver torque, a vehicle speed and a battery SOC, the optimal battery power for maximizing the total system efficiency can be obtained using the SQP method. Based on the statistical analysis of optimization results (Figure 4), we can apply the fuzzy logic technique to identify the battery power for a given driver power request (the product of the desired driver torque and the vehicle speed) and the battery SOC. The fuzzy rule system has two inputs and one output. One input is the Driver Power Request, defined by using three membership functions {Large, Medium, Small}. The other is the Battery SOC, defined by three membership functions {High, Medium, Low}. The output is Battery Power, which can be defined using five membership functions {Positive Large, Positive Small, Zero, Negative Small, Negative Large}. The fuzzy rules can be established based on related heuristic knowledge and the SQP optimization results, as shown in Table 2.

Table 2. Fuzzy Rule for Power Distribution

Premise		Consequence
Driver Power Request	Battery SOC	Battery Power
Large	High	Positive Large
Large	Medium	Positive Small
Large	Low	Zero
Medium	High	Positive Small
Medium	Medium	Zero
Medium	Low	Negative Small
Small	High	Zero
Small	Medium	Negative Small
Small	Low	Negative Large

4.2 A Rule-based Vehicle Operating Mode Transition System

The twelve discrete events are defined in Figure 3. In the real time operation, we need to determine the transition rules for each discrete event based on the DP optimization results.

For example, in order to acquire the transition rule for event e_3 , we collected all the vehicle status points (cycle points as shown in Figure 6) regarding the vehicle creeping mode.

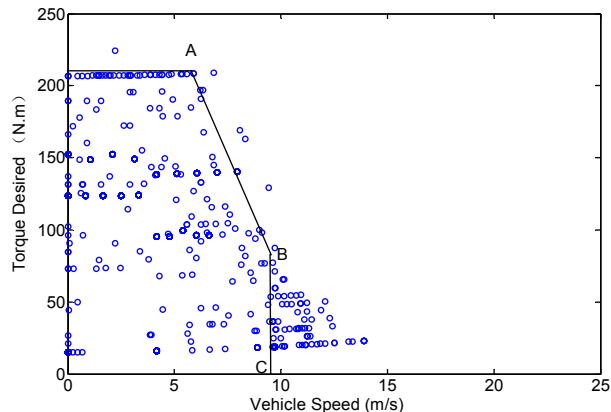

Figure 6. Vehicle Status Points Regarding the Vehicle Creeping Mode

There is a clear borderline in Figure 6. Once the three points A, B and C are specified, the borderline is determined. The three points A, B and C and the x and y axis constitute a close region. When the HEV goes outside of the region, the vehicle system controller will send the command $v_2 = Engine_ON$ to the HEV powertrain system. Accordingly, the vehicle operating mode goes to the power split mode from the vehicle creeping mode, that is, event e_3 occurs. The coordinates of points A, B and C are initialized by the distribution of the vehicle status points derived from the DP optimization results. Human experience is likewise important to initialize the coordinates of these three points because these parameters are tuned by trial and error. By ways of exception, if the battery SOC approaches the specified lower limit, the vehicle system controller will start up the engine to charge the battery regardless of the vehicle status.

In principle, we can obtain all the transition rules by analyzing the DP optimization results. It should be noted that the transition between the power split mode and the parallel hybrid mode depends on the absolute generator speed.

5 OPTIMIZATION OF PARAMETERS OF THE RULE-BASED AND FUZZY RULE-BASED EMS

In general, the rule-based and fuzzy rule-based systems represent a pragmatic engineering approach to the design of EMSs. However, the parameters of the rule-based and fuzzy rule-based systems lack precision and need to be improved mathematically for better system performance.

Genetic algorithms^[13-14] are general-purpose optimization algorithms with a probabilistic component that provide a means to search poorly understood, irregular spaces. In this work, a Genetic Algorithm (GA) is applied to the simultaneous optimization of the parameters of the rule-based and fuzzy rule-based systems.

When optimizing a rule-based and fuzzy rule-based system using the GA, the first important consideration is how to encode all the optimized parameters into the chromosome. For example, it is necessary to encode the parameters of the coordinates of the points A, B and C to represent a part of rule-based system. The parameters of the membership functions should also be encoded into the chromosome. Based on the static models for the HEV control system, the effectiveness of the EMS was analyzed and compared. This paper only presents some simulation results without details regarding the function of the generator brake because the generator brake is a relatively new device in comparison with the similar HEV Prius. Figure 7 illustrates the fuel consumption versus the different critical generator braking speeds over the ECE 15 duty cycle.

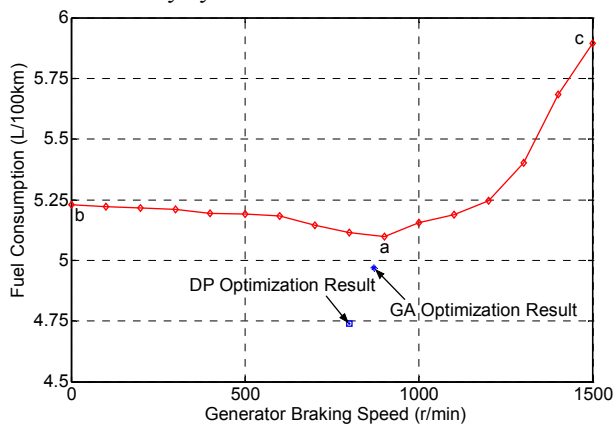

Figure 7. Fuel Consumption As a Function of the Critical Generator Braking Speed

By comparing the fuel consumption of point A with that of point B, point A can decrease fuel consumption by 2.5% over the ECE15 duty cycle. This means that the generator brake can improve the fuel economy by 2.5% under the appropriate control. The difference in fuel consumption between point A and DP optimization result demonstrates how much the current EMS can improve HEVs fuel efficiency to its maximal capability.

Fuel consumption can be decreased by 2.4% via the optimization of the rule-based and fuzzy rule-based EMS using the GA. However, the GA optimization result can only approach but not reach the DP optimization result.

6 SUMMARY

A four-step method to design and analyze an optimal EMS for a power split hybrid electric vehicle was presented. By considering the HEV dynamics that incorporate both continuous and discrete dynamics, the problem was cast as an optimal control problem for a hybrid dynamical system. The SQP and dynamic programming-based method were applied to obtain numerical solutions. As a pragmatic engineering approach, a rule-based and fuzzy rule-based EMS was developed by carefully examining the SQP and DP optimization results. The parameters of the EMS were

finalized using the Genetic Algorithm. Computer simulation results revealed the effectiveness of the proposed four-step method and the resulting EMS.

Acknowledgement

The authors would like to thank Prof. Huei Peng of the University of Michigan and the Technical Specialist Ming.L. Kuang of the Ford Motor Company for the technical discussions and helpful suggestions.

References

- [1] Jakob Seiler, Dierk Shröder. "Hybrid vehicle operating strategies", in *Proc. of EVS15*, Bruxelles, 1998
- [2] V. Galdi, L. Ippolito, A. Piccolo, et al. "Multiobjective optimization for fuel economy and emissions of HEV using the goal-attainment method", in *Proceedings of EVS18*, Berlin, October, 2001.
- [3] S. Delprat, G. Paganelli, T.M. Guerra, et al. "Algorithmic optimization tool for evaluation of HEV control strategies", in *Proc. of EVS16*, Beijing, October 12-16, 1999
- [4] Stephane Rimaux, Michel Delhom, Emmanuel Combes. "Hybrid Vehicle Powertrain: Modeling and Control", in *Proc. of EVS16*, Beijing, 1999
- [5] A. Brahma, Y. Guezennec, G.Rizzoni. "Optimal Energy Management in Series Hybrid Electric Vehicles", in *Proc. of ACC*, 2000
- [6] Chan-Chiao Lin, Jun-Mo Kang, J.W. Grizzle and Huei Peng. "Energy Management Strategy for a Parallel Hybrid Electric Truck", in *Proc. of American Control Conference*, Arlington, VA, Jun. 25-27, 2001
- [7] Zhang Rongjun, Chen Yaobin. "Control of Hybrid Dynamical Systems for Electric Vehicles", in *Proc. of American Control Conference*, 2001
- [8] John Lygeros. "Hierarchical Hybrid Control of Large Scale Systems". Ph.D. dissertation, University of California at Berkeley, 1996
- [9] Zhu Yuan, Chen Yaobin, et.al. "Analysis and Design of an Optimal Energy Management and Control System for Hybrid Electric Vehicles", in *Proc. of EVS19*, Busan, Korea, 2002
- [10] Zhu Yuan. "A Four-step Method to Design an Energy Management Strategy for Hybrid Vehicles". Ph.D. dissertation, Tsinghua University, 2003
- [11] Bellman, R.E. *Dynamic programming*, Princeton University Press, 1957
- [12] Arthur E. Bryson. *Dynamic Optimization*, Addison Wesley Longman, Inc., California 1999
- [13] Abdollah Homaifar, Ed McCormick. "Simultaneous Design of Membership Functions and Rule Sets for Fuzzy Controllers Using Genetic Algorithms", *IEEE Trans. on Fuzzy Systems*, 1995, 3(2): 129~139
- [14] Yuhui Shi, Russell Eberhart, Yaobin Chen. "Implementation of Evolutionary Fuzzy Systems", *IEEE Trans. on Fuzzy Systems*, 1999, 7(2): 109~119